

# Electronics Workbench™

## Multisim™ 9 Simulation and Capture

*User Guide*

## **Worldwide Technical Support and Product Information**

ni.com

### **National Instruments Corporate Headquarters**

11500 North Mopac Expressway Austin, Texas 78759-3504 USA Tel: 512 683 0100

### **Worldwide Offices**

Australia 1800 300 800, Austria 43 0 662 45 79 90 0, Belgium 32 0 2 757 00 20, Brazil 55 11 3262 3599,  
Canada 800 433 3488, China 86 21 6555 7838, Czech Republic 420 224 235 774, Denmark 45 45 76 26 00,  
Finland 385 0 9 725 725 11, France 33 0 1 48 14 24 24, Germany 49 0 89 741 31 30, India 91 80 41190000,  
Israel 972 0 3 6393737, Italy 39 02 413091, Japan 81 3 5472 2970, Korea 82 02 3451 3400,  
Lebanon 961 0 1 33 28 28, Malaysia 1800 887710, Mexico 01 800 010 0793, Netherlands 31 0 348 433 466,  
New Zealand 0800 553 322, Norway 47 0 66 90 76 60, Poland 48 22 3390150, Portugal 351 210 311 210,  
Russia 7 095 783 68 51, Singapore 1800 226 5886, Slovenia 386 3 425 4200, South Africa 27 0 11 805 8197,  
Spain 34 91 640 0085, Sweden 46 0 8 587 895 00, Switzerland 41 56 200 51 51, Taiwan 886 02 2377 2222,  
Thailand 662 278 6777, United Kingdom 44 0 1635 523545

For further support information, refer to the [Technical Support Resources and Professional Services](#) page. To comment on National Instruments documentation, refer to the National Instruments Web site at [ni.com/info](http://ni.com/info) and enter the info code `feedback`.

# Important Information

---

## Warranty

The media on which you receive National Instruments software are warranted not to fail to execute programming instructions, due to defects in materials and workmanship, for a period of 90 days from date of shipment, as evidenced by receipts or other documentation. National Instruments will, at its option, repair or replace software media that do not execute programming instructions if National Instruments receives notice of such defects during the warranty period. National Instruments does not warrant that the operation of the software shall be uninterrupted or error free.

A Return Material Authorization (RMA) number must be obtained from the factory and clearly marked on the outside of the package before any equipment will be accepted for warranty work. National Instruments will pay the shipping costs of returning to the owner parts which are covered by warranty.

National Instruments believes that the information in this document is accurate. The document has been carefully reviewed for technical accuracy. In the event that technical or typographical errors exist, National Instruments reserves the right to make changes to subsequent editions of this document without prior notice to holders of this edition. The reader should consult National Instruments if errors are suspected. In no event shall National Instruments be liable for any damages arising out of or related to this document or the information contained in it.

EXCEPT AS SPECIFIED HEREIN, NATIONAL INSTRUMENTS MAKES NO WARRANTIES, EXPRESS OR IMPLIED, AND SPECIFICALLY DISCLAIMS ANY WARRANTY OF MERCHANTABILITY OR FITNESS FOR A PARTICULAR PURPOSE. CUSTOMER'S RIGHT TO RECOVER DAMAGES CAUSED BY FAULT OR NEGLIGENCE ON THE PART OF NATIONAL INSTRUMENTS SHALL BE LIMITED TO THE AMOUNT THEREFORE PAID BY THE CUSTOMER. NATIONAL INSTRUMENTS WILL NOT BE LIABLE FOR DAMAGES RESULTING FROM LOSS OF DATA, PROFITS, USE OF PRODUCTS, OR INCIDENTAL OR CONSEQUENTIAL DAMAGES, EVEN IF ADVISED OF THE POSSIBILITY THEREOF. This limitation of the liability of National Instruments will apply regardless of the form of action, whether in contract or tort, including negligence. Any action against National Instruments must be brought within one year after the cause of action accrues. National Instruments shall not be liable for any delay in performance due to causes beyond its reasonable control. The warranty provided herein does not cover damages, defects, malfunctions, or service failures caused by owner's failure to follow the National Instruments installation, operation, or maintenance instructions; owner's modification of the product; owner's abuse, misuse, or negligent acts; and power failure or surges, fire, flood, accident, actions of third parties, or other events outside reasonable control.

## Copyright

Under the copyright laws, this publication may not be reproduced or transmitted in any form, electronic or mechanical, including photocopying, recording, storing in an information retrieval system, or translating, in whole or in part, without the prior written consent of National Instruments Corporation.

National Instruments respects the intellectual property of others, and we ask our users to do the same. NI software is protected by copyright and other intellectual property laws. Where NI software may be used to reproduce software or other materials belonging to others, you may use NI software only to reproduce materials that you may reproduce in accordance with the terms of any applicable license or other legal restriction.

BSIM3 and BSIM4 are developed by the Device Research Group of the Department of Electrical Engineering and Computer Science, University of California, Berkeley and copyrighted by the University of California.

## Trademarks

National Instruments, NI, ni.com, and LabVIEW are trademarks of National Instruments Corporation. Refer to the *Terms of Use* section on [ni.com/legal](http://ni.com/legal) for more information about National Instruments trademarks.

Other product and company names mentioned herein are trademarks or trade names of their respective companies.

Members of the National Instruments Alliance Partner Program are business entities independent from National Instruments and have no agency, partnership, or joint-venture relationship with National Instruments.

## Patents

For patents covering National Instruments products, refer to the appropriate location: **Help»Patents** in your software, the `patents.txt` file on your CD, or [ni.com/patents](http://ni.com/patents).

Some portions of this product are protected under United States Patent No. 6,560,572.

## WARNING REGARDING USE OF NATIONAL INSTRUMENTS PRODUCTS

(1) NATIONAL INSTRUMENTS PRODUCTS ARE NOT DESIGNED WITH COMPONENTS AND TESTING FOR A LEVEL OF RELIABILITY SUITABLE FOR USE IN OR IN CONNECTION WITH SURGICAL IMPLANTS OR AS CRITICAL COMPONENTS IN ANY LIFE SUPPORT SYSTEMS WHOSE FAILURE TO PERFORM CAN REASONABLY BE EXPECTED TO CAUSE SIGNIFICANT INJURY TO A HUMAN.

(2) IN ANY APPLICATION, INCLUDING THE ABOVE, RELIABILITY OF OPERATION OF THE SOFTWARE PRODUCTS CAN BE IMPAIRED BY ADVERSE FACTORS, INCLUDING BUT NOT LIMITED TO FLUCTUATIONS IN ELECTRICAL POWER SUPPLY, COMPUTER HARDWARE MALFUNCTIONS, COMPUTER OPERATING SYSTEM SOFTWARE FITNESS, FITNESS OF COMPILERS AND DEVELOPMENT SOFTWARE USED TO DEVELOP AN APPLICATION, INSTALLATION ERRORS, SOFTWARE AND HARDWARE COMPATIBILITY PROBLEMS, MALFUNCTIONS OR FAILURES OF ELECTRONIC MONITORING OR CONTROL DEVICES, TRANSIENT FAILURES OF ELECTRONIC SYSTEMS (HARDWARE AND/OR SOFTWARE), UNANTICIPATED USES OR MISUSES, OR ERRORS ON THE PART OF THE USER OR APPLICATIONS DESIGNER (ADVERSE FACTORS SUCH AS THESE ARE HEREAFTER COLLECTIVELY TERMED "SYSTEM FAILURES"). ANY APPLICATION WHERE A SYSTEM FAILURE WOULD CREATE A RISK OF HARM TO PROPERTY OR PERSONS (INCLUDING THE RISK OF BODILY INJURY AND DEATH) SHOULD NOT BE RELIANT SOLELY UPON ONE FORM OF ELECTRONIC SYSTEM DUE TO THE RISK OF SYSTEM FAILURE. TO AVOID DAMAGE, INJURY, OR DEATH, THE USER OR APPLICATION DESIGNER MUST TAKE REASONABLY PRUDENT STEPS TO PROTECT AGAINST SYSTEM FAILURES, INCLUDING BUT NOT LIMITED TO BACK-UP OR SHUT DOWN MECHANISMS. BECAUSE EACH END-USER SYSTEM IS CUSTOMIZED AND DIFFERS FROM NATIONAL INSTRUMENTS' TESTING

PLATFORMS AND BECAUSE A USER OR APPLICATION DESIGNER MAY USE NATIONAL INSTRUMENTS PRODUCTS IN COMBINATION WITH OTHER PRODUCTS IN A MANNER NOT EVALUATED OR CONTEMPLATED BY NATIONAL INSTRUMENTS, THE USER OR APPLICATION DESIGNER IS ULTIMATELY RESPONSIBLE FOR VERIFYING AND VALIDATING THE SUITABILITY OF NATIONAL INSTRUMENTS PRODUCTS WHENEVER NATIONAL INSTRUMENTS PRODUCTS ARE INCORPORATED IN A SYSTEM OR APPLICATION, INCLUDING, WITHOUT LIMITATION, THE APPROPRIATE DESIGN, PROCESS AND SAFETY LEVEL OF SUCH SYSTEM OR APPLICATION.

---

# Preface

Congratulations on choosing Multisim 9 from Electronics Workbench. We are confident that it will deliver years of increased productivity and superior designs.

Electronics Workbench is the world's leading supplier of circuit design tools. Our products are used by more customers than those of any other EDA vendor, so we are sure you will be pleased with the value delivered by Multisim 9, and by any other Electronics Workbench products you may select.

## Documentation Conventions

When Multisim guides refer to a toolbar button, an image of the button appears in the left column.



When you see the icon in the left column, the functionality described is only available in certain versions of Multisim, or to users who have purchased optional modules. Please refer to the release notes for details.

Multisim guides use the convention **Menu/Item** to indicate menu commands. For example, “**File/Open**” means choose the **Open** command from the **File** menu.

Multisim guides use the convention of an arrow (➤) to indicate the start of procedural information.

Multisim guides use the construction CTRL-KEY and ALT-KEY to indicate when you need to hold down the “Ctrl” or “Alt” key on your keyboard and press another key.

## The Multisim 9 Documentation Set

Multisim 9 documentation consists of this *User Guide*, the *Component Reference Guide* and online help. All Multisim 9 users receive PDF versions of the *User Guide* and the *Component Reference Guide*.

### User Guide

The *User Guide* describes Multisim and its many functions in detail. It is organized based on the stages of circuit design, and explains all aspects of Multisim, in detail. It also offers an introductory tutorial that takes you through the stages of circuit design, simulation, analysis and reporting.

---

## Online Help

Multisim offers a full helpfile system to support your use of the product.

Choose **Help/Multisim Help** to display the helpfile that explains the Multisim program in detail, or choose **Help/Component Reference** to display the helpfile that contains details on the components families provided with Multisim. Both are standard Windows helpfiles, offering a table of contents and index.

In addition, you can display context-sensitive help by pressing F1 from any command or window, or by clicking the **Help** button on any dialog box that offers it.

## Adobe PDF Files

The *User Guide* and *Component Reference Guide* are provided on the documentation CD as Adobe PDF files. To open PDF files, you will need Adobe's free Acrobat Reader program, available for download at [www.adobe.com](http://www.adobe.com).

## License Agreement

Please read the license agreement found at [www.electronicworkbench.com](http://www.electronicworkbench.com) carefully before installing and using the software contained in this package. By installing and using the software, you are agreeing to be bound by the terms of this license. If you do not agree to the terms of this license, simply return the unused software within ten days to the place where you obtained it and your money will be refunded.

# Table of Contents

## 1. Installing Multisim

1.1	Installation Requirements . . . . .	1-2
1.2	Installation Overview . . . . .	1-3
1.3	Installing Multisim 9 . . . . .	1-3
1.3.1	Before Installing Multisim 9 . . . . .	1-3
1.3.2	Single User Edition . . . . .	1-4
1.3.2.1	Installing the Single User Edition . . . . .	1-4
1.3.2.2	Requesting a Release Code for the Single User Version . . . . .	1-4
1.3.3	Multi-Station Standalone Edition . . . . .	1-5
1.3.4	Network Version . . . . .	1-5
1.3.4.1	Installing the Network Edition . . . . .	1-6
1.3.4.2	Entering the Release Code for the Network Edition . . . . .	1-7
1.3.4.3	Workstation Setup . . . . .	1-7
1.3.4.4	Setting User Permissions . . . . .	1-7
1.3.5	Changing Server Name and/or Port Number After Client Installation. . . . .	1-10
1.4	Network License Server . . . . .	1-10
1.4.1	Administering the Network License Server . . . . .	1-10
1.4.2	Administering Fixed Seat Licenses. . . . .	1-11
1.4.3	Reviewing License Server Events . . . . .	1-12
1.4.4	Troubleshooting . . . . .	1-12
1.5	Support and Upgrade . . . . .	1-14
1.5.1	Checking for Updates . . . . .	1-14
1.5.2	Installing Updates . . . . .	1-14
1.5.3	Viewing Messages . . . . .	1-15
1.5.4	Changing Settings . . . . .	1-15
1.6	Uninstalling Multisim 9 . . . . .	1-16
1.6.1	Uninstalling the Single User Version . . . . .	1-16
1.7	Uninstalling SUU . . . . .	1-16
1.8	Uninstalling a Site Version . . . . .	1-17
1.8.1	Uninstalling Standalone Multi-Station Installation . . . . .	1-17
1.8.2	Uninstalling Network Installation . . . . .	1-17
1.8.3	Uninstalling Combination Standalone Multi-Station and Network Installations . . . . .	1-17
1.9	Uninstalling NLS . . . . .	1-18

---

## 2. Multisim Tutorial

2.1	The Electronics Workbench Suite .....	2-1
2.2	Multisim 9 Tutorial .....	2-2
2.2.1	Schematic Capture .....	2-3
2.2.2	Simulation .....	2-9

## 3. User Interface

3.1	Introduction to the Multisim Interface .....	3-3
3.2	Toolbars .....	3-4
3.2.1	Standard Toolbar .....	3-5
3.2.2	Main Toolbar .....	3-6
3.2.3	View Toolbar .....	3-7
3.2.4	Components Toolbar .....	3-8
3.2.5	Virtual Toolbar .....	3-9
3.2.6	Graphic Annotation Toolbar .....	3-10
3.2.7	Instruments Toolbar .....	3-11
3.3	Using the Pop-up Menus .....	3-12
3.3.1	Pop-up From Circuit Window, with no Component Selected .....	3-13
3.3.2	Pop-up From a Selected Component or Instrument .....	3-15
3.3.3	Pop-up From a Selected Wire .....	3-17
3.3.4	Pop-up From a Selected Text Block or Graphic .....	3-17
3.3.5	Pop-up From a Title Block .....	3-18
3.3.6	Pop-up from a Comment or Measurement Probe .....	3-19
3.4	Setting Schematic Capture Preferences .....	3-20
3.4.1	Using the Preferences Dialog Box .....	3-20
3.4.1.1	Preferences - Paths Tab .....	3-21
3.4.1.2	Preferences - Save Tab .....	3-22
3.4.1.3	Preferences - Parts Tab .....	3-23
3.4.1.4	Preferences - General Tab .....	3-24
3.4.2	Using the Sheet Properties Dialog Box .....	3-25
3.4.2.1	Sheet Properties - Circuit Tab .....	3-26
3.4.2.2	Sheet Properties - Workspace Tab .....	3-28
3.4.2.3	Sheet Properties - Wiring Tab .....	3-29
3.4.2.4	Sheet Properties - Font Tab .....	3-30
3.4.2.5	Sheet Properties - PCB Tab .....	3-32
3.4.2.6	Sheet Properties - Visibility Tab .....	3-33



---

3.5	Design Toolbox .....	3-34
3.5.1	Visibility Tab .....	3-34
3.5.2	Hierarchy Tab .....	3-35
3.6	Customizing the Interface .....	3-37
3.6.1	Commands tab .....	3-38
3.6.2	Toolbars tab .....	3-39
3.6.3	Keyboard tab .....	3-40
3.6.4	Menu tab .....	3-41
3.6.5	Options tab .....	3-42
3.6.6	Customization Pop-up Menus .....	3-42
3.6.7	Other Customization Options .....	3-43

## 4. Schematic Capture - Basics

4.1	Introduction to Schematic Capture .....	4-3
4.2	Working with Multiple Circuit Windows .....	4-3
4.3	Selecting Components from the Database .....	4-3
4.4	Placing Components .....	4-4
4.4.1	Using the place component browser .....	4-4
4.4.1.1	Multisection Components .....	4-7
4.4.1.2	Rotating/flipping a part during placement .....	4-9
4.4.1.3	Other buttons .....	4-9
4.4.2	Placing Virtual Components .....	4-9
4.4.2.1	Virtual component toolbars .....	4-10
4.4.3	Using the In Use List .....	4-13
4.4.4	Selecting Placed Components .....	4-13
4.4.5	Moving a Placed Component .....	4-15
4.4.6	Copying a Placed Component .....	4-16
4.4.7	Replacing a Placed Component .....	4-17
4.4.8	Controlling Component Color .....	4-18
4.5	Wiring Components .....	4-18
4.5.1	Wiring Components Automatically .....	4-19
4.5.1.1	Autowire of Touching Pins .....	4-20
4.5.2	Wiring Components Manually .....	4-22
4.5.3	Combining Automatic and Manual Wiring .....	4-23
4.5.4	Marking Pins for No Connection .....	4-23
4.5.5	Placing Wires Directly Onto Workspace .....	4-26
4.5.6	Setting Wiring Preferences .....	4-26
4.5.7	Modifying the Wire Path .....	4-27

---

4.5.8	Controlling Wire Color	4-27
4.5.9	Moving a Wire	4-28
4.5.10	Virtual Wiring	4-28
4.6	Manually Adding a Junction (Connector)	4-29
4.7	Rotating/Flipping Placed Components	4-30
4.8	Finding Components in Your Circuit	4-32
4.9	Labeling	4-33
4.9.1	Modifying Component Labels and Attributes	4-34
4.9.2	Modifying Net Names	4-35
4.9.3	Adding a Title Block	4-36
4.9.3.1	Entering the Title Block Contents	4-37
4.9.4	Adding Miscellaneous Text	4-39
4.9.5	Adding a Comment	4-40
4.9.6	Graphic Annotation	4-43
4.9.7	Capturing Screen Area	4-45
4.10	Circuit Description Box	4-47
4.10.1	Formatting the Circuit Description Box	4-47
4.10.1.1	Formatting Circuit Description Box Text	4-48
4.10.1.2	Paragraph Dialog Box	4-48
4.10.1.3	Tabs Dialog Box	4-49
4.10.1.4	Date and Time Dialog Box	4-49
4.10.1.5	Options Dialog Box	4-50
4.10.1.6	Insert Object Dialog Box	4-50
4.10.2	Scrolling with Events During Simulation	4-51
4.10.2.1	Scrolling Text During Simulation	4-51
4.10.2.2	Playing a Video Clip	4-53
4.10.2.3	Description Label Dialog Box	4-55
4.10.2.4	Edit Labels Dialog Box	4-56
4.10.2.5	Other Actions	4-57
4.10.3	Description Edit Bar	4-57
4.11	Linking a Form to a Circuit	4-59
4.11.1	Creating Forms	4-59
4.11.2	Setting Form Submission Options	4-60
4.11.3	Completing Forms	4-61
4.12	Printing the Circuit	4-62

---

## 5. Schematic Capture - Advanced Functions

5.1	Placed Component Properties . . . . .	5-2
5.1.1	Displaying Identifying Information about a Placed Component . . . . .	5-2
5.1.2	Viewing a Placed Component's Value/Model . . . . .	5-3
5.1.2.1	Real Components . . . . .	5-3
5.1.2.2	Edit Model Dialog Box . . . . .	5-5
5.1.2.3	Edit Footprint Dialog Box . . . . .	5-6
5.1.2.4	Virtual Components . . . . .	5-7
5.1.3	Controlling How a Placed Component is Used in Analyses . . . . .	5-7
5.2	The Spreadsheet View . . . . .	5-9
5.2.1	Spreadsheet View Results Tab . . . . .	5-9
5.2.2	Spreadsheet View Nets Tab . . . . .	5-10
5.2.3	Spreadsheet View Components Tab . . . . .	5-11
5.2.4	Spreadsheet View PCB Layers Tab . . . . .	5-14
5.2.5	Spreadsheet View Buttons . . . . .	5-14
5.3	Title Block Editor . . . . .	5-15
5.3.1	Enter Text Dialog Box . . . . .	5-17
5.3.2	Placing Fields . . . . .	5-18
5.3.2.1	Field Codes . . . . .	5-20
5.3.3	Title Block Editor Spreadsheet View . . . . .	5-21
5.3.4	Title Block Editor Menus . . . . .	5-22
5.3.4.1	File Menu . . . . .	5-22
5.3.4.2	Edit Menu . . . . .	5-23
5.3.4.3	View Menu . . . . .	5-24
5.3.4.4	Fields Menu . . . . .	5-25
5.3.4.5	Graphics Menu . . . . .	5-27
5.3.4.6	Tools Menu . . . . .	5-28
5.3.4.7	Help Menu . . . . .	5-28
5.3.4.8	Pop-up Menus . . . . .	5-28
5.3.5	Toolbars . . . . .	5-29
5.3.5.1	Standard Toolbar . . . . .	5-29
5.3.5.2	Zoom Toolbar . . . . .	5-30
5.3.5.3	Draw Tools Toolbar . . . . .	5-31
5.3.5.4	Drawing Toolbar . . . . .	5-32
5.4	Electrical Rules Checking . . . . .	5-34
5.4.1	ERC Options Tab . . . . .	5-37
5.4.1.1	Clearing ERC Markers . . . . .	5-38
5.4.2	ERC Rules Tab . . . . .	5-39
5.4.3	Component's Pins Tab . . . . .	5-41

---

## 6. Working with Larger Designs

6.1	Flat Multi-sheet Design	6-2
6.1.1	Delete Multi-page Dialog Box	6-3
6.2	Hierarchical Design	6-3
6.2.1	Nested Circuits	6-4
6.2.2	Component Numbering in Nested Circuits	6-5
6.2.3	Net Numbering in Nested Circuits	6-6
6.2.4	Global Nets	6-6
6.2.5	Adding a Hierarchical Block	6-7
6.2.5.1	Placing a HB from an Existing File	6-8
6.2.5.2	Replacing Components with an HB	6-9
6.2.6	Adding a Subcircuit	6-9
6.2.6.1	Replacing Components with a SC	6-11
6.2.7	Viewing Parent Sheet	6-11
6.3	Renaming Component Instances	6-11
6.3.1	Reference Designator Prefix Setup Dialog	6-13
6.4	Buses	6-16
6.4.1	Placing a Bus	6-18
6.4.1.1	Placing a bus across Multi-pages	6-19
6.4.1.2	Connecting Buses to HB/SCs	6-19
6.4.2	Bus Properties	6-21
6.4.2.1	Adding buslines to a Bus	6-21
6.4.2.2	Deleting Buslines from a Bus	6-23
6.4.2.3	Renaming Buslines in a Bus	6-23
6.4.3	Merging Buses	6-24
6.4.4	Wiring to a Bus	6-25
6.4.5	Bus Vector Connect	6-27
6.5	Variants	6-34
6.5.1	Setting Up Variants	6-34
6.5.2	Placing Parts in Variants	6-37
6.5.2.1	Assigning Variant Status to Components	6-38
6.5.2.2	Assigning Variant Status to Nested Circuits	6-43
6.5.2.3	Setting the Active Variant for Simulation	6-44
6.6	Project Management and Version Control	6-47
6.6.1	Setting up Projects	6-48
6.6.2	Working with Projects	6-49
6.6.3	Working with Files Contained in Projects	6-50
6.6.4	Version Control	6-51

---

## 7. Components

7.1	Structure of the Component Database	7-2
7.1.1	Database Levels	7-2
7.1.2	Classification of Components in the Database	7-3
7.2	Locating Components in the Database	7-3
7.2.1	Browsing for Components	7-4
7.2.2	Searching for Components	7-4
7.3	Types of Information Stored for Components	7-6
7.3.1	Pre-Defined Fields	7-6
7.3.1.1	General Information	7-7
7.3.2	User Fields	7-7
7.4	Component Nominal Values and Tolerances	7-7
7.5	Managing the Database	7-8
7.5.1	Filtering Displayed Components	7-10
7.5.2	Managing Families	7-11
7.5.3	Modifying User Field Titles	7-12
7.5.4	Deleting Components	7-13
7.5.5	Copying Components	7-14
7.5.6	Saving Placed Components	7-16
7.5.7	Moving Components Between Databases	7-16
7.5.8	Displaying Database Information	7-17
7.5.9	Editing Components	7-17
7.6	Converting 2001 or V7 Databases	7-18
7.7	Updating Components from Databases	7-19
7.8	Merging Databases	7-20

## 8. Component Editing

8.1	Introduction to Component Editing	8-2
8.2	Adding Components with the Component Wizard	8-4
8.2.1	Using an Existing Symbol File	8-11
8.3	Editing Components	8-12
8.4	Editing a Component's General Properties	8-14

---

8.5	Editing a Component's Symbol . . . . .	8-15
8.5.1	Copying a Component's Symbol . . . . .	8-16
8.5.1.1	Using "Copy To..." . . . . .	8-16
8.5.2	Creating and Editing a Component's Symbol with the Symbol Editor . . .	8-17
8.5.2.1	Symbol Editor Spreadsheet View . . . . .	8-19
8.5.2.2	Working with the Symbol Editor . . . . .	8-22
8.5.2.3	Enter Text Dialog Box . . . . .	8-26
8.5.2.4	In-Place Edit Mode . . . . .	8-26
8.5.2.5	Symbol Editor Menus . . . . .	8-27
8.5.2.6	Toolbars . . . . .	8-33
8.6	Editing a Component's Model . . . . .	8-38
8.6.1	Adding a Model to a Component . . . . .	8-40
8.6.1.1	Component List Dialog Box . . . . .	8-42
8.6.2	Creating a SPICE Model for a Component . . . . .	8-42
8.6.2.1	Creating a Model Using a Model Maker . . . . .	8-42
8.6.2.2	Creating a Primitive Model . . . . .	8-43
8.6.2.3	Creating a Subcircuit Model . . . . .	8-45
8.6.3	Loading an Existing Model . . . . .	8-48
8.6.4	Modify a Model's Data . . . . .	8-48
8.6.5	Copying the Model of One Component to Another . . . . .	8-49
8.7	Editing a Component Pin Model . . . . .	8-50
8.8	Editing a Component's Footprint . . . . .	8-51
8.8.1	Select a Footprint dialog box . . . . .	8-52
8.8.1.1	Filter dialog box . . . . .	8-53
8.8.2	Add a Footprint dialog box . . . . .	8-57
8.8.3	Advanced Pin Mapping Dialog . . . . .	8-58
8.9	Editing a Component's Electronic Parameters . . . . .	8-62
8.10	Editing User Fields . . . . .	8-63
8.11	Creating a Component Model Using the Model Makers . . . . .	8-64
8.11.1	AC Motor . . . . .	8-65
8.11.2	BJT Model Maker . . . . .	8-65
8.11.3	Converters . . . . .	8-77
8.11.3.1	Boost Converter . . . . .	8-78
8.11.3.2	Buck Boost Converter . . . . .	8-79
8.11.3.3	Buck Converter . . . . .	8-79
8.11.3.4	Cuk Converter . . . . .	8-80
8.11.4	Diode Model Maker . . . . .	8-80

---

8.11.5	Transformers	8-84
8.11.5.1	Ideal Transformer (Multiple Winding)	8-84
8.11.5.2	Linear Transformer (Multiple Winding)	8-85
8.11.5.3	Linear Transformer with Neutral Terminal	8-86
8.11.5.4	Two Winding Linear Transformer	8-87
8.11.5.5	Non-linear Transformer (Multiple Winding)	8-88
8.11.6	MOSFET (Field Effect Transistor) Model Maker	8-90
8.11.7	Operational Amplifier Model Maker	8-97
8.11.8	Silicon Controlled Rectifier Model Maker	8-102
8.11.9	Zener Model Maker	8-106
8.12	Creating a Model Using Code Modeling	8-111
8.12.1	What is Code Modeling?	8-111
8.12.2	Creating a Code Model	8-112
8.12.3	The Interface File (Ifspec.ifs)	8-115
8.12.3.1	Name Table	8-115
8.12.3.2	Port Table	8-117
8.12.3.3	Parameter Table	8-118
8.12.3.4	Example Interface File	8-120
8.12.4	The Implementation File (Cfunc.mod)	8-121
8.12.4.1	Implementation File C Macros	8-122
8.12.4.2	Example Implementation File	8-130

## 9. Simulation

9.1	Introduction to Simulation	9-2
9.2	Using Multisim Simulation	9-3
9.2.1	Start/Stop/Pause Simulation	9-4
9.2.1.1	Simulation Running Indicator	9-4
9.2.1.2	Simulation Speed	9-4
9.2.2	Circuit Consistency Check	9-5
9.2.3	Simulation from Netlist Without Schematic	9-6
9.3	Multisim SPICE Simulation: Technical Detail	9-6
9.3.1	Circuit Simulation Mechanism	9-6
9.3.2	Four Stages of Circuit Simulation	9-7
9.3.3	Equation Formulation	9-9
9.3.4	Equation Solution	9-10
9.3.5	User Setting: Maximum Integration Order	9-10

---

9.3.6	Convergence Assistance Algorithms	9-11
9.3.6.1	Gmin Stepping	9-11
9.3.6.2	Source Stepping	9-11
9.3.7	Digital Simulation	9-11
9.4	RF Simulation	9-12
9.5	MultiVHDL	9-13
9.6	Circuit Wizards	9-13
9.6.1	555 Timer Wizard	9-14
9.6.2	Filter Wizard	9-18
9.6.3	Common Emitter BJT Amplifier Wizard	9-19
9.6.4	MOSFET Amplifier Wizard	9-21
9.6.5	Opamp Wizard	9-22
9.7	Simulation Error Log/Audit Trail	9-25
9.8	Simulation Adviser	9-26
9.9	Saving/Loading Simulation Profiles	9-27
9.9.1	Saving a Simulation Profile	9-27
9.9.2	Loading a Simulation Profile	9-28
9.10	Using Simulation for Better Designs	9-28

## 10. Instruments

10.1	Introduction to the Multisim Instruments	10-3
10.1.1	Saving Simulation Data with Instruments	10-4
10.1.2	Adding an Instrument to a Circuit	10-5
10.1.3	Using the Instrument	10-5
10.1.4	Working with Multiple Instruments	10-6
10.1.5	Saving Instrument Data	10-7
10.2	Printing Instruments	10-7
10.2.1	Print Instruments Dialog	10-7
10.3	Interactive Simulation Settings	10-8
10.3.1	Troubleshooting Simulation Errors	10-9
10.4	Multimeter	10-10
10.4.1	Using the Multimeter	10-11
10.4.1.1	Multimeter Settings	10-11



---

10.5	Function Generator	10-14
10.5.1	Using the Function Generator	10-16
10.5.1.1	Function Generator Settings	10-16
10.6	Wattmeter	10-17
10.6.1	Using the Wattmeter	10-18
10.6.1.1	Connecting the Wattmeter	10-18
10.7	Oscilloscope	10-18
10.7.1	Using the Oscilloscope	10-20
10.7.1.1	Oscilloscope Settings	10-20
10.7.1.2	Viewing Oscilloscope Results	10-23
10.8	Bode Plotter	10-23
10.8.1	Using the Bode Plotter	10-25
10.8.1.1	Bode Plotter Settings	10-25
10.8.1.2	Viewing Bode Plotter Results	10-27
10.9	Word Generator	10-28
10.9.1	Using the Word Generator	10-29
10.9.1.1	Word Generator Settings	10-29
10.10	Logic Analyzer	10-31
10.10.1	Using the Logic Analyzer	10-33
10.10.1.1	Logic Analyzer Settings	10-33
10.11	Logic Converter	10-35
10.11.1	Using the Logic Converter	10-36
10.11.1.1	Logic Converter Settings	10-36
10.12	Distortion Analyzer	10-38
10.12.1	Using the Distortion Analyzer	10-39
10.12.1.1	Distortion Analyzer Settings	10-39
10.13	Spectrum Analyzer	10-40
10.14	Network Analyzer	10-40
10.15	Measurement Probe	10-40
10.15.1	Using the Measurement Probe	10-42
10.15.1.1	Measurement Probe Settings	10-42
10.15.1.2	Viewing Measurement Probe Results	10-44
10.15.1.3	Connecting the Measurement Probe	10-44

---

10.16	Four-channel Oscilloscope	10-47
10.16.1	Using the Four-channel Oscilloscope	10-48
10.16.1.1	Four-channel Oscilloscope Settings	10-48
10.16.1.2	Viewing Four-channel Oscilloscope Results	10-52
10.16.1.3	Connecting the Four-channel Oscilloscope	10-55
10.17	Frequency Counter	10-57
10.17.1	Using the Frequency Counter	10-57
10.18	IV Analyzer	10-60
10.18.1	Using the IV Analyzer	10-61
10.18.1.1	Simulate Parameters Dialog Box	10-63
10.18.2	Reviewing IV Analyzer Data	10-67
10.19	Agilent Simulated Instruments	10-70
10.19.1	Agilent Simulated Function Generator	10-71
10.19.1.1	Supported Features	10-71
10.19.1.2	Features Not Supported	10-72
10.19.1.3	Using the Agilent Function Generator	10-73
10.19.2	Agilent Simulated Multimeter	10-74
10.19.2.1	Supported Features	10-74
10.19.2.2	Features Not Supported	10-75
10.19.2.3	Using the Agilent Multimeter	10-76
10.19.3	Agilent Simulated Oscilloscope	10-77
10.19.3.1	Supported Features	10-77
10.19.3.2	Features Not Supported	10-80
10.19.3.3	Using the Agilent Oscilloscope	10-81
10.20	Tektronix Simulated Oscilloscope	10-82
10.20.1	Supported Features	10-82
10.20.2	Features Not Supported	10-84
10.20.3	Using the Tektronix Oscilloscope	10-84
10.21	Voltmeter	10-85
10.21.1	Using the Voltmeter	10-85
10.21.1.1	Resistance (1.0 W - 999.99 TW)	10-85
10.21.1.2	Mode (DC or AC)	10-86
10.21.1.3	Connecting a Voltmeter	10-86
10.22	Ammeter	10-86
10.22.1	Using the Ammeter	10-86
10.22.1.1	Resistance (1.0 pW - 999.99 W)	10-86
10.22.1.2	Mode (DC or AC)	10-87
10.22.1.3	Connecting an Ammeter	10-87

---

10.23	LabVIEW Instruments	10-87
10.23.1	System Requirements	10-88
10.23.2	Sample LabVIEW Instruments	10-88
10.23.2.1	Microphone	10-89
10.23.2.2	Speaker	10-89
10.23.2.3	Signal Generator	10-90
10.23.2.4	Signal Analyzer	10-90
10.23.3	Creating a LabVIEW Instrument	10-90
10.23.4	Building a LabVIEW Instrument	10-92
10.23.5	Installing a LabVIEW Instrument	10-93
10.23.6	Guidelines for Successfully Creating a LabVIEW Instrument	10-93

## 11. Analyses

11.1	Introduction to Multisim Analyses	11-4
11.2	Viewing the Analysis Results: Grapher	11-4
11.2.1	Working with Pages on the Grapher	11-7
11.2.2	Working with Graphs	11-8
11.2.2.1	Grids and Legends	11-9
11.2.2.2	Cursors	11-10
11.2.2.3	Cursor Pop-up Menu	11-11
11.2.2.4	Zoom and Restore	11-13
11.2.2.5	Title	11-14
11.2.2.6	Axes	11-15
11.2.2.7	Traces	11-16
11.2.2.8	Merging Traces	11-18
11.2.2.9	Select Pages dialog box	11-18
11.2.2.10	Graph Pop-up Menu	11-19
11.2.3	Viewing Charts	11-19
11.2.4	Cut, Copy and Paste	11-20
11.2.5	Opening and Saving Files	11-21
11.2.6	Print and Print Preview	11-22
11.3	Working with Analyses	11-23
11.3.1	General Instructions	11-23
11.3.2	The Analysis Parameters Tab	11-24
11.3.3	The Output Tab	11-24
11.3.3.1	Choosing How Output Variables are to be Handled	11-25
11.3.3.2	Filtering the Variable Lists	11-25
11.3.3.3	Adding Parameters to the Variable List	11-26
11.3.4	Adding Analysis Expressions	11-27

---

11.3.5	The Analysis Options Tab	11-29
11.3.6	The Summary Tab	11-30
11.3.7	Incomplete Analyses	11-30
11.4	DC Operating Point Analysis	11-31
11.4.1	About the DC Operating Point Analysis	11-31
11.4.2	Setting up and Running DC Operating Point Analysis	11-31
11.4.2.1	Setting DC Operating Point Analysis Parameters	11-32
11.4.3	Sample Circuit	11-32
11.4.4	Troubleshooting DC Operating Point Analysis Failures	11-33
11.4.4.1	Circuit failure example	11-33
11.4.4.2	Trouble-shooting Techniques	11-34
11.5	AC Analysis	11-35
11.5.1	About the AC Analysis	11-35
11.5.2	Setting AC Analysis Frequency Parameters	11-36
11.6	Transient Analysis	11-38
11.6.1	About the Transient Analysis	11-38
11.6.2	Setting Transient Analysis Parameters	11-38
11.6.3	Troubleshooting Transient Analysis Failures	11-40
11.7	Fourier Analysis	11-41
11.7.1	About the Fourier Analysis	11-41
11.7.2	Setting Fourier Analysis Parameters	11-42
11.8	Noise Analysis	11-44
11.8.1	About the Noise Analysis	11-44
11.8.2	Setting Noise Analysis Parameters	11-46
11.8.3	Noise Analysis Example	11-49
11.9	Distortion Analysis	11-51
11.9.1	Multisim Approach	11-52
11.9.2	Preparing the Circuit for Distortion Analysis	11-52
11.9.3	Understanding the Distortion Analysis Options	11-53
11.9.4	Distortion Analysis for Harmonic Distortion	11-54
11.9.5	Distortion Analysis for Intermodulation Distortion	11-56
11.10	DC Sweep Analysis	11-59
11.10.1	Setting DC Sweep Analysis Parameters	11-59
11.10.2	DC Sweep Analysis Examples	11-60

---

11.11 DC and AC Sensitivity Analyses . . . . .	11-65
11.11.1 Sensitivity Analysis Parameters . . . . .	11-65
11.11.2 Setting Up and Running Sensitivity Analysis . . . . .	11-66
11.11.2.1 Example 1 . . . . .	11-66
11.11.2.2 Example 2 . . . . .	11-70
11.12 Parameter Sweep Analysis . . . . .	11-71
11.12.1 About the Parameter Sweep Analysis . . . . .	11-71
11.12.2 Setting Parameter Sweep Analysis Parameters . . . . .	11-72
11.12.3 Parameter Sweep Analysis – Example . . . . .	11-74
11.13 Temperature Sweep Analysis . . . . .	11-80
11.13.1 About the Temperature Sweep Analysis . . . . .	11-80
11.13.2 Setting Temperature Sweep Analysis Parameters . . . . .	11-81
11.14 Transfer Function Analysis . . . . .	11-83
11.14.1 About the Transfer Function Analysis . . . . .	11-83
11.14.2 Setting Transfer Function Analysis Parameters . . . . .	11-84
11.14.3 Examples of Transfer Function Analysis . . . . .	11-85
11.14.3.1 Linear Example . . . . .	11-85
11.14.3.2 Non-linear Example . . . . .	11-87
11.15 Worst Case Analysis . . . . .	11-89
11.15.1 About the Worst Case Analysis . . . . .	11-89
11.15.1.1 Setting Tolerance Parameters . . . . .	11-90
11.15.2 Setting Worst Case Analysis Parameters . . . . .	11-92
11.15.3 Worst Case Analysis Example . . . . .	11-93
11.16 Pole Zero Analysis . . . . .	11-96
11.16.1 About the Pole Zero Analysis . . . . .	11-96
11.16.1.1 Multisim Approach . . . . .	11-99
11.16.2 Setting Pole Zero Analysis Parameters . . . . .	11-99
11.16.3 Running Pole Zero Analysis . . . . .	11-101
11.17 Monte Carlo Analysis . . . . .	11-103
11.17.1 About the Monte Carlo Analysis . . . . .	11-103
11.17.1.1 Uniform Distribution . . . . .	11-103
11.17.1.2 Gaussian Distribution . . . . .	11-104
11.17.2 Setting Up and Running Monte Carlo Analysis . . . . .	11-106
11.17.2.1 Entering a Component Tolerance . . . . .	11-106
11.17.2.2 Specifying Monte Carlo Analysis Parameters . . . . .	11-107
11.17.3 Monte Carlo Analysis Example . . . . .	11-108
11.17.3.1 Setting up the Sample Monte Carlo Analysis . . . . .	11-109
11.17.3.2 Simulation Results . . . . .	11-111

---

11.18	Trace Width Analysis	11-115
11.18.1	Multisim Approach	11-116
11.18.2	Sample Trace Width Analysis	11-118
11.19	RF Analyses	11-121
11.20	Nested Sweep Analyses	11-121
11.21	Batched Analyses	11-123
11.22	User Defined Analyses	11-124
11.22.1	About the User Defined Analysis	11-124
11.22.2	Creating and Simulating a SPICE Netlist	11-125
11.22.3	Importing the SPICE netlist into Multisim	11-126
11.22.4	Plotting Two Nodes Using the Tran Statement	11-127
11.22.5	How to Run an AC Analysis	11-128
11.23	Analysis Options dialog box.	11-129
11.23.1	Global tab	11-130
11.23.2	DC tab	11-132
11.23.3	Transient tab	11-133
11.23.4	Device tab	11-134
11.23.5	Advanced tab	11-135

## 12. Postprocessor

12.1	Introduction to the Postprocessor	12-2
12.2	Using the Postprocessor	12-2
12.2.1	Basic Steps	12-2
12.2.1.1	Using the Default Analysis	12-7
12.2.1.2	Creating Multiple Traces	12-8
12.2.2	Working with Pages, Traces, Graphs and Charts	12-8
12.3	Postprocessor Variables	12-9
12.4	Available Postprocessor Functions	12-10

---

## 13. Reports

13.1	Bill of Materials	13-2
13.1.1	Using the BOM Report	13-3
13.2	Component Detail Report	13-5
13.2.1	Using the Component Detail Report	13-5
13.3	Netlist Report	13-6
13.3.1	Using the Netlist Report	13-7
13.4	Schematic Statistics Report	13-8
13.4.1	Using the Schematic Statistics Report	13-8
13.5	Spare Gates Report	13-9
13.5.1	Using the Spare Gates Report	13-10
13.6	Model Data Report	13-11
13.6.1	Using the Model Data Report	13-11
13.7	Cross Reference Report	13-12
13.7.1	Using the Cross Reference Report	13-12
13.8	Variants Filter Dialog Box	13-13

## 14. Transfer/Communication

14.1	Introduction to Transfer/Communication	14-2
14.2	Exporting to PCB layout	14-2
14.2.1	Transferring from Multisim to Ultiboard for PCB Layout	14-3
14.2.2	Transferring to Other PCB Layout Packages	14-4
14.2.3	Multisection Components	14-4
14.3	Forward Annotation	14-4
14.4	Back Annotation	14-5
14.5	Exporting Simulation Results	14-5
14.5.1	Exporting to MathCAD	14-5
14.5.2	Exporting to Excel	14-6
14.5.3	Exporting to LabView	14-7
14.6	Exporting a Netlist	14-7
14.7	Importing Files with Other Formats	14-8
14.7.1	Importing a SPICE or PSPICE Netlist	14-9
14.8	Internet Design Sharing	14-10

---

## 15. RF

15.1	Introduction to the Multisim RF Module	15-2
15.2	Components	15-2
15.2.1	About RF Components	15-2
15.2.2	Multisim's RF Components	15-3
15.2.3	Theoretical Explanation of the RF Models	15-4
15.2.3.1	Striplines/Microstrips/Waveguides	15-4
15.2.3.2	RF Resistors	15-6
15.2.3.3	RF Capacitors	15-6
15.2.3.4	RF Inductors	15-7
15.2.3.5	Active Devices	15-7
15.3	RF Instruments	15-9
15.3.1	Spectrum Analyzer	15-9
15.3.1.1	About the Spectrum Analyzer	15-9
15.3.1.2	Using Multisim's Spectrum Analyzer	15-9
15.3.1.3	Frequency Range	15-10
15.3.1.4	Frequency Spans	15-10
15.3.1.5	Frequency Analysis	15-11
15.3.1.6	Amplitude Range	15-12
15.3.1.7	Reference Level	15-12
15.3.1.8	Frequency Resolution	15-13
15.3.1.9	Examples	15-13
15.3.2	Network Analyzer	15-15
15.3.2.1	About the Network Analyzer	15-15
15.3.2.2	Using the Network Analyzer	15-16
15.3.2.3	Marker Controls	15-17
15.3.2.4	Trace Controls	15-17
15.3.2.5	Format Controls	15-17
15.3.2.6	Data Controls	15-18
15.3.2.7	Mode Controls	15-18
15.4	RF Analyses	15-18
15.4.1	RF Characterizer Analysis	15-18
15.4.2	Matching Network Analysis	15-20
15.4.3	Noise Figure Analysis	15-25
15.4.3.1	Multisim Approach	15-27
15.4.3.2	Noise Figure Analysis Tabs	15-28
15.4.3.3	Sample Noise Figure Analysis	15-29



---

15.5	RF Model Makers .....	15-31
15.5.1	Waveguide .....	15-31
15.5.2	Microstrip Line .....	15-32
15.5.3	Open End Microstrip Line .....	15-33
15.5.4	RF Spiral Inductor .....	15-34
15.5.5	Strip Line Model .....	15-35
15.5.6	Stripline Bend .....	15-36
15.5.7	Lossy Line .....	15-37
15.5.8	Interdigital Capacitor .....	15-38
15.6	Tutorial: Designing RF Circuits .....	15-39
15.6.1	Selecting Type of RF Amplifier .....	15-40
15.6.2	Selecting an RF Transistor .....	15-40
15.6.3	Selecting a DC-operating Point .....	15-41
15.6.4	Selecting the Biasing Network .....	15-41
	15.6.4.1 Selecting an Operating Frequency Point .....	15-43
	15.6.4.2 Analyzing the RF Network .....	15-43

## Appendix A

A.1	Multisim Menus .....	A-1
A.1.1	File Menu .....	A-1
A.1.1.1	File/New/Schematic Capture .....	A-1
A.1.1.2	File/Open .....	A-2
A.1.1.3	File/Open Samples .....	A-2
A.1.1.4	File/Close .....	A-2
A.1.1.5	File/Close All .....	A-2
A.1.1.6	File/Save .....	A-2
A.1.1.7	File/Save As .....	A-2
A.1.1.8	File/Save All .....	A-2
A.1.1.9	File/New Project .....	A-3
A.1.1.10	File/Open Project .....	A-3
A.1.1.11	File/Save Project .....	A-3
A.1.1.12	File/Close Project .....	A-3
A.1.1.13	File/Version Control .....	A-3
A.1.1.14	File/Print .....	A-3
A.1.1.15	File/Print Preview .....	A-3
A.1.1.16	File/Print Options/Printer Setup .....	A-3
A.1.1.17	File/Print Options/Print Circuit Setup .....	A-3
A.1.1.18	File/Print Options/Print Instruments .....	A-4
A.1.1.19	File/Recent Circuits .....	A-4
A.1.1.20	File/Recent Projects .....	A-4
A.1.1.21	File/Exit .....	A-4

---

A.1.2	Edit Menu	A-4
A.1.2.1	Edit/Undo	A-4
A.1.2.2	Edit/Redo	A-4
A.1.2.3	Edit/Cut	A-4
A.1.2.4	Edit/Copy	A-5
A.1.2.5	Edit/Paste	A-5
A.1.2.6	Edit/Delete	A-5
A.1.2.7	Edit/Select All	A-5
A.1.2.8	Edit/Delete Multi-Page	A-5
A.1.2.9	Edit/Paste as Subcircuit	A-5
A.1.2.10	Edit/Find	A-6
A.1.2.11	Edit/Graphic Annotation	A-6
A.1.2.12	Edit/Order	A-6
A.1.2.13	Edit/Assign to Layer	A-6
A.1.2.14	Edit/Layer Settings	A-6
A.1.2.15	Edit/Title Block Position	A-7
A.1.2.16	Edit/Orientation	A-7
A.1.2.17	Edit/Symbol/Title Block	A-7
A.1.2.18	Edit/Font	A-8
A.1.2.19	Edit/Comment	A-8
A.1.2.20	Edit/Forms	A-8
A.1.2.21	Edit/Properties	A-8
A.1.3	View Menu	A-8
A.1.3.1	View/Full Screen	A-8
A.1.3.2	View/Parent Sheet	A-8
A.1.3.3	View/Zoom In	A-8
A.1.3.4	View/Zoom Out	A-8
A.1.3.5	View/Zoom Area	A-9
A.1.3.6	View/Zoom Fit to Page	A-9
A.1.3.7	View/ Show Grid	A-9
A.1.3.8	View/Show Border	A-9
A.1.3.9	View/Show Page Bounds	A-9
A.1.3.10	View/Ruler Bars	A-9
A.1.3.11	View/Status Bar	A-9
A.1.3.12	View/Design Toolbox	A-9
A.1.3.13	View/Spreadsheet View	A-9
A.1.3.14	View/Circuit Description Box	A-9
A.1.3.15	View/Toolbars	A-10
A.1.3.16	View/Comment/Probe	A-11
A.1.3.17	View/Grapher	A-11

---

A.1.4	Place Menu	A-12
A.1.4.1	Place/Component	A-12
A.1.4.2	Place/Junction	A-12
A.1.4.3	Place/Wire	A-12
A.1.4.4	Place/Bus	A-12
A.1.4.5	Place/Connectors	A-12
A.1.4.6	Place/Hierarchical Block from File	A-13
A.1.4.7	Place/New Hierarchical Block	A-13
A.1.4.8	Place/Replace by Hierarchical Block	A-13
A.1.4.9	Place/New Subcircuit	A-13
A.1.4.10	Place/Replace by Subcircuit	A-13
A.1.4.11	Place/Multi-Page	A-13
A.1.4.12	Place/Merge Bus	A-13
A.1.4.13	Place/Bus Vector Connect	A-13
A.1.4.14	Place/Comment	A-14
A.1.4.15	Place/Text	A-14
A.1.4.16	Place/Graphics	A-14
A.1.4.17	Place/Title Block	A-15
A.1.5	Simulate Menu	A-15
A.1.5.1	Simulate/Run	A-15
A.1.5.2	Simulate/Pause	A-15
A.1.5.3	Simulate/Instruments	A-15
A.1.5.4	Simulate/Interactive Simulation Settings	A-18
A.1.5.5	Simulate/Digital Simulation Settings	A-18
A.1.5.6	Simulate/Analyses	A-18
A.1.5.7	Simulate/Postprocessor	A-21
A.1.5.8	Simulate/Simulation Error Log/Audit Trail	A-21
A.1.5.9	Simulate/XSpice Command Line Interface	A-21
A.1.5.10	Simulate/Load Simulation Settings	A-21
A.1.5.11	Simulate/Save Simulation Settings	A-21
A.1.5.12	Simulate/VHDL Simulation	A-21
A.1.5.13	Simulate/Probe Properties	A-21
A.1.5.14	Simulate/Reverse Probe Direction	A-22
A.1.5.15	Simulate/Clear Instrument Data	A-22
A.1.5.16	Simulate/Global Component Tolerances	A-22
A.1.6	Transfer Menu	A-22
A.1.6.1	Transfer/Transfer to Ultiboard	A-22
A.1.6.2	Transfer/Transfer to Other PCB Layout	A-22
A.1.6.3	Transfer/Forward Annotate to Ultiboard	A-22
A.1.6.4	Transfer/Backannotate from Ultiboard	A-22
A.1.6.5	Transfer/Highlight Selection in Ultiboard	A-23
A.1.6.6	Transfer/Export Netlist	A-23

---

A.1.7	Tools Menu	A-23
A.1.7.1	Tools/Component Wizard	A-23
A.1.7.2	Tools/Database	A-23
A.1.7.3	Tools/Circuit Wizards/555 Timer Wizard	A-24
A.1.7.4	Tools/Circuit Wizards/Filter Wizard	A-24
A.1.7.5	Tools/Circuit Wizards/Opamp Wizard	A-24
A.1.7.6	Tools/Circuit Wizards/CE BJT Amplifier Wizard	A-24
A.1.7.7	Tools/Circuit Wizards/MOSFET Amplifier Wizard	A-24
A.1.7.8	Tools/Variant Manager	A-24
A.1.7.9	Tools/Set Active Variant	A-24
A.1.7.10	Tools/Rename/Renumber Components	A-24
A.1.7.11	Tools/Replace Component	A-25
A.1.7.12	Tools/Update Circuit Components	A-25
A.1.7.13	Tools/Electrical Rules Check	A-25
A.1.7.14	Tools/Clear ERC Markers	A-25
A.1.7.15	Tools/Toggle NC Marker	A-25
A.1.7.16	Tools/Symbol Editor	A-25
A.1.7.17	Tools/Title Block Editor	A-25
A.1.7.18	Tools/Description Box Editor	A-25
A.1.7.19	Tools/Edit Labels	A-26
A.1.7.20	Tools/Capture Screen Area	A-26
A.1.7.21	Tools/Internet Design Sharing	A-26
A.1.8	Reports Menu	A-26
A.1.8.1	Reports/Bill of Materials	A-26
A.1.8.2	Reports/Component Detail Report	A-26
A.1.8.3	Reports/Netlist Report	A-26
A.1.8.4	Reports/Cross Reference Report	A-26
A.1.8.5	Reports/Schematic Statistics	A-27
A.1.8.6	Reports/Spare Gates Report	A-27
A.1.9	Options Menu	A-27
A.1.9.1	Options/Global Preferences	A-27
A.1.9.2	Options/Sheet Properties	A-27
A.1.9.3	Options/Customize User Interface	A-27
A.1.10	Window Menu	A-27
A.1.10.1	Window/New Window	A-27
A.1.10.2	Window/Cascade	A-27
A.1.10.3	Window/Tile Horizontal	A-28
A.1.10.4	Window/Tile Vertical	A-28
A.1.10.5	Window/Close All	A-28
A.1.10.6	Window/Windows	A-28
A.1.10.7	Window (open files)	A-28

---

A.1.11	Help Menu	A-28
A.1.11.1	Help/Multisim Help	A-28
A.1.11.2	Help/Component Reference	A-28
A.1.11.3	Help/Release Notes	A-29
A.1.11.4	Help/Check for Updates	A-29
A.1.11.5	Help/File Information	A-29
A.1.11.6	Help/About Multisim	A-29

# Chapter 1

## Installing Multisim



This chapter contains Multisim installation instructions. It also includes documentation on the **Support and Upgrade Utility (SUU)** and the **Network License Server (NLS)**.

Some of the features described in this chapter may not be available in your edition of Multisim 9. Such features have an icon in the column next to their description. Refer to the release notes for a list of the features in your edition.

The following are described in this chapter.

<b>Subject</b>	<b>Page No.</b>
<b>Installation Requirements</b>	1-2
<b>Installation Overview</b>	1-3
<b>Installing Multisim 9</b>	1-3
Before Installing Multisim 9	1-3
Single User Edition	1-4
Multi-Station Standalone Edition	1-5
Network Version	1-5
Changing Server Name and/or Port Number After Client Installation	1-10
<b>Network License Server</b>	1-10
Administering the Network License Server	1-10
Administering Fixed Seat Licenses	1-11
Reviewing License Server Events	1-12
Troubleshooting	1-12
<b>Support and Upgrade</b>	1-14
Checking for Updates	1-14
Installing Updates	1-14
Viewing Messages	1-15
Changing Settings	1-15
<b>Uninstalling Multisim 9</b>	1-16
Uninstalling the Single User Version	1-16

<b>Subject</b>	<b>Page No.</b>
<b>Uninstalling SUU</b>	1-16
<b>Uninstalling a Site Version</b>	1-17
Uninstalling Standalone Multi-Station Installation	1-17
Uninstalling Network Installation	1-17
Uninstalling Combination Standalone Multi-Station and Network Installations	1-17
<b>Uninstalling NLS</b>	1-18

# 1.1 Installation Requirements

To successfully install Multisim 9, you may need up to 150 MB of hard disk space, depending on which edition you have purchased. Your system also requires the following:

### Minimum System Requirements

Windows 2000/XP  
Pentium III Processor  
128 MB RAM  
CD-ROM  
800 x 600 screen resolution

### Recommended System Requirements

Windows XP Professional  
Pentium 4 Processor  
256 MB RAM  
CD-ROM  
1024 x 768

## 1.2 Installation Overview

Multisim 9 has three types of installation: Single User Edition, Network Edition, and Multi-Station Standalone Edition.

**Single User Edition** – The Single User Edition is only licensed on the computer on which you install it. If for any reason you wish to move the software to a different computer, you must first uninstall it from the initial computer, and then re-install it onto the new computer. In this case, you must contact Electronics Workbench to receive a new Release Code.

For details on the installation process see “1.3.2.1 Installing the Single User Edition” on page 1-4”.

**Network Edition** – Either fixed or floating licenses are available from Electronics Workbench for the Network Edition.

A floating license allows any computer to run Multisim 9 on a first-come, first-served basis. Maximum concurrent uses are limited to the number of seats you have purchased. A fixed license allows only a set number of specific computers to run the software. You may select and change the specific computers allowed access using the NLS Utility, up to the number of fixed licenses you have purchased (see “1.4.2 Administering Fixed Seat Licenses” on page 1-11).

See also, “1.3.4 Network Version” on page 1-5.

**Multi-Station Standalone Edition** – If you are installing Multisim 9 on various computers in a non-networked environment, then you are installing a Multi-Station Standalone Edition. This type of installation is identical to that of the Single User Edition, except that you may install a single copy of Multisim 9 per computer on as many computers as specified by the License Agreement. For details on the installation process see “1.3.2.1 Installing the Single User Edition” on page 1-4.

## 1.3 Installing Multisim 9

### 1.3.1 Before Installing Multisim 9

If you are upgrading to Multisim 9 from a previous version and wish to import your corporate or user database, you will first need to make a back-up copy of the database.

➤ To back-up your database:

1. Browse to the directory location where you have your previous version of Multisim (for example, C:\Program Files\Electronics Workbench\EWB8.



2. Copy the entire \database folder to a location that you will remember later (for example, C:\Temp).
3. Your database is now safely backed-up.

**Note** You will require Administrator privileges to install Electronics Workbench software and to enter release codes.

### 1.3.2 Single User Edition

You have been provided with a serial number that you will be required to enter at the time of installation. The Single User Edition is only licensed on the computer on which you install it. If for any reason you wish to move the software to a different computer, you must first uninstall it from the initial computer, and then re-install it onto the new computer. In this case, you must contact Electronics Workbench to receive a new Release Code.

#### 1.3.2.1 Installing the Single User Edition

The Multisim 9 CD you received will autostart when inserted in the CD-ROM drive. Follow the instructions below and on the screen during the installation process.

- To install Multisim 9:
  1. Copy down the serial number you have received with your Multisim 9 package.
  2. Exit all Windows applications prior to continuing with the installation.
  3. Insert the Multisim 9 CD into your CD-ROM drive. When the splash screen appears, click on Multisim 9 to begin the installation.
  4. Follow the on-screen prompts to complete the installation.

#### 1.3.2.2 Requesting a Release Code for the Single User Version

Multisim 9 requires you to enter a Release Code within five days of the date of installation. After the five day grace period has expired, Multisim 9 will not run until a Release Code is entered.

To obtain your Release Code, you must provide us with the Serial Number and Signature, as shown on the splash screen that displays when you launch Multisim. Contact Electronics Workbench via our website (preferred method) at [www.electronicsworkbench.com](http://www.electronicsworkbench.com) and select the Product Registration link, or call Customer Service at 1.800.263.5552. Customers outside North America should contact their local distributor.

Electronics Workbench recommends that you obtain your Release Code as soon as possible after you have installed Multisim 9.

➤ To enter the Release Code:

1. Click on the **Enter Release Code** button at the start-up splash screen.
2. If you have received your Release Code via email there are a few ways to easily enter it without the need to type each number or character one at a time. Select one of the following methods:
  - Highlight the Release Code. Drag and drop it on one of the text boxes.
  - Highlight the Release Code, right-click on it and select Copy. Click on the **Paste Release Code** button.
  - Highlight the Release Code, right-click on it and select Copy. Right-click on one of the text boxes and click on Paste from the pop-up menu.
3. If you have received your Release Code over the phone, you must type it in the Release Code fields 5 characters at a time.
4. Click **Accept** to continue.

### 1.3.3 Multi-Station Standalone Edition

If you purchased the Multi-Station Standalone edition, you have been provided with one serial number that you will use for each computer. You must then go to each computer on which Multisim is installed, and separately request a Release Code for each, which enables the software on that computer. Because of this inconvenience, and because of the fact that the software is tied to particular computers, the Network Edition is the preferred alternative in networked settings.

The Multi-Station Standalone Edition and Single User Edition installations are identical except that you will re-use the same serial number multiple times.

### 1.3.4 Network Version

For network versions, the client software (Multisim 9) may be installed:

1. On a central file server that serves the software to other networked computers (called "workstations").
2. Locally on each workstation computer. This option gives the best performance, as the software need not be accessed across a network. However, it takes up the most disk space on the workstation computers and requires updates to be installed separately on each workstation. This option can be combined with option 1, where some workstations may

have the client software installed locally, and other workstations may have the software served from a shared file system.

3. On several file servers, each one of which serves the software to a subset of the networked computers, and, optionally, also on selected workstation computers. This option is intermediate between options 1 and 2.

If options 1 or 3 are selected, the network must be set up to allow access from the workstations to the shared file systems on which the client software is installed. For all of the options above (1, 2 or 3), you must also install the Electronics Workbench Network License Server (NLS) on any one computer on the network. This computer does not need to share a file system with the client software. However, it requires TCP/IP access from the workstation computers. This computer will run a Windows service that keeps track of and limits the number of licenses currently in use. From that computer, administrators may run the NLS utility that shows information on licenses available, the users currently utilizing the licenses, and enables users to be remotely logged off.

As with the single user edition, you have been provided with a serial number that you will require during each installation of Multisim 9 and for the lone installation of NLS. The serial number identifies the product as being a Network Edition. Using NLS, you may access the hardware signature of the NLS server computer. You must send the NLS server's hardware signature and your serial number to Electronics Workbench. You will receive a Release Code that you will need to enter into NLS to enable the network edition to function. The Release Code encodes the number of seats and any term limits on your license.

A Multisim workstation will access either a fixed or a floating license depending upon the serial number entered at the time of install of the Multisim 9 client software that the workstation uses. In either the fixed or the floating case, the Multisim 9 client software may be installed either directly on the workstation computer, or onto a shared file server. Different serial numbers are provided to you for each of these cases.

**Note** NLS is only licensed on the computer on which you install it. If for any reason you wish to move the NLS service to a different computer, you must first uninstall it from the initial computer, and then re-install it onto the new computer. In this case, you must contact Electronics Workbench to receive a new Release Code.

### 1.3.4.1 Installing the Network Edition

The Multisim 9 CD you received will autostart when inserted in the CD-ROM drive. Follow the instructions below and on the screen during the installation process.

- To install Multisim 9:
  1. Copy the serial number you have received with your Multisim 9 package.
  2. Exit all Windows applications prior to continuing with the installation.

3. Insert the Multisim 9 CD into your CD-ROM drive. When the splashscreen appears, click on Multisim 9 to begin the installation.
4. Follow the on-screen prompts to complete the installation.

### 1.3.4.2 Entering the Release Code for the Network Edition

After installing NLS, you will be required to enter a Release Code to enable the workstations to run Multisim 9. (NLS is installed at the same time as the Multisim 9 Network Edition).

To perform this step, you will need to use the NLS Utility that you have previously installed on your license server. See “1.4 Network License Server” on page 1-10 for further information.

**Note** To obtain the Release Code, contact Electronics Workbench via our website (preferred method) at [www.electronicsworkbench.com](http://www.electronicsworkbench.com) and select the Product Registration link, or call Customer Service at 1.800.263.5552. Customers outside North America should contact their local distributor.

### 1.3.4.3 Workstation Setup

If for your Network Installation you choose to serve Multisim 9 from a file server to the workstation computers, you will need to perform an extra setup step on each workstation computer as follows.

1. Log on to each workstation with administrator privileges.
2. Using Windows Explorer, navigate to the <install-root>\EWB9\Setup folder on the computer drive where Multisim 9 was installed on the network.
3. Double-click on setup.exe to install the shortcuts to the software on the computer. The setup routine will configure the workstation.

Access to Multisim 9 directories should be restricted by placing certain user permissions on various directories. Follow the instructions below to place the appropriate permissions.

### 1.3.4.4 Setting User Permissions

If you are installing the Multisim 9 Network Edition, you will need to set certain restrictions on the folder where Multisim is installed in order to prevent non-administrative users from modifying, writing or deleting program files that otherwise would make the software unusable.

Note that there are many different ways to set permissions in a networked environment. The following settings are one way of configuring a Windows XP Professional-based computer that is not part of a network domain (i.e., using workgroup sharing). It is recommended that

you have advanced knowledge of NTFS and share permissions. Contact your administrator for help.

### **Multisim 9 Permissions on a Windows XP Professional-based Computer**

1. Browse to <install-root>\EWB9, where the Multisim 9 Network Edition is installed on the server.
2. Right-click on the \EWB9 folder and click on “**Sharing and Security**” from the pop-up menu.
3. Click on the “**Sharing**” tab on the EWB9 Properties dialog and select “Share this folder”.
4. Click on the “**Permissions**” button. The “Permissions for EWB9” dialog will pop-up.
5. Under “Groups or user names”, select the security group that requires access to Multisim 9. (If everybody on the network is allowed access, select “Everyone”).
6. Set the following permissions:

<b>Permission</b>	<b>Allow</b>	<b>Deny</b>
Full Control	X	
Change	X	
Read	X	

All other options shown on the dialog should be unchecked unless specified on the above table. Click **OK** to accept the permissions.

7. Click on the **Security** tab and select the appropriate group under “Group or user names”.
8. Click on the “**Advanced**” button. The “Advanced Security Settings for EWB9” dialog will pop-up.
9. On the **Permissions** tab, click on the “Edit” button. The “Permissions Entry for EWB9” dialog will pop-up.

10. Set the following permissions:

Permission	Allow	Deny
Read & Execute	X	
List Folder Contents	X	
Read	X	

All other options shown on the dialog should be unchecked unless specified on the above table.

Under the “Advanced” tab, make sure that the option “**Inherit from parent the permission entries that apply to child objects. Include these with entries explicitly defined here**” is unchecked.

Place a check mark on “**Replace permission entries on all child objects with entries shown here that apply to child objects**”. Click **OK** to accept the permissions.

11. Click **OK** on the “EWB9 Properties” dialog. You have now set up the EWB9 folder directory and all sub-directories and files with “Read & Execute” permissions.

Certain files and sub folders need to also be given “Write” permissions for Multisim 9 to function properly on a networked environment.

Please follow the instructions below:

1. Browse to <install-root>\EWB9\database folder.
2. Right-click on the \EWB9\database folder and click on “**Sharing and Security**” from the pop-up menu.
3. Click on the **Security** tab and select the appropriate group under “Group or user names”.
4. Under “Permissions” add a check mark for “Modify” and “Write” under the “Allow” column. Click **OK** to accept the permissions on that folder.
5. Repeat Step 2-4 for the “**Multisim users**” and “**Ultiboard users**” folder.

## 1.3.5 Changing Server Name and/or Port Number After Client Installation

If after having installed Multisim 9 on workstations and/or file servers it becomes necessary to change the server name or port number, it is possible to do this without re-installing the client software. On each Multisim 9 installation, navigate to the Settings sub-directory (by default located in 'C:\Program Files\Electronics Workbench\EWB9\Settings') and use a text editor (such as Notepad) to edit the file **Multisim.ini**. Change the entries next to Port and Server.

## 1.4 Network License Server

The **Network License Server** (NLS) is used to administer network installations. If you have installed a network version of any Electronics Workbench software, the **Network License Server** will automatically run in the background whenever the computer on which it is installed is operating.

### 1.4.1 Administering the Network License Server

- To administer the **Network License Server**:

1. Click Start > All Programs > Electronics Workbench > Network License Server > Network License Server.

*Or*

Double-click on the short-cut icon that was placed on your desktop during installation.

2. Click **New** to add a product. The **Add Product** dialog box appears.
3. Enter a valid serial number and click **OK**.

**Tip** If you have the serial number recorded electronically (for instance, in an email), you can drag-and-drop it into the field in the **Add Product** dialog box.

4. Right-click on the Release Code line and select Edit Release Code from the pop-up.
5. You can either copy the release code and click **Paste Release Code**, drag-and-drop the release code into any of the **Release Code** fields, or type it in manually.

**Note** For instructions on obtaining the release code, see “1.3.4.2 Entering the Release Code for the Network Edition” on page 1-7.

6. Click **Save** to return to the main dialog box. The release code has been added to the Release Code line.

7. When network seats are being used, the dialog will appear similar to the following:

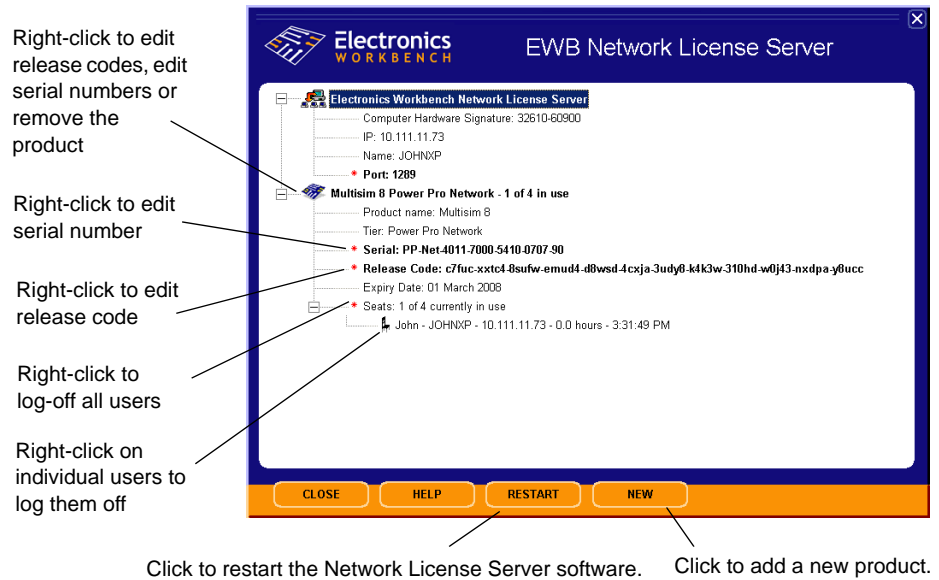

## 1.4.2 Administering Fixed Seat Licenses

This section gives additional information needed for the administration of Fixed Seat Licenses.

- To add (authorize) a seat signature:
  1. Go to the computer that contains the client software that you wish to add (for example, Multisim) and launch the software. As this software is not yet authorized, a message displays indicating that the computer's signature was not recognized by the server. Copy down the signature indicated in the message.
  2. From NLS, right-click on **Authorized Seat Signatures** and select **Authorize a new computer** from the pop-up that displays.
  3. When prompted, enter the signature that you copied down from the client computer and click **OK**.



## Authorized and Available Seats

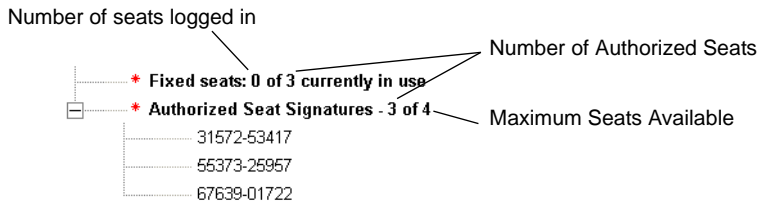

### 1.4.3 Reviewing License Server Events

The **Network License Server** records all client connections or attempted connections in the system event log. To access the event log, go to the **Windows Control Panel**, select **Administrative Tools**, and then select **Event Viewer**.

In the left-hand pane of the **Event Viewer**, choose **Application Log**. All events with the source **EWBNLSS** are from the **Network License Server**. Double-click on any event to see more detail.

### 1.4.4 Troubleshooting

The following contains solutions to situations that may be encountered with the **Network License Server**.

- **Network License Server gives “Permission Denied” message.**  
For security reasons, the **Network License Server** may only be run from an account with administrator privileges. Attempting to control the license server from a “user” or “power user” account will cause a permission denied error.
- **Client application gives “Connection to the license server failed” message.**  
Make sure that the server address and port number on the client **Network License Server** dialog have been set correctly. If you have entered a machine name as the server address, try using the numeric IP address instead. In some networks, this IP address may change dynamically. Please contact your network administrator for assistance if this occurs frequently.

If either the server machine or client machine has a firewall installed (including the Windows XP service pack 2 internal firewall), make sure that either:

- a) the required port is allowed to be open (in TCP protocol) or
- b) the server program (EWBNLSS) or client application is granted an exception.

Please see your firewall's documentation for more information.

- **Client application gives “This product is not registered on the license server” message.**

Make sure that you have used the same product serial number on both the client and the server.

Make sure that the registration code has been accepted by the license server. No client application will be licensed until the product has been successfully registered.

- **Client application gives “No more instances of the program can be run on the network” message.**

This message is returned when all available license seats have been used up. When a user shuts down the client application normally, their seat should be released immediately; however, when a client application terminates unexpectedly (the computer is turned off while running or there is a fatal error), the license server may take up to five minutes to relinquish this license for reuse. If you believe that there should be seats available and clients are being denied licenses, waiting for five minutes to log on is usually sufficient to allow these seats to be freed.

The administrator may also wish to check the **Network License Server** control screen and try to identify unused but unreleased licenses by their computer name or IP address subdomain. If the administrator logs off these users, their licenses will be immediately available for new clients. The administrator may also check for users running multiple clients on a single machine.

In extreme cases, the administrator may click the **Restart** button on the **Network License Server**. This will immediately release all licenses and then reissue them silently to active authorized users only. For most client users, this will be an invisible process. This option should however be used with caution: if the number of clients requesting licenses is indeed over the seat limit, the license server cannot guarantee that exactly the same set of clients will be granted licenses as had them before the reset operation. Therefore, some authorized clients may be given the “no more instances of the program can be run on the network” message in the middle of their active session and be prohibited from continuing their work (however, they will be given the opportunity to save their work).

## 1.5 Support and Upgrade

The Support and Upgrade program lets you call Electronics Workbench with your technical questions. The program also entitles you to no-charge upgrades to the software as new versions are released.

Between major upgrade releases, Electronics Workbench puts out a series of patches that may add incremental functionality, add new parts to the database, or quickly address any issues found in the field.

If you allow it to (a choice you initially make upon install and can later change), Multisim or Ultiboard will quickly and silently check the Electronics Workbench website for the availability of new patches and upgrades when you start the application. If any are available, it will open the Support and Upgrade Utility (SUU) program that will allow you to download and install all the necessary patches to get you to the most current version of your product.

### 1.5.1 Checking for Updates

Unless you selected **I will check for updates and messages manually** during the installation of your software (e.g., Multisim, Ultiboard), SUU checks for updates when you launch that software. You can also check for updates at any time by following the procedure below.

➤ To check for updates:

1. Select **Help/Check for Updates**. SUU launches and checks for updates.
2. If updates are available, it is indicated in the **Support and Upgrade Utility** window. You can click on the **Release Notes** link for a description of the upgrade.

**Note** A message advising that your software is up-to-date appears if there are no updates available.

3. Proceed to “1.5.2 Installing Updates” on page 1-14.

### 1.5.2 Installing Updates

Use the procedure below to install updates. To determine if updates are available, see “1.5.1 Checking for Updates” on page 1-14.

Most users will install all available upgrades. You can also upgrade to a specific version. This option should only be used to ensure parallel versions of software are being run within an organization or institution.

## Installing all Updates

- To install all available updates:
  1. From the **Support and Upgrade Utility**, click on **Upgrade to Latest Version**.  
Patch information appears as the download progresses. When all downloads have been made the install process begins.
  2. Follow the onscreen prompts (if available) to complete the upgrade.

**Note** Some patches may be configured to install without user input.

## Upgrading to a Specific Version

- To upgrade to a specific version:
  1. From the **Support and Upgrade Utility**, click on **Advanced Options**.
  2. Click on a button in the **Upgrade to Specific Version** column.
  3. Click **Yes** when prompted to confirm the upgrade.  
Patch information appears as the download progresses. When all downloads have been made the install process begins.
  4. Follow the onscreen prompts to complete the upgrade.

## 1.5.3 Viewing Messages

- To view messages:
  1. Select **Help/Check for Updates**. SUU launches and checks for updates.  
(For instructions on what to do if there are available updates, see “1.5.2 Installing Updates” on page 1-14).
  2. Click on **more info...** in the **Messages** area, beside the message of interest. The full message appears.
  3. You can also click on **Message History** to display a history of received messages.

## 1.5.4 Changing Settings

The initial settings for SUU are done during Multisim’s installation procedure. If you would like to change these settings, follow the procedure outlined below.

- To change the Support and Upgrade Utility’s settings:
  1. Select **Help/Check for Updates**. SUU launches and checks for updates.

(For instructions on what to do if there are available updates, see “1.5.1 Checking for Updates” on page 1-14).

2. Click on the **Settings** button.

**Note** The **Language** field applies to messages only. The software’s language is not affected by this setting.

3. Select the desired options and click **OK**.

## 1.6 Uninstalling Multisim 9

### 1.6.1 Uninstalling the Single User Version

1. Ensure that you have recorded the serial number before uninstalling the software.
2. Click the Windows **Start** button.
3. Click **Control Panel**.
4. Click **Add or Remove Programs**. The **Add or Remove Programs** dialog appears.
5. From the list, select **Multisim 9** and select **Remove**. Multisim 9 will be removed from your computer.

## 1.7 Uninstalling SUU

➤ To uninstall SUU:

1. Click the Windows **Start** button.
2. Click **Control Panel**.
3. Click **Add or Remove Programs**. The **Add or Remove Programs** dialog appears.
4. From the list, select **EWB Support and Upgrade Utility** and select **Remove**. SUU will be removed from the standalone workstation.

## 1.8 Uninstalling a Site Version

### 1.8.1 Uninstalling Standalone Multi-Station Installation

At each standalone workstation, perform the following procedure:

1. Ensure you have recorded the serial number.
2. Click the Windows **Start** button.
3. Click **Control Panel**.
4. Click **Add or Remove Programs**. The **Add or Remove Programs** dialog appears.
5. From the list, select **Multisim 9** and select **Remove**. Multisim 9 will be removed from the standalone workstation.

### 1.8.2 Uninstalling Network Installation

Only the workstation that was used to install Multisim 9 to the network directory (host computer) can be used to remove it. Performing the steps below on other workstations (client computer) will only remove the Multisim 9 folder.

- To uninstall Multisim 9 from the network directory or the Multisim 9 folder:
  1. Ensure that you have recorded the serial number prior to uninstalling Multisim 9.
  2. Click the Windows **Start** button.
  3. Click **Control Panel**.
  4. Click **Add or Remove Programs**. The **Add or Remove Programs** dialog appears.
  5. From the list, select Multisim 9 and select **Remove**. If the workstation is the host computer, Multisim 9 is removed from the network directory. If the workstation is only a client computer, the Multisim 9 folder is removed.

### 1.8.3 Uninstalling Combination Standalone Multi-Station and Network Installations

Follow the instructions in “1.8.1 Uninstalling Standalone Multi-Station Installation” on page 1-17 and “1.8.2 Uninstalling Network Installation” on page 1-17, as necessary.

## 1.9 Uninstalling NLS

- To uninstall NLS:
  1. Click the Windows **Start** button.
  2. Click **Control Panel**.
  3. Click **Add or Remove Programs**. The **Add or Remove Programs** dialog appears.
  4. From the list, select **EWB Network License Server** and select **Remove**. SUU will be removed from the standalone workstation.

# Chapter 2

## Multisim Tutorial



This chapter contains a tutorial that introduces you to Multisim.

Some of the features described in this chapter may not be available in your edition of Multisim 9. Such features have an icon in the column next to their description. Refer to the release notes for a list of the features in your edition.

The following are described in this chapter.

Subject	Page No.
<b>The Electronics Workbench Suite</b>	2-1
<b>Multisim 9 Tutorial</b>	2-2
Schematic Capture	2-3
Simulation	2-9

## 2.1 The Electronics Workbench Suite

Electronics Workbench provides a suite of EDA (Electronics Design Automation) tools that assist you in carrying out the major steps in the circuit design flow. The suite consists of the following major components:

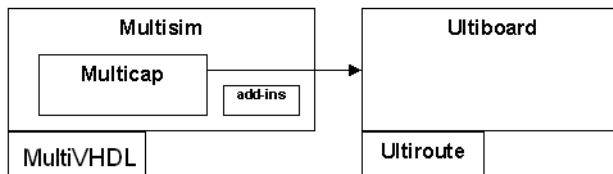

*Multicap* is a schematic capture program suitable for pure schematic entry, driving simulation, and feeding to downstage steps, such as PCB layout. *Multisim* includes all of *Multicap* and adds mixed analog/digital simulation capability. *MultiVHDL* adds HDL model creation and



co-simulation to Multisim. Depending on your tier of Multisim, optional add-ons may be available, such as for RF simulation and extended parts libraries.

*Ultiboard*, fed from Multicap or Multisim, is used to design printed circuit boards, perform certain basic mechanical CAD operations, and prepare them for manufacturing. *Ultroute* is an add-on to Ultiboard that provides automated parts placement and layout beyond what is available in Ultiboard stand-alone.

All of the products in the Electronics Workbench suite are available in multiple tiers depending upon budget and needs.

## 2.2 Multisim 9 Tutorial

This tutorial leads you through the circuit design flow, from schematic capture, through simulation and analysis. After following the steps outlined on the following pages, you will have designed a circuit that samples a small analog signal, amplifies it and then counts the occurrences of the signal on a simple digital counter.

Helpful tips are indicated by the presence of an icon in the left column, as in:



You can access the online help at any time by pressing F1 on your keyboard, or by clicking on the **Help** button in a dialog box.

When you get to the wiring section of this tutorial, you can carry on with the circuit you created in the component placement section, or open the file "Tut1.ms8" (which has all components properly placed) from the Tutorial folder (found inside the Samples folder) and proceed. When you arrive at the simulation section, you can carry on with the circuit you wired, or open the file "Tut2.ms8" (which has all components properly wired).

## 2.2.1 Schematic Capture

In this section, you will place and wire the components in the circuit shown below.

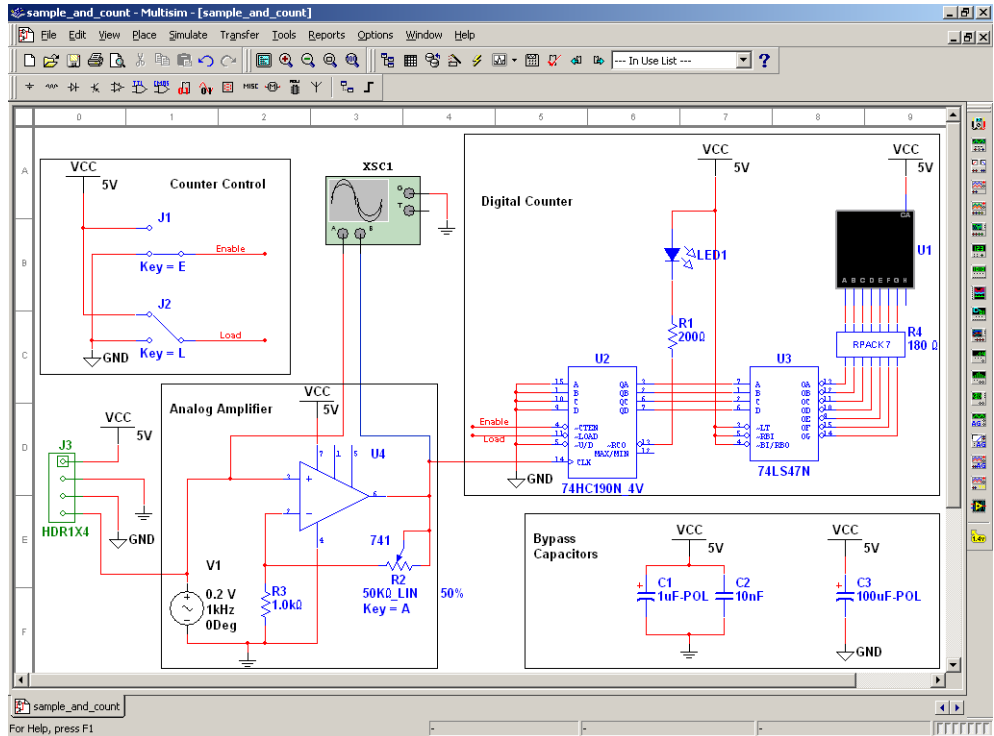

### Opening and Saving the File

When you first launch Multisim, a blank file is opened on the workspace called "Circuit1".

- To save the file with a new name:
  1. Select **File/Save As** to display a standard Windows Save dialog.
  2. Navigate to the location where you wish the file to reside, and enter "sample\_and\_count" as the filename, and click on the **Save** button.



To guard against accidental loss of data, set up a timed auto-backup of the file in the **Save** tab of the **Preferences** dialog box.

- To open an existing file:
  1. Select **File/Open**, navigate to the location where the file resides, highlight the file, and click on the **Open** button.



You can import legacy OrCAD® or PSpice® files by selecting the desired type that appears in the "Files of Type" drop-down list of the Windows Open dialog.



To view files from earlier versions of Multisim, select the desired version in the **Files of Type** drop-down in the **Open** dialog.

*Placing the Components*

1. Open sample\_and\_count.ms9 as described above.
2. Select **Place/Component** to display the **Select a Component** browser, navigate to the 7-segment LED display as shown below and click **OK**. The component appears as a "ghost" on the cursor.



Once you have selected the desired **Group** and **Family**, start typing the component's name. As you type, the string appears in the **Searching** field at the bottom of the browser. In the above example, type SEVEN\_SEG\_DECIMAL\_COM\_A\_BLUE. Matches are displayed as you type.

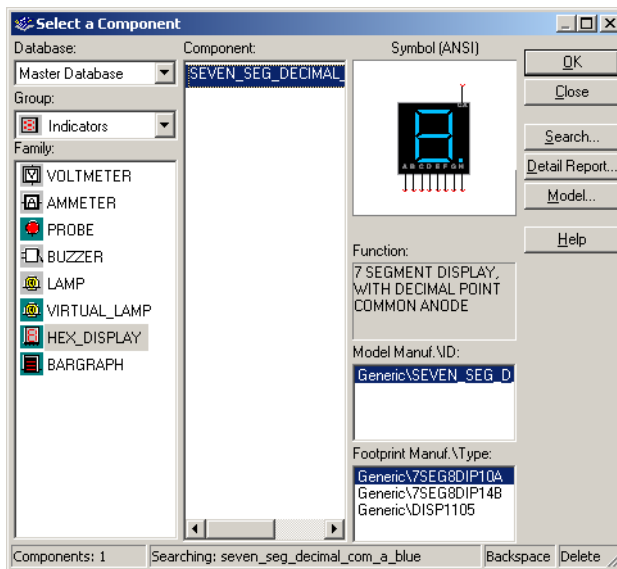

3. Move the cursor to the top-right of the workspace and left-click to place the component. Note that the Reference Designator for this component is "U1".

- Place the remaining components in the Digital Counter area as shown below.

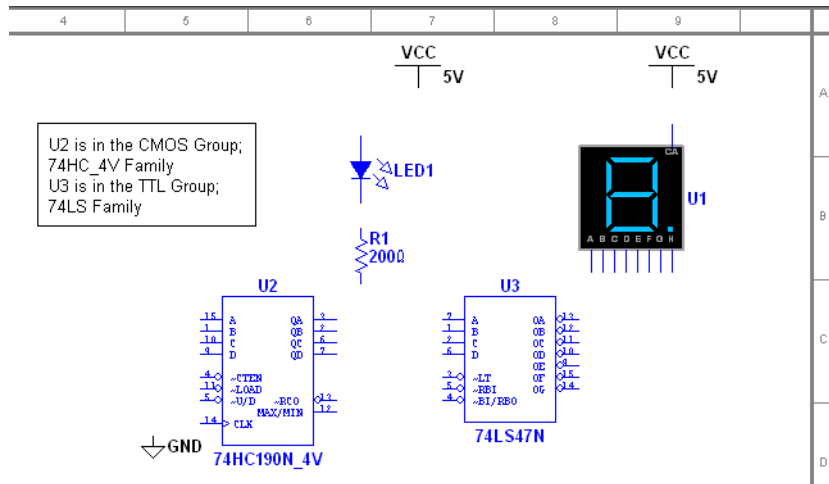

While placing the 200-ohm resistor, rotate it to a vertical orientation by pressing CTRL-R on your keyboard.



Reference Designators (e.g., U1, U2) are assigned in the order the components are placed. If you place components in a different order than in the original circuit, the numbering will differ. This will not effect the operation of the circuit in any way.

- Place the parts in the Counter Control section. After placement, right-click on each of the SPDT switches and select **Flip Horizontal**.

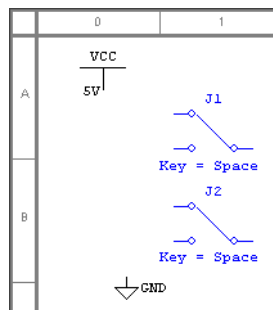

The SPDT switches are in the Basic Group; Switch Family



When a part is on the workspace and you want to place the same part again, highlight it and select **Edit/Copy**, then **Edit/Paste**.

6. Place the parts in the Analog Amplifier section as shown below, rotating as needed.

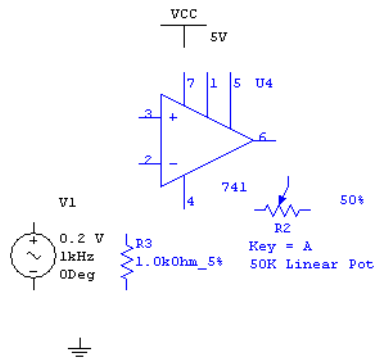

After you place the AC voltage signal source, double-click on it. Change the **Voltage (Pk)** to 0.2 V and click **OK** to close the dialog.

7. Place the parts in the Bypass Capacitors section as shown below.

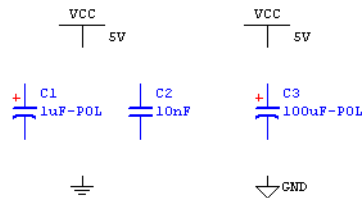

8. Place the header and associated parts as shown below.



Once you have wired a circuit, you can drop two-pinned passive components like resistors directly onto a wire. The connection is automatically made by Multisim.

#### Wiring the Circuit

Multisim is modeless; there are no wiring or part placement modes to toggle between. All components have pins that you use to wire them to other components or instruments. As soon as your cursor is over a pin, Multisim knows you want to wire and the pointer changes to a crosshair.



- Wire the Counter Control section as shown below. Select **Place/Junction** to place a junction beside J1. Repeat for J2 and wire the junctions to each switch as shown.

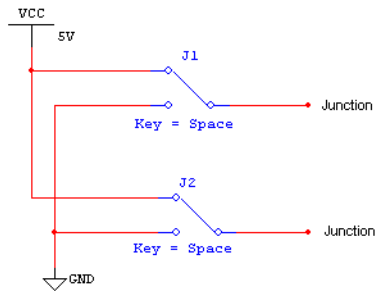

*Virtual Wiring* - To avoid clutter, this circuit uses virtual connections between the Counter Control and Digital Counter sections. A virtual connection is achieved when two unconnected wires are given the same net name. (A net represents a group of pins wired together at the same electrical point).



If the net names are not showing, select **Options/Sheet Properties** and click on the **Circuit** tab in the **Sheet Properties** dialog box that appears. Select **Show All** in the **Net Names** area.

- Change the net name of the wire to the right of J1, by double-clicking on the wire and entering "ENABLE" in the **Net Name** field of the **Net** dialog that appears.
- Change the net name of the wire to the right of J2 to "LOAD".
- Place and wire junctions to U2 as shown below. Then rename the nets to "ENABLE" and "LOAD". When prompted that nets already exist with these names, click **Yes** to continue.

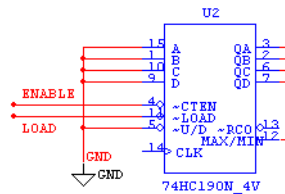
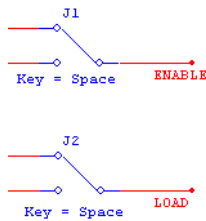

9. Finish wiring the circuit as shown below.

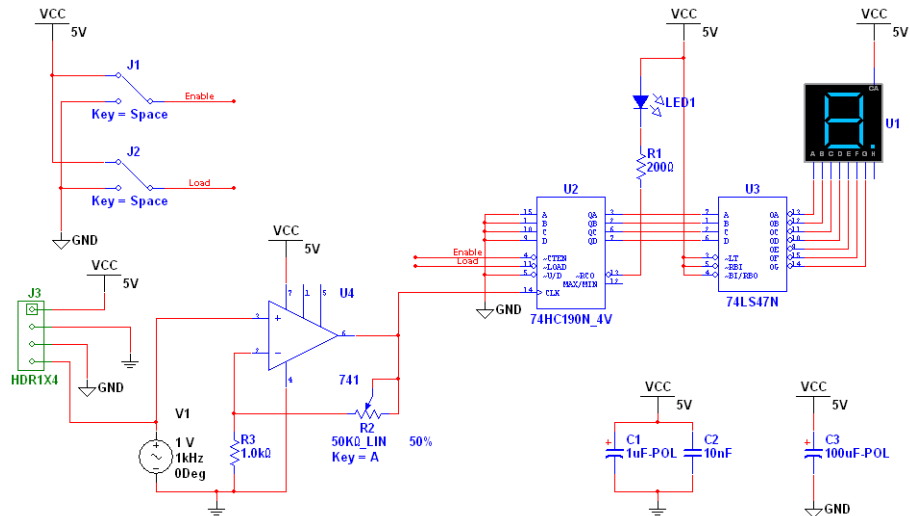

## 2.2.2 Simulation

Simulating your circuits with Multisim catches errors early in the design flow, saving time and money.

### *Virtual Instrumentation*

In this section, you will simulate the circuit with the virtual oscilloscope.

You can also use "Tut2.ms9" from the Tutorial folder (found inside the Samples folder).



1. J1, J2 and R2 are interactive components.

Set up the interactive keys for J1 and J2 by double-clicking on each. In the **Key for Switch** field, enter "E" for J1 and "L" for J2.

Press "E" to enable the counter.

2. Select **Simulate/Instruments/Oscilloscope** to place the oscilloscope on the workspace. Wire the instrument as shown in step 4.



To easily differentiate between traces on the oscilloscope, right-click on the wire connected to the scope's "B" input and select **Segment Color** from the pop-up. Select a color that differs from the wire connected to the "A" input, for example blue. (Simulation cannot be running when changing wire color).

3. Double-click on the scope's icon to show the instrument face. Select **Simulate/Run**. The output of the opamp appears on the scope.



- Adjust the Timebase to 2mS/Div and Channel A's Scale to 500mV/Div. You will see the following displayed on the scope.

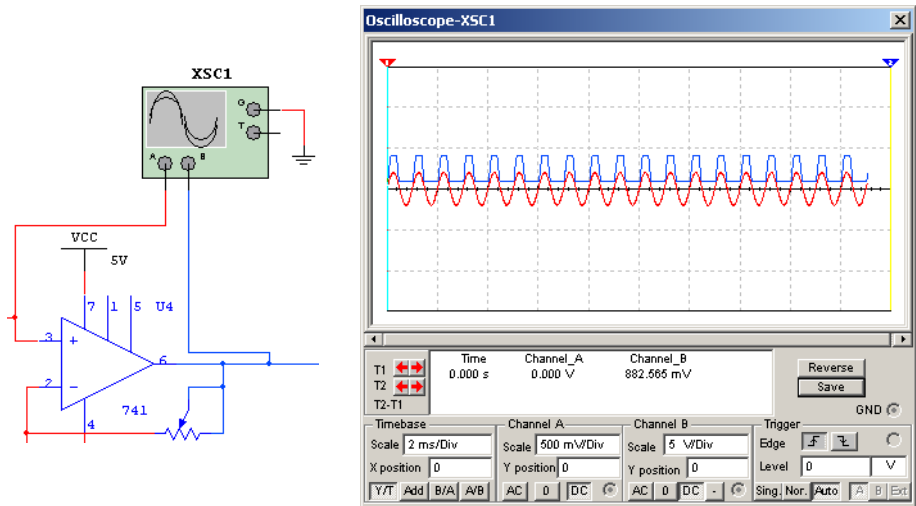

As the circuit simulates, the 7-segment display counts up and the LED flashes at the end of each count cycle.

- Press "E" on your keyboard while the simulation is running to enable or disable the counter. Enable is Active Low.

Press "L" to load zeros into the counter. Load is Active Low.

Press "Shift-A" to observe the effect of changing the potentiometer's setting. Repeat, pressing "A".



Remember to click on the schematic or the interactive components' keys will not work.

### Analysis

For this circuit, you will use **AC Analysis** to verify the frequency response of the amplifier.

- To perform an **AC Analysis** at the output of the opamp:
  - Double-click on the wire that is attached to pin 6 of the opamp, and change the net name to "ANALOG\_OUT" in the **Net** dialog box.

2. Select **Simulate/Analyses/AC Analysis** and click on the **Output** tab.

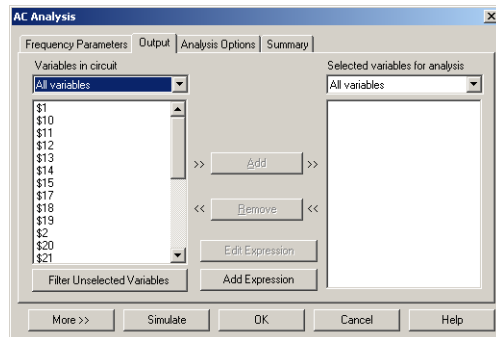

3. Highlight `$analog_out` in the left column and click **Add**. `$analog_out` moves to the right column.
4. Click **Simulate**. The results of the analysis appear in the **Grapher**.

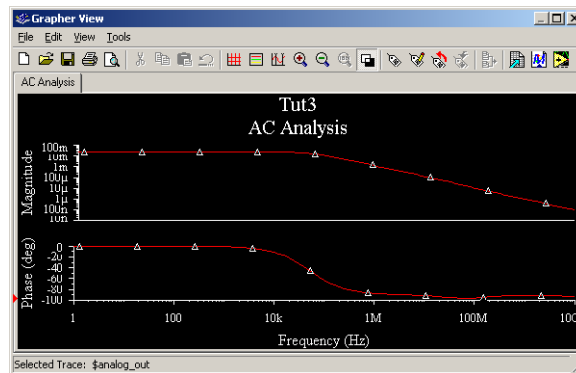

### *The Grapher*

The **Grapher** is a multi-purpose display tool that lets you view, adjust, save and export graphs and charts. It is used to display the results of all Multisim analyses in graphs and charts and a graph of traces for some instruments (for example the results of the oscilloscope).

- To view results of a simulation on the **Grapher**:
1. Run the simulation as described earlier.
  2. Select **View/Grapher**.

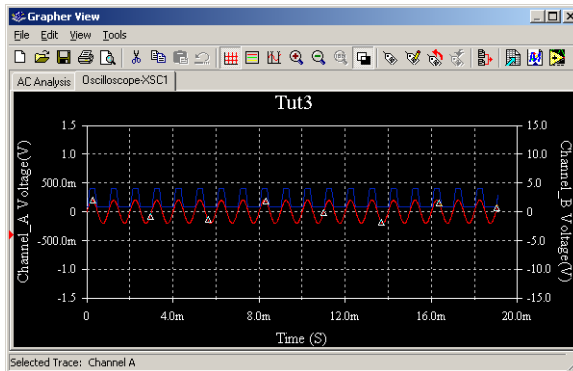

### *The Postprocessor*

The **Postprocessor** lets you manipulate the output from analyses performed on a circuit and plot the results on a graph or chart. Types of mathematical operations that can be performed on analysis results include arithmetic, trigonometric, exponential, logarithmic, complex, vector and logic. Detailed **Postprocessor** information can be found in Chapter 12, “Postprocessor”.

### *Reports*

Multisim allows you to generate a number of reports: Bill of Materials (BOM), Component Detail Report, Netlist Report, Schematic Statistics, Spare Gates and the Cross Reference Report. This section uses the **BOM** as an example for the tutorial circuit.

A bill of materials lists the components used in your design and therefore provides a summary of the components needed to manufacture the circuit board. Information provided in the

**Bill of Materials** includes:

- quantity of each component needed
- description, including the type of part (example: resistor) and value (examples: 5.1 kohm)
- Reference Designator of each component
- package or footprint of each component

- To create a **BOM** for your circuit:
  1. Click the **Reports** menu and choose **Bill of Materials** from the menu that appears.
  2. The report appears, looking similar to this:

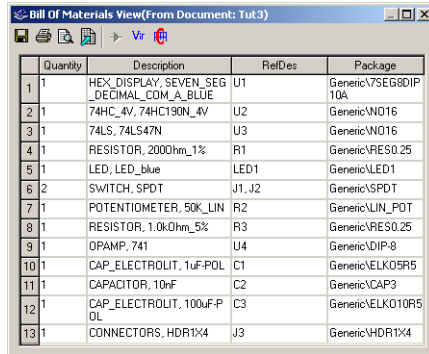

Quantity	Description	RefDes	Package
1	HEX_DISPLAY_SEVEN_SEG_DECIMAL_COM_A_BLUE	U1	Generic\7SEG8DIP10A
2	74HC_4V, 74HC190N_4V	U2	Generic\N016
3	74LS, 74LS47N	U3	Generic\N016
4	RESISTOR, 2000hm, 1%	R1	Generic\VRES0.25
5	LED, LED_blue	LED1	Generic\LED1
6	SWITCH, SPDT	J1, J2	Generic\SPDT
7	POTENTIOMETER, 50K_LIN	R2	Generic\LIN_POT
8	RESISTOR, 1.0kOhm, 5%	R3	Generic\VRES0.25
9	OPAMP, 741	U4	Generic\DIP-8
10	CAP_ELECTROLIT, 1uF-POL	C1	Generic\ELK05R5
11	CAPACITOR, 10nF	C2	Generic\CAP3
12	CAP_ELECTROLIT, 100uF-POL	C3	Generic\ELK010R5
13	CONNECTORS, HDR1X4	J3	Generic\HDR1X4



- To print the **Bill of Materials**, click the **Print** button. A standard Windows print screen appears, allowing you to choose the printer, number of copies, and so on.



- To save the **Bill of Materials** to a file, click the **Save** button. A standard Windows file save dialog box appears, allowing you to specify the path and file name.

Because the **Bill of Materials** is primarily intended to assist in procurement and manufacturing, it includes only “real” parts. That is, it excludes parts that are not real or able to be purchased, such as sources or virtual components.



- To see a list of components in your circuit that are not “real” components, click the **Virtual** button. A separate window appears, showing these components only.

Detailed information on this and other reports can be found in Chapter 13, “Reports”.

# Chapter 3

## User Interface



This chapter explains the basic operation of the Multisim 9 user interface.

Some of the features described in this chapter may not be available in your edition of Multisim 9. Such features have an icon in the column next to their description. Refer to the release notes for a list of the features in your edition.

The following are described in this chapter.

<b>Subject</b>	<b>Page No.</b>
<b>Introduction to the Multisim Interface</b>	3-3
<b>Toolbars</b>	3-4
Standard Toolbar	3-5
Main Toolbar	3-6
View Toolbar	3-7
Components Toolbar	3-8
Virtual Toolbar	3-9
Graphic Annotation Toolbar	3-10
Instruments Toolbar	3-11
<b>Using the Pop-up Menus</b>	3-12
Pop-up From Circuit Window, with no Component Selected	3-13
Pop-up From a Selected Component or Instrument	3-15
Pop-up From a Selected Wire	3-17
Pop-up From a Selected Text Block or Graphic	3-17
Pop-up From a Title Block	3-18
Pop-up from a Comment or Measurement Probe	3-19

<b>Subject</b>	<b>Page No.</b>
<b>Setting Schematic Capture Preferences</b>	3-20
Using the Preferences Dialog Box	3-20
Using the Sheet Properties Dialog Box	3-25
<b>Design Toolbox</b>	3-34
Visibility Tab	3-34
Hierarchy Tab	3-35
<b>Customizing the Interface</b>	3-37
Commands tab	3-38
Toolbars tab	3-39
Keyboard tab	3-40
Menu tab	3-41
Options tab	3-42
Customization Pop-up Menus	3-42
Other Customization Options	3-43

## 3.1 Introduction to the Multisim Interface

Multisim's user interface consists of the following basic elements:

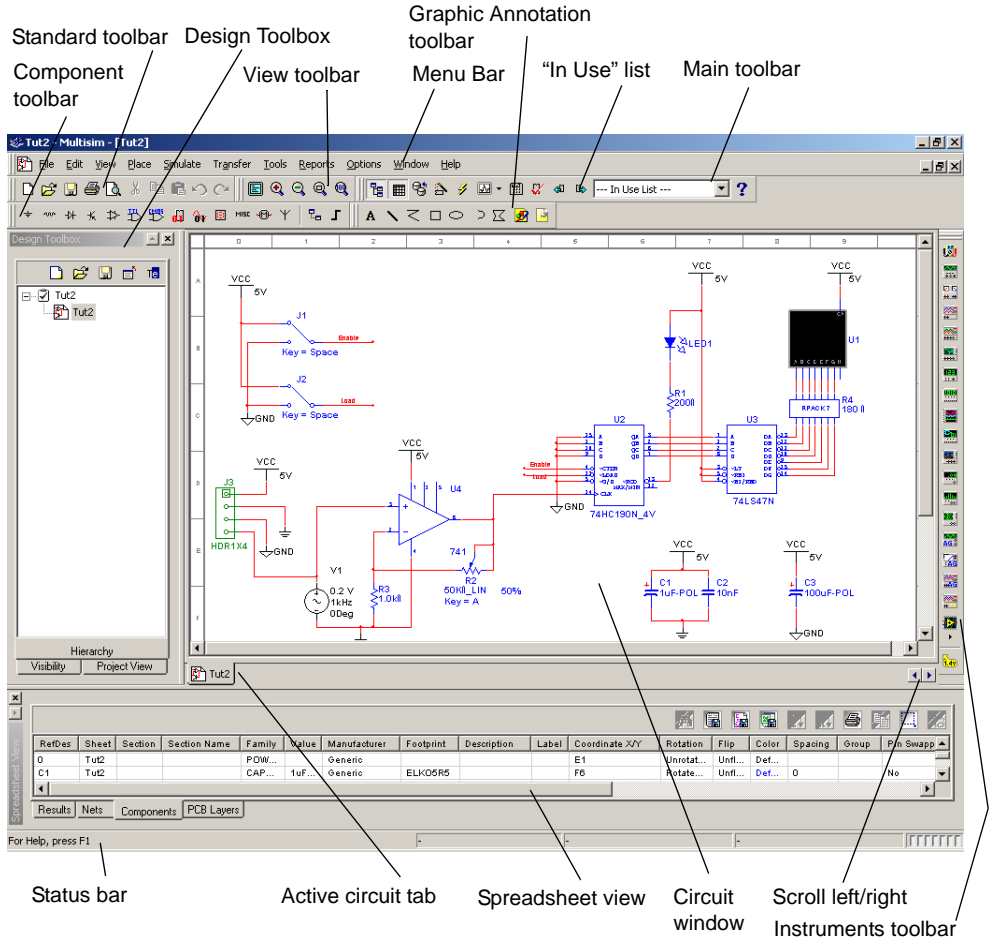

**Menus** are where you find commands for all functions. For details, see “A.1 Multisim Menu” on page A-1.

The **Standard** toolbar contains buttons for commonly-performed functions, as described in “3.2.1 Standard Toolbar” on page 3-5.

The **Instruments** toolbar contains buttons for each instrument, as described in “10.1 Introduction to the Multisim Instruments” on page 10-3.

The **Component** toolbar contains buttons that let you select components from the Multisim databases for placement in your schematic. See “3.2.4 Components Toolbar” on page 3-8.

The **Circuit Window** (or workspace) is where you build your circuit designs.

The **Status Bar** displays useful information about the current operation and a description of the item the cursor is currently pointing to.

The **Design Toolbox** lets you navigate through the different types of files in a project (schematics, PCBs, reports), view a schematic’s hierarchy and show or hide different layers. For details, see “3.5 Design Toolbox” on page 3-34.



The **Spreadsheet View** allows fast advanced viewing and editing of parameters including component details such as footprints, RefDes, attributes and design constraints. Users can change parameters for some or all components in one step and perform a number of other functions. For details, see “5.2 The Spreadsheet View” on page 5-9.

## 3.2 Toolbars

The toolbars listed below are available in Multisim:

- Standard Toolbar
- Main Toolbar
- View Toolbar
- Components Toolbar
- Virtual Toolbar
- Graphic Annotation Toolbar
- Instruments Toolbar

**Note** If the above toolbars are not visible, select **View/Toolbars/<toolbar name>**.

**Note** For a description of the menus and commands found in Multisim, refer to “A.1 Multisim Menus” on page A-1.











## 3.2.1 Standard Toolbar

The **Standard** toolbar contains buttons for commonly performed functions.









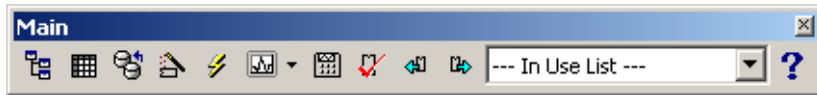

The buttons in the **Standard** toolbar are described below:



Button	Description
	<b>New</b> button. Creates a new circuit file.
	<b>Open</b> button. Opens an existing circuit file.
	<b>Save</b> button. Saves the active circuit.
	<b>Print Circuit</b> button. Prints the active circuit.
	<b>Print Preview</b> button. Previews the circuit as it will be printed.
	<b>Cut</b> button. Removes the selected elements and places them on the Windows clipboard.
	<b>Copy</b> button. Copies the selected elements and places them on the Windows clipboard.
	<b>Paste</b> button. Inserts the contents of the Windows clipboard at the cursor location.

## 3.2.2 Main Toolbar



The buttons in the **Main** toolbar are described below:





Button	Description
	<b>Toggle Design Toolbox</b> button. Switches the Design Toolbox on and off. For details, see “3.5 Design Toolbox” on page 3-34.
	<b>Toggle Spreadsheet View</b> button. Switches the Spreadsheet View on and off. For details, see “5.2 The Spreadsheet View” on page 5-9. This feature is not available in all versions of Multisim.
	<b>Database Manager</b> button. Launches the <b>Database Manager</b> dialog box. For details, see “8.3 Editing Components” on page 8-12.
	<b>Create Component</b> button. Launches the <b>Component Wizard</b> . For details, see “8.2 Adding Components with the Component Wizard” on page 8-4.
	<b>Run/stop Simulation</b> button. Starts/stops simulation of the active circuit. For details, see “9.2.1 Start/Stop/Pause Simulation” on page 9-4.
	<b>Grapher/Analyses</b> button. Displays the grapher. For details, see “11.2 Viewing the Analysis Results: Grapher” on page 11-4. Also displays a list of available analyses. For details, see “11.3 Working with Analyses” on page 11-23.
	<b>Postprocessor</b> button. Displays the <b>Postprocessor</b> dialog box. For details, see “12.2 Using the Postprocessor” on page 12-2.
	<b>Electrical Rules Checking</b> button. Checks that the electrical rules established for the wiring of the circuit have been followed. For details, see “5.4 Electrical Rules Checking” on page 5-34.

Button	Description
	<b>Back Annotate from Ultiboard</b> button. For details, see “14.4 Back Annotation” on page 14-5.
	<b>Forward Annotate</b> button. For details, see “14.3 Forward Annotation” on page 14-4.
	<b>In Use List</b> (not shown here). Click on the arrow to display a list of the active circuit’s components. For details, see “4.4.3 Using the In Use List” on page 4-13.
	<b>Help</b> button. Launches the help file.

### 3.2.3 View Toolbar













The buttons in the **View** toolbar are described below:





Button	Description
	<b>Toggle Full Screen</b> button. Displays only the workspace, with no toolbars or menu items.
	<b>Increase Zoom</b> button. Magnifies the active circuit.
	<b>Decrease Zoom</b> button. Decreases the magnification of the active circuit.
	<b>Zoom Area</b> button. Drag the cursor to select an area on the workspace to magnify.
	<b>Zoom Fit to Page</b> button. Shows the entire circuit in the workspace.

## 3.2.4 Components Toolbar



The buttons in the **Component** toolbar are described below. Each button will launch the place component browser (**Select a Component** browser) with the group specified on the button pre-selected. For details, see “4.4.1 Using the place component browser” on page 4-4.

Button	Description
	<b>Source</b> button. Selects the Source components group in the browser.
	<b>Basic</b> button. Selects the Basic components group in the browser.
	<b>Diode</b> button. Selects the Diode components group in the browser.
	<b>Transistor</b> button. Selects the Transistor components group in the browser.
	<b>Analog</b> button. Selects the Analog components group in the browser.
	<b>TTL</b> button. Selects the TTL components group in the browser.
	<b>CMOS</b> button. Selects the CMOS component group in the browser.
	<b>Miscellaneous Digital</b> button. Selects the Miscellaneous Digital component group in the browser.
	<b>Mixed</b> button. Selects the Mixed component group in the browser.
	<b>Indicator</b> button. Selects the Indicator component group in the browser.
	<b>Miscellaneous</b> button. Selects the Miscellaneous component group in the browser.

Button	Description
	<b>Electromechanical</b> button. Selects the Electromechanical component group in the browser.
	<b>RF</b> button. Selects the RF component group in the browser.
	<b>Place Hierarchical Block</b> button. Opens a file to be embedded as a hierarchical block.
	<b>Place Bus</b> button. For details, see “6.4 Buses” on page 6-16.

## 3.2.5 Virtual Toolbar

Use the **Virtual** toolbar to place virtual components on your workspace.

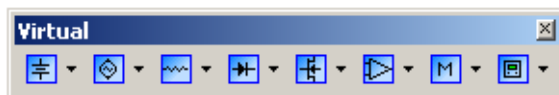





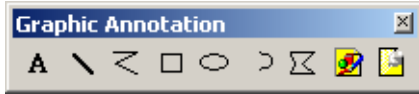



The buttons in the **Virtual** toolbar are described in “4.4.2 Placing Virtual Components” on page 4-9.

## 3.2.6 Graphic Annotation Toolbar



The buttons in the **Graphic Annotation** toolbar are described below. For details on their use, see “4.9.6 Graphic Annotation” on page 4-43.











Button	Description
	<b>Place Text</b> button. Places a text frame on your workspace into which you can enter miscellaneous text. For details, see “4.9.4 Adding Miscellaneous Text” on page 4-39.
	<b>Line</b> button. Click on this button to draw a line.
	<b>Multiline</b> button. Click on this button to draw a multiline.
	<b>Rectangle</b> button. Click on this button to draw a rectangle.
	<b>Ellipse</b> button. Click on this button to draw an ellipse.
	<b>Arc</b> button. Click on this button to draw an arc.
	<b>Polygon</b> button. Click on this button to draw a polygon.
	<b>Picture</b> button. Click on this button to place a picture on the workspace.
	<b>Place Comment</b> button. Click on this button to place a comment on the workspace. For details, see “4.9.5 Adding a Comment” on page 4-40.









## 3.2.7 Instruments Toolbar



The buttons in the **Instruments** toolbar are described below. In each case, the button places a specific instrument on the workspace.

Some versions of Multisim do not include all of the instruments noted below.

Button	Description
	<b>Multimeter</b> button. Places a multimeter on the workspace. For details, see “10.4 Multimeter” on page 10-10.
	<b>Function Generator</b> button. Places a function generator on the workspace. For details, see “10.5 Function Generator” on page 10-14.
	<b>Wattmeter</b> button. Places a wattmeter on the workspace. For details, see “10.6 Wattmeter” on page 10-17.
	<b>Oscilloscope</b> button. Places an oscilloscope on the workspace. For details, see “10.7 Oscilloscope” on page 10-18.
	<b>Four Channel Oscilloscope</b> button. Places a four-channel oscilloscope on the workspace. For details, see “10.16 Four-channel Oscilloscope” on page 10-47.
	<b>Bode Plotter</b> button. Places a bode plotter on the workspace. For details, see “10.8 Bode Plotter” on page 10-23.
	<b>Frequency Counter</b> button. Places a frequency counter on the workspace. For details, see “10.17 Frequency Counter” on page 10-57.
	<b>Word Generator</b> button. Places a word generator on the workspace. For details, see “10.9 Word Generator” on page 10-28.
	<b>Logic Analyzer</b> button. Places a logic analyzer on the workspace. For details, see “10.10 Logic Analyzer” on page 10-31.
	<b>Logic Converter</b> button. Places a logic converter on the workspace. For details, see “10.11 Logic Converter” on page 10-35.
	<b>IV-Analysis</b> button. Places an IV Analyser on the workspace. For details, see “10.18 IV Analyzer” on page 10-60.

Button	Description
	<b>Distortion Analyzer</b> button. Places a distortion analyzer on the workspace. For details, see “10.12 Distortion Analyzer” on page 10-38.
	<b>Spectrum Analyzer</b> button. Places a spectrum analyzer on the workspace. For details, see “10.13 Spectrum Analyzer” on page 10-40.
	<b>Network Analyzer</b> button. Places a network analyzer on the workspace. For details, see “10.14 Network Analyzer” on page 10-40.
	<b>Agilent Function Generator</b> button. Places an Agilent function generator on the workspace. For details, see “10.19.1 Agilent Simulated Function Generator” on page 10-71.
	<b>Agilent Multimeter</b> button. Places an Agilent multimeter on the workspace. For details, see “10.19.2 Agilent Simulated Multimeter” on page 10-74.
	<b>Agilent Oscilloscope</b> button. Places an Agilent oscilloscope on the workspace. For details, see “10.19.3 Agilent Simulated Oscilloscope” on page 10-77.
	<b>Tektronix Oscilloscope</b> button. Places a Tektronix oscilloscope on the workspace. For details, see “10.20 Tektronix Simulated Oscilloscope” on page 10-82.
	<b>LabVIEW Instrument</b> button. Places a LabVIEW instrument on the workspace. For details, see “10.23 LabVIEW Instruments” on page 10-87.
	<b>Measurement Probe</b> button. Attaches a probe to the mouse pointer that measures voltage, current and frequency on any wire on your schematic. Can be placed before, or during simulation. For details, see “10.15 Measurement Probe” on page 10-40.

### 3.3 Using the Pop-up Menus

In addition to the standard menus at the top of the screen (File, Edit, etc.), there are also a number of context-sensitive pop-up menus available.



### 3.3.1 Pop-up From Circuit Window, with no Component Selected

If you right-click on the circuit window with no component selected, a pop-up menu of appropriate commands appears. These commands are:

Command	Description
Place Component	Lets you browse the databases (“Master”, “Corporate” and “User”) for components to be placed. For details, see “4.4.1 Using the place component browser” on page 4-4.
Place Schematic - Component	Lets you browse the databases (“Master”, “Corporate” and “User”) for components to be placed. For details, see “4.4.1 Using the place component browser” on page 4-4.
Place Schematic - Junction	Places a connector. For details, see “4.6 Manually Adding a Junction (Connector)” on page 4-29.
Place Schematic - Wire	Use to place a wire on the workspace. For details, see “4.5.5 Placing Wires Directly Onto Workspace” on page 4-26.
Place Schematic - Bus	Places a bus with segments created as you click. For details, see “6.4 Buses” on page 6-16.
Place Schematic - HB/SC Connector	Adds connectors to a circuit for use in a hierarchical block or a subcircuit.
Place Schematic - Off-Page Connector	Places an off-page connector on your workspace. For details, see “6.1 Flat Multi-sheet Design” on page 6-2.
Place Schematic - Bus HB/SC Connector	Adds bus connectors to a circuit for use in a hierarchical block or a subcircuit.
Place Schematic - Bus Off-Page Connector	Places an off-page connector for use with buses only on your workspace.
Place Schematic - Hierarchical Block from File	Opens a file to be embedded as a hierarchical block. For details, see “6.2.5.1 Placing a HB from an Existing File” on page 6-8.
Place Schematic - New Hierarchical Block	Displays the Hierarchical Block Properties dialog box. For details, see “6.2.5 Adding a Hierarchical Block” on page 6-7.
Place Schematic - Replace by Hierarchical Block	Replaces the selection by a hierarchical block.
Place Schematic - New Subcircuit	Places a new subcircuit on the workspace. For details, see “6.2.6 Adding a Subcircuit” on page 6-9.

<b>Command</b>	<b>Description</b>
Place Schematic - Replace by Subcircuit	Replaces the selection by a subcircuit.
Place Schematic - Multi-Page	Opens a new flat page. For details, see “6.1 Flat Multi-sheet Design” on page 6-2.
Place Schematic - Merge Bus	Merges selected buses.
Place Schematic - Bus Vector Connect	Use to place numerous connections from a multi-pinned device, such as an IC, to a bus. For details, see “6.4.5 Bus Vector Connect” on page 6-27.
Place Graphic - Text	Lets you place text on the circuit. For details, see “4.9.4 Adding Miscellaneous Text” on page 4-39.
Place Graphic - Line	Places a straight line on your workspace. For details, see “4.9.6 Graphic Annotation” on page 4-43.
Place Graphic - Multiline	Places a multiline on your workspace. For details, see “4.9.6 Graphic Annotation” on page 4-43.
Place Graphic - Rectangle	Places a rectangle on your workspace. For details, see “4.9.6 Graphic Annotation” on page 4-43.
Place Graphic - Ellipse	Places an ellipse on your workspace. For details, see “4.9.6 Graphic Annotation” on page 4-43.
Place Graphic - Arc	Places an arc on your workspace. For details, see “4.9.6 Graphic Annotation” on page 4-43.
Place Graphic - Polygon	Places a polygon on your workspace. For details, see “4.9.6 Graphic Annotation” on page 4-43.
Place Graphic - Picture	Places a picture on your workspace. For details, see “4.9.6 Graphic Annotation” on page 4-43.
Place Comment	Use to “pin” a comment to the workspace, or directly to a component. For details, see “4.9.5 Adding a Comment” on page 4-40.
Cut	Removes the selected item from the circuit and places it on the clipboard.
Copy	Copies the selected item from the circuit to the clipboard.
Paste	Pastes the current contents of the clipboard onto your circuit.
Delete	Deletes the selection from the workspace.
Select All	Selects all elements on the workspace.

Command	Description
Paste as Subcircuit	Pastes the contents of the clipboard onto the workspace as a subcircuit.
Replace by HB	Replaces the elements that you have selected with a hierarchical block. See “6.2.5.2 Replacing Components with an HB” on page 6-9.
Replace by SC	Replaces the elements that you have selected with a subcircuit. See “6.2 Hierarchical Design” on page 6-3.
Font	Displays a dialog box where you set font information for the circuit. For details, see “3.4.2.4 Sheet Properties - Font Tab” on page 3-30.
Properties	Displays the <b>Sheet Properties</b> dialog box. Be sure that you have no elements on the workspace selected, or the properties for that element will appear instead. For details, see “3.4.2 Using the Sheet Properties Dialog Box” on page 3-25.

### 3.3.2 Pop-up From a Selected Component or Instrument

If you right-click on a selected element (component or instrument), a pop-up menu of appropriate commands appears. These commands are:

Command	Description
Cut	Removes the selected components, circuits or text, and places them on the clipboard.
Copy	Copies the selected components, circuits or text, and places them on the clipboard. For details, see “4.4.6 Copying a Placed Component” on page 4-16.
Paste	Places the contents of the clipboard to the workspace. The cursor shows a “ghosted” image of the item to be pasted. Click to indicate where the item is to be pasted.
Delete	Deletes the selection from the workspace.
Flip Horizontal	Flips the selection horizontally. For details, see “4.7 Rotating/Flipping Placed Components” on page 4-30.

Flip Vertical	Flips the selection vertically. For details, see “4.7 Rotating/Flipping Placed Components” on page 4-30.
90 Clockwise	Rotates the selection 90 degrees clockwise. For details, see “4.7 Rotating/Flipping Placed Components” on page 4-30.
90 CounterCW	Rotates the selection 90 degrees counterclockwise. For details, see “4.7 Rotating/Flipping Placed Components” on page 4-30.
Bus Vector Connect	Displays the Bus Vector Connect dialog box. For details, see “6.4.5 Bus Vector Connect” on page 6-27.
Replace by HB	Replaces the elements that you have selected with a hierarchical block. See “6.2.5.2 Replacing Components with an HB” on page 6-9.
Replace by SC	Replaces the elements that you have selected with a subcircuit. See “6.2 Hierarchical Design” on page 6-3.
Replace Components	Invokes the Select a Component browser from which you can select a new component. See also, “4.4.7 Replacing a Placed Component” on page 4-17.
Edit Symbol	You can edit either the appearance of the symbol on the workspace (In-place Edit Mode). For details, see “8.5.2 Creating and Editing a Component’s Symbol with the Symbol Editor” on page 8-17.
Color	Displays a color palette where you can change the color of the selected element’s lines.
Font	Changes the font of various elements on the workspace from their default values. For details, see “3.4.2.4 Sheet Properties - Font Tab” on page 3-30.
Properties	If a component is selected, displays that component’s properties dialog box. If an instrument is selected, opens the instrument face.

### 3.3.3 Pop-up From a Selected Wire

If you right-click on a selected wire on the circuit window, a pop-up menu of appropriate commands appears. These commands are:

Command	Description
Delete	Deletes the selected wire from the workspace.
Wire Color	Changes the color of the selected wire from its default value.
Segment Color	Changes the color of the selected wire <i>segment</i> from its default value.
Font	Changes the font of various elements on the workspace from their default values. For details, see “3.4.2.4 Sheet Properties - Font Tab” on page 3-30.
Properties	Displays the <b>Net</b> dialog box. “4.9.2 Modifying Net Names” on page 4-35.

### 3.3.4 Pop-up From a Selected Text Block or Graphic

If you right-click on a selected text block or graphic element in the circuit window, a pop-up menu of appropriate commands appears. These commands are:

Command	Description
Delete	Deletes the selected item.
Flip Horizontal	Flips the selection horizontally. For details, see “4.7 Rotating/Flipping Placed Components” on page 4-30.
Flip Vertical	Flips the selection vertically. For details, see “4.7 Rotating/Flipping Placed Components” on page 4-30.
90 Clockwise	Rotates the selection 90 degrees clockwise. For details, see “4.7 Rotating/Flipping Placed Components” on page 4-30.
90 CounterCW	Rotates the selection 90 degrees counterclockwise. For details, see “4.7 Rotating/Flipping Placed Components” on page 4-30.
Pen Color	Changes the color of the selected item from its default value.

<b>Command</b>	<b>Description</b>
Pen Style	Changes the style of the pen for a selected graphic. Is disabled if text is selected.
Fill Color	Changes the color of the fill for selected rectangles, ellipses and polygons. Is disabled if any other graphic element, or text is selected.
Fill Type	Changes the appearance of the fill for selected rectangles, ellipses and polygons. Is disabled if any other graphic element, or text is selected.
Arrow	Places an arrow on selected lines and multilines. Is disabled if any other graphic element, or text is selected.
Order	Use to Bring to Front or Send to Back selected element.
Assign to Layer	Places selected element on the selected layer. Deselect to remove an element from the assigned layer. See "3.4.2.6 Sheet Properties - Visibility Tab" on page 3-33.
Font	Lets you select a font, font style and size for selected text.
Properties	Is inactive for text blocks or graphics.

### 3.3.5 Pop-up From a Title Block

If you right-click on a selected title block in the circuit window, a pop-up menu of appropriate commands appears. These commands are:

<b>Command</b>	<b>Description</b>
Delete	Deletes the selected title block.
Edit Title Block	Launches the Title Block Editor. For details, see "5.3 Title Block Editor" on page 5-15. (To edit the selected title block, select Edit Symbol/Title Block).
Color	Displays a palette where you can change the selection's color.
Move to - Bottom Left	Places the selected title block at the bottom left corner of the document.
Move to - Bottom Right	Places the selected title block at the bottom right corner of the document.

Command	Description
Move to - Top Left	Places the selected title block at the top left corner of the document.
Move to - Top Right	Places the selected title block at the top right corner of the document.
Properties	Lets you change the information that you see in the title block. For details, see “4.9.3.1 Entering the Title Block Contents” on page 4-37.

### 3.3.6 Pop-up from a Comment or Measurement Probe

If you right-click on a selected wire on a selected **Comment** or **Measurement Probe**, a pop-up menu of appropriate commands appears. These commands are:

Command	Description
Cut	Removes the selected item and places it on the clipboard.
Copy	Copies the selected item and places it on the clipboard.
Paste	Places the contents of the clipboard to the workspace. The cursor shows a “ghosted” image of the item to be pasted. Click to indicate where the item is to be pasted.
Delete	Deletes the selected item from the workspace.
Show Comment/Probe	Displays the contents of the comment or placed probe.
Edit Comment	Is active for a selected comment only. Use to enter text into the comment.
Reverse Probe Direction	Is active for a selected probe only. Reverse’s the probe’s polarity.
Font	Changes the font of various elements on the workspace from their default values. For details, see “3.4.2.4 Sheet Properties - Font Tab” on page 3-30.
Properties	Depending on the element selected, displays either the <b>Comment Properties</b> , or the <b>Probe Properties</b> dialog box. See “4.9.5 Adding a Comment” on page 4-40 or “10.15.1.1 Measurement Probe Settings” on page 10-42.

## 3.4 Setting Schematic Capture Preferences

You can customize virtually any aspect of Multisim preferences, including the colors used in your circuit, page size, zoom level, auto-backup interval, symbol set (ANSI or DIN) and printer setup. Your customization settings are saved individually with each circuit file you use so you could, for example, have one color scheme for one circuit and another for a different circuit. You can also override the settings for individual instances (for example, change one particular component from red to orange) or for the entire circuit.

Customization is done through the:

- **Preferences** dialog box — used to set up global preferences. These preferences can vary from computer to computer. See “3.4.1 Using the Preferences Dialog Box” on page 3-20.
- **Sheet Properties** dialog box — used to set up the preferences for the active sheet. These preferences are saved with the circuit files so that if the circuit is opened on another computer, it will use the same settings. See “3.4.2 Using the Sheet Properties Dialog Box” on page 3-25

### 3.4.1 Using the Preferences Dialog Box

This section explains general procedures for setting preferences. The following sections describe details of setting specific options.

**Note** For sheet preferences, see “3.4.2 Using the Sheet Properties Dialog Box” on page 3-25.

➤ To set your user preferences:

1. Choose **Options/Global Preferences**. The **Preferences** dialog box appears, offering you the following tabs:
  - **Paths** — where you can change the filepaths for the databases and other items.
  - **Save** — where you set up Auto-backup timing and whether you want to save simulation data with instruments.
  - **Parts** — where you set up component placement mode and the symbol standard (ANSI or DIN). You also set up phase shift direction and digital simulation settings.
  - **General** — where you set up selection rectangle behavior, mouse wheel behavior, bus wiring and auto-wiring behavior.
2. Select the desired tab.
3. Set the desired customization options. The specific options and settings available in the tabs are described in the following sections of this chapter.
4. Click **OK** to save your changes.



### 3.4.1.1 Preferences - Paths Tab

The Multisim installation puts specific files in specific locations. If necessary you can point Multisim to a new location to find, for example, database files. You can also use this dialog box to create and specify user settings files that contain individuals' preferences for all options.

➤ To set up file locations:

1. Choose **Options/Global Preferences**. The **Preferences** dialog box appears.
2. Select the **Paths** tab and navigate to the appropriate locations for the different elements:

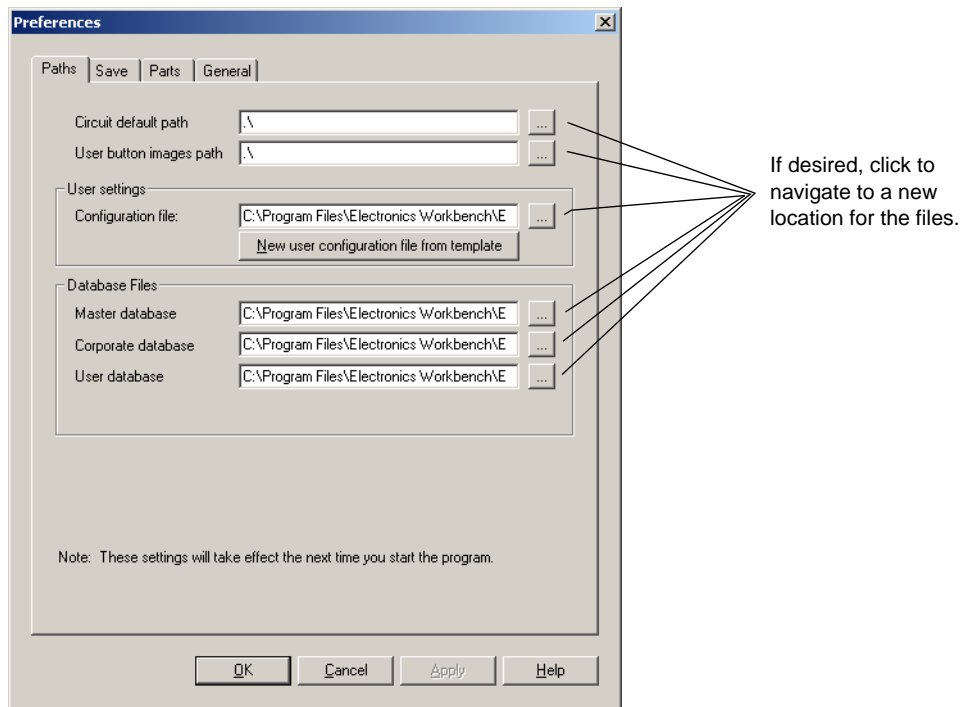

**Note** The most important setting is the **Circuit default path**, as this is where all new files are saved, unless you manually navigate to a new location when saving.

**Note** **User button images path** is where you store any user-created button graphics.

3. To use a different configuration file, navigate to the appropriate user settings file.
4. To create a new user configuration file, click **New user config file from template**. You are prompted to select the configuration file to use as a template, then to enter a name for the new configuration file.

### 3.4.1.2 Preferences - Save Tab

The options in this tab let you set up auto-backup timing and whether you want to save simulation data with instruments.

Enable to save a security copy when you do a Save.

Enables auto-backup.

Specify the interval at which auto-backup will be performed

Enable to save simulation data with instruments.

Enter maximum size of instrument simulation data.

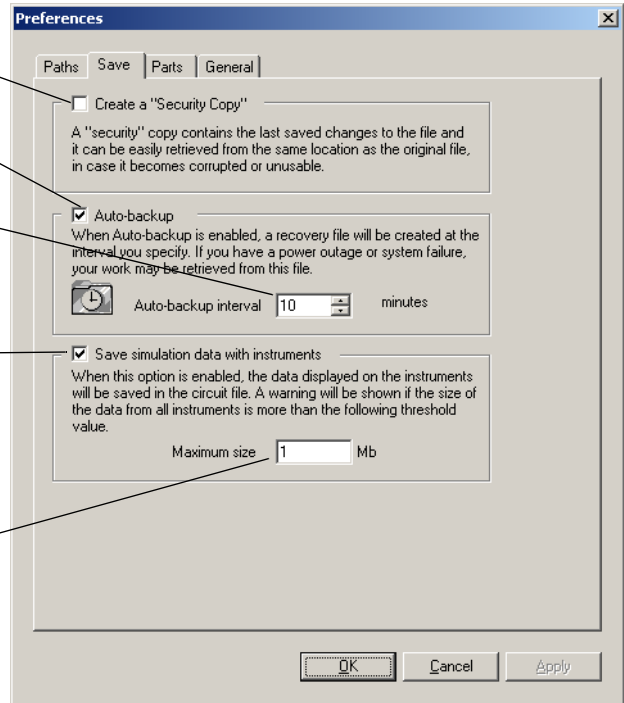

### 3.4.1.3 Preferences - Parts Tab

The options in this tab determine where you set up component placement mode, the symbol standard (ANSI or DIN), phase shift direction and digital simulation settings.

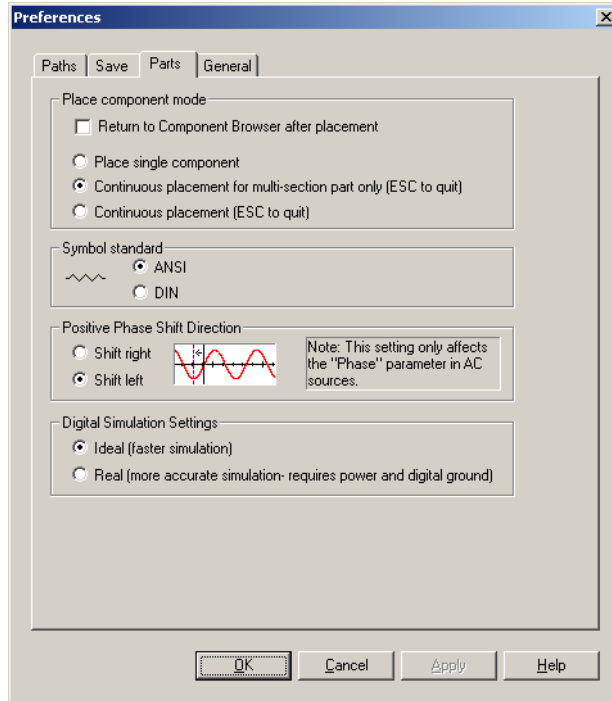

1. In the **Place component mode** box, select one of:

- **Place single component** — Allows you to place one selected component at a time.
- **Continuous placement for multi-section part only** — Allows you to place multiple sections of a multi-section component. For example, 7400N has four NAND gates, so using this option means each time you place a 7400N you place a different one of its NAND gates. Refer to “4.4.1 Using the place component browser” on page 4-4 for an example of multi-section part placement.
- **Continuous placement** — Allows you to place several components of the same type by continuing to click on the workspace after each component is placed. End continuous placement by pressing ESC.

Optionally, enable the **Return to Component Browser After Placement** checkbox to display the **Select a Component** dialog box after you place a component on the workspace. This is useful when you have many parts to place. (Click ESC when finished part placement).

2. In the **Symbol Standard** box:
  - Select the symbol set to be used for components. The graphic changes to represent the selected symbol set. To override this setting for individual components, see “8.5.2 Creating and Editing a Component’s Symbol with the Symbol Editor” on page 8-17.
3. In the **Positive Phase Shift Direction** box:
  - select the desired direction for positive phase shift. (This setting only affects the Phase parameter in AC sources).
4. In the **Digital Simulation Settings** box:
  - Set the realism of the output when simulating digital components. For details, see “9.3.7 Digital Simulation” on page 9-11.

### 3.4.1.4 Preferences - General Tab

In this tab, you set up selection rectangle behavior, mouse wheel behavior, bus wiring and auto-wiring behavior.

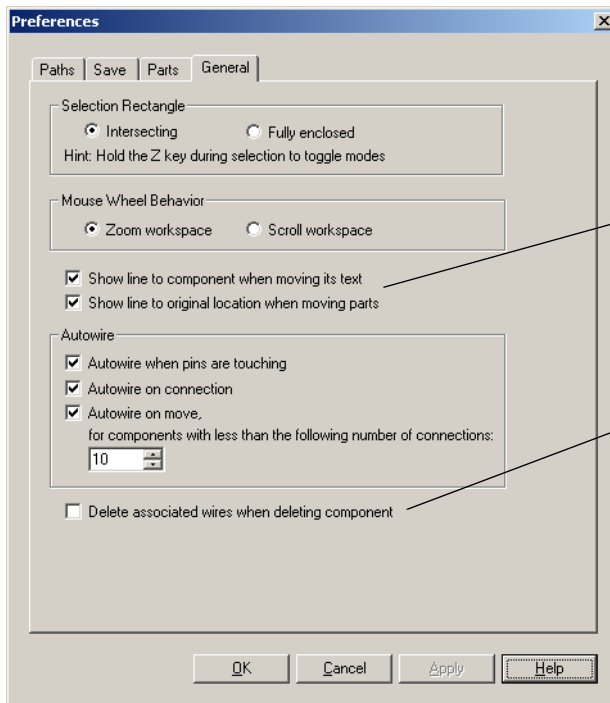

For details, see “Showing/ Hiding ‘Move’ Lines” on page 4-16.

Enable if you wish to delete wires that are connected to components being deleted; to delete wires that are connected to components being deleted, leave this box unchecked.

1. In the **Selection Rectangle** box, select either **Intersecting** or **Fully Enclosed**. See “Setting Dragging Selection Options” on page 4-14 for details.

2. In the **Mouse Wheel Behavior** box select one of:
  - **Zoom workspace** — mouse wheel will let you zoom in and out on workspace.
  - **Scroll workspace** — mouse wheel will let you scroll up and down the page.
3. In the **Autowire** box select the desired options to control the degree of automation used in wiring. For details, see “4.5.6 Setting Wiring Preferences” on page 4-26.

## 3.4.2 Using the Sheet Properties Dialog Box

The **Sheet Properties** dialog box is used to set up the preferences for each sheet. These preferences are saved with the circuit file so that if the circuit is opened on another computer, it will use the same settings.

**Note** For personal (user) preferences, see “3.4.1 Using the Preferences Dialog Box” on page 3-20.

➤ To set sheet preferences:

1. Select **Options /Sheet Properties**.

*Or*

Right-click on a blank area of the workspace and choose **Properties** from the pop-up menu that appears. Do not select any elements (for example, components, wires) on the workspace, or the properties dialog box for the selected element will display instead.

The **Sheet Properties** dialog box appears, offering you the following tabs:

- **Circuit** — where you set the color scheme and the display properties of workspace text
  - **Workspace** — where you set the sheet size and properties
  - **Wiring** — where you set the wire and bus options
  - **Font** — where you select the font, font size and style for text elements on the circuit
  - **PCB** — where you set up options for your printed circuit board
  - **Visibility** — where you enable and disable custom annotation layers.
2. Select the desired tab.
  3. Set the desired customization options. The specific options and settings available in the tabs are described in the following sections of this chapter.
  4. The **Save as Default** checkbox is normally enabled. If you do *not* wish to have the settings saved as the default, disable this checkbox. Default settings are those used when you create new circuits (**File/New**).
  5. Click **OK** to save your changes. (If you wish to apply the changes without closing the dialog, click **Apply**).

### 3.4.2.1 Sheet Properties - Circuit Tab

The options on this tab control the way your circuit and its components appear on the workspace, and the level of detail which appears. Multisim comes with several color schemes that affect the circuit window background color, wire color, and component color. You can also develop your own color scheme to meet your individual needs.

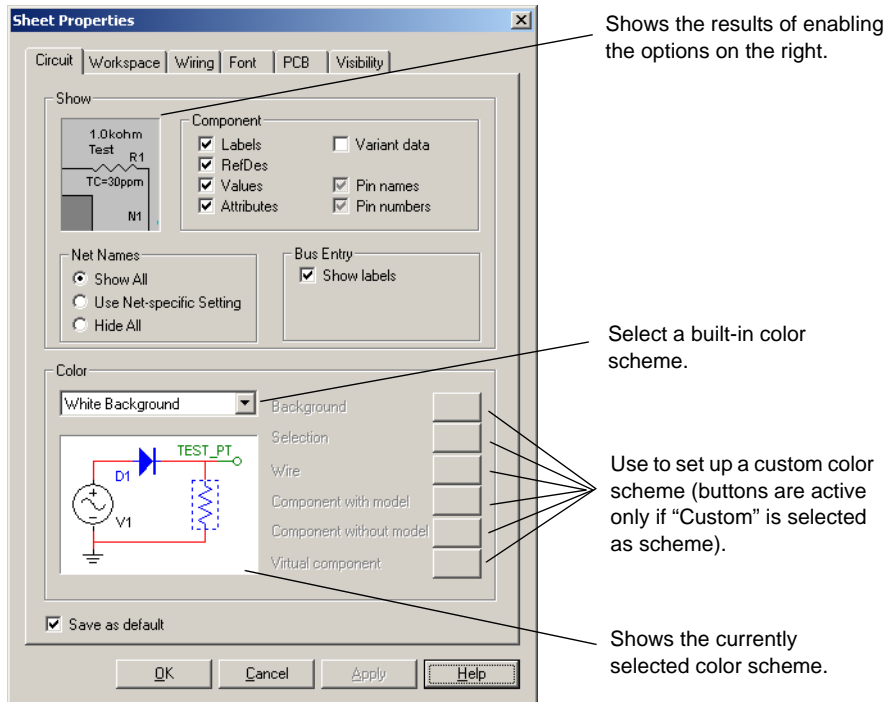

1. In the **Component** box, enable those items you want shown on the workspace. You can override your choices for a particular component, as described in “5.1.1 Displaying Identifying Information about a Placed Component” on page 5-2.
  - **Pin names** checkbox — when fully checked, shows all pin names; when not checked, shows no pin names; when grey checked, shows pin names for those components whose default behavior is to show them.
  - **Pin numbers** checkbox — when fully checked, shows all pin numbers; when not checked, shows no pin numbers; when grey checked, shows pin numbers for those components whose default behavior is to show them.

**Note** Pin names and numbers are made visible as details above; checking and un-checking in the **Visibility** tab of the **Design Toolbox** has no effect.

2. In the **Net Names** box, select how net names will be shown:
  - **Show All** — check to display all net names on the workspace.
  - **Use Net-specific Setting** — check to show net names as set in the **Net** dialog box. For details, see “4.9.2 Modifying Net Names” on page 4-35.
  - **Hide All** — check to hide all net names on the workspace.
3. In the **Color** box:
  - To use one of the built-in color schemes :
    - Choose the scheme from the drop-down list.
    - A representation of the scheme’s settings appears in the preview box below the list.
  - To create a custom color scheme:
    - Choose **Custom** from the drop-down list.
    - Click on the color bar next to any item. A **Color** selector dialog box appears.
    - Click on the color you want to use for that item and click **OK**.
    - You are returned to the **Sheet Properties** dialog box.
    - The results of your choice appear in the preview box.
    - Repeat until all your color settings are made.

### 3.4.2.2 Sheet Properties - Workspace Tab

The options on this tab determine the appearance and behavior of the circuit window.

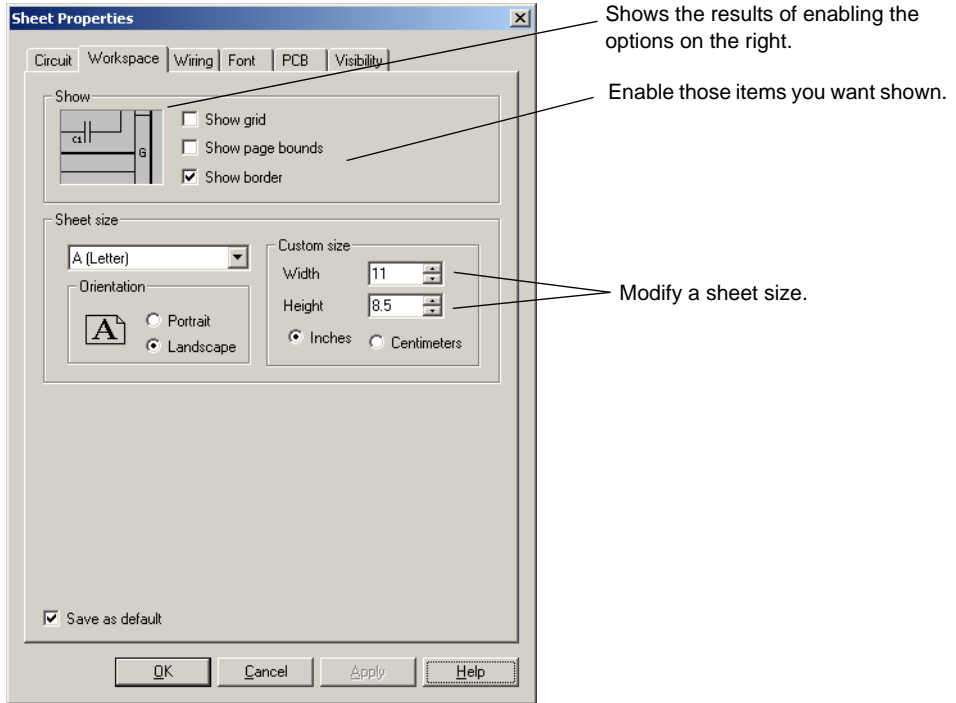

Multisim comes with the standard sheet sizes that you can use for capturing your circuit. You can modify any of the settings of these sizes to make your own custom sheet.



### 3.4.2.3 Sheet Properties - Wiring Tab

The options on this tab control the wire width, bus width and bus wiring mode options.

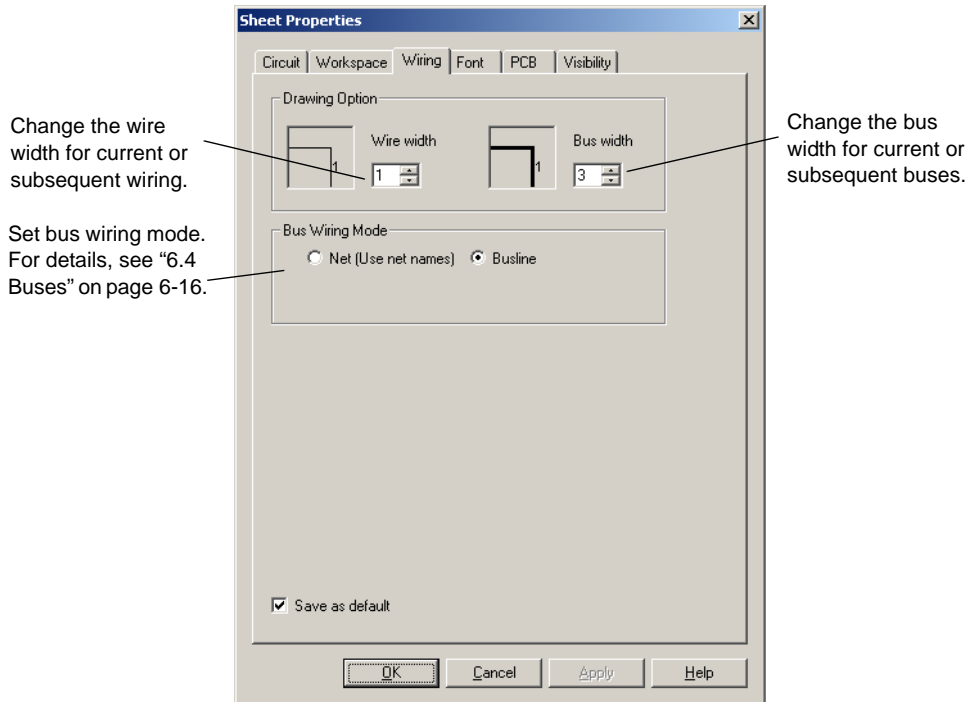

### 3.4.2.4 Sheet Properties - Font Tab

Use this tab to set the font parameters for all elements in the workspace containing text.

Specify the font, style and size of labels and names on your circuit.

Displays a sample using the selected font settings.

Specify the text element to change to the selected font.

Changes the font for all instances of the elements selected in "Change All".

To change font for a specific selection, right-click on the desired, part, etc, select Font from the pop-up that appears and click on Selection.

**Caution** Changing to larger fonts may cause labels to collide or exceed boundaries.

- To change the font for any text element of the circuit:
1. Select the font, font style and font size for the desired elements.
  2. Select the elements you want to change from the following options in the **Change All** section of the tab:

Font Option	Description
Component RefDes	The component's unique identification (Reference Designator). For example, R22.
Component Values and Labels	The value being used by the component and identified in the Values tab of the component's properties dialog box. For details on viewing and modifying this value see "5.1.2 Viewing a Placed Component's Value/Model" on page 5-3. The Component label assigned by Multisim and identified in the Label tab of the component's properties dialog box. For details on changing this label see "4.9.1 Modifying Component Labels and Attributes" on page 4-34.
Component Attributes	Descriptive information you add to specific components using the component's properties dialog box. For details see "4.9.1 Modifying Component Labels and Attributes" on page 4-34.
Pin Numbers	The number automatically assigned to a pin when it is placed on your circuit.
Pin Names	The logical name for a pin, for example, GND (for ground).
Net Names	The name automatically assigned to a net when it is placed on your circuit. For details on changing this name see "4.9.2 Modifying Net Names" on page 4-35.
Schematic Text	Notes that you add to your circuit using the Place/Text command. For details see "4.9.4 Adding Miscellaneous Text" on page 4-39.
Comments and Probes	Text found in comments that you add to the circuit from the Place/Comment command. Also for text found in probes that placed from the Instrument toolbar. For details, see "4.9.5 Adding a Comment" on page 4-40 and "10.15 Measurement Probe" on page 10-40.
Busline Name	The name that you assign to buslines. For details, see "6.4 Buses" on page 6-16.

### 3.4.2.5 Sheet Properties - PCB Tab

This tab is used to set options used when exporting data for PCB layout.

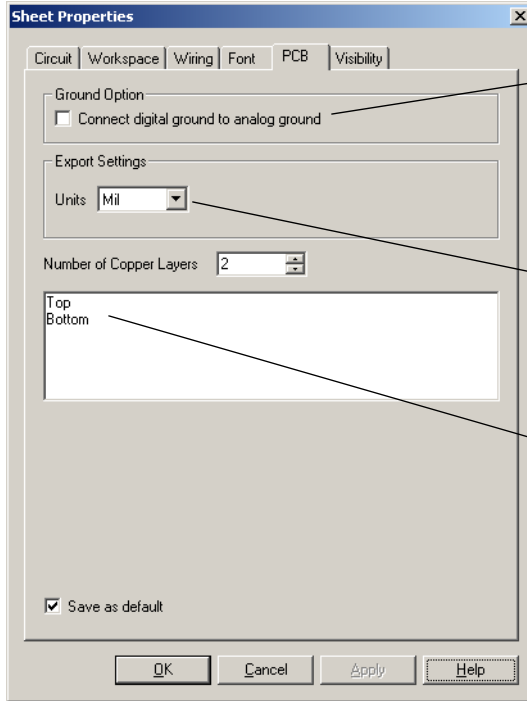

Select this option to make digital and analog ground the same when exporting to PCB layout packages.

Select units to use during export to PCB layout.

As you increase the number of copper layers, the number of copper layers (inner) increases. This setting is used by Ultiboard to determine the default board setup.

### 3.4.2.6 Sheet Properties - Visibility Tab

This tab lets you add the custom annotation layers that are available in Multisim.

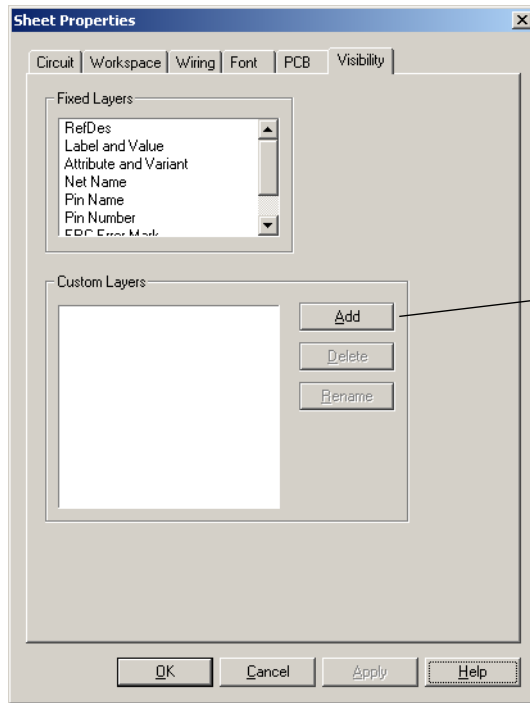

Click to add custom annotation layers to the schematic. You can show/hide these layers from the Visibility tab in the Design Toolbox. For details, see “3.5.1 Visibility Tab” on page 3-34

For details on annotation layers, refer to “3.5.1 Visibility Tab” on page 3-34.

## 3.5 Design Toolbox

The **Design Toolbox** is used to manage various elements in the schematic.

**Note** For a description of the **Project View** tab, see “6.6 Project Management and Version Control” on page 6-47.

### 3.5.1 Visibility Tab

The **Visibility** tab lets you choose which layers to display on the current sheet on the workspace.

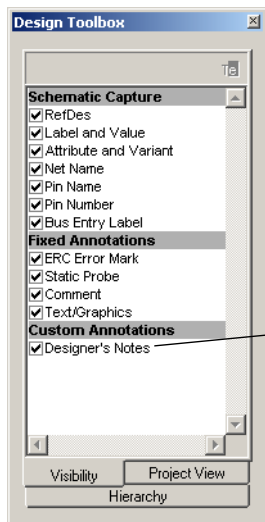

Custom annotation layer added via the Visibility tab in the Sheet Properties dialog box.

The **Schematic Capture** layers consist of:

- **RefDes** — this layer contains the Reference Designators for all elements on the workspace, for example, R1, U2A.
- **Label and Value** — this layer contains the label entered in the component’s properties dialog box in the **Label** field in the **Label** tab. It also contains the component’s value, for example, 1 kohm. See “5.1 Placed Component Properties” on page 5-2 for details.
- **Attribute and Variant** — this layer contains the attribute information entered in the component’s properties dialog box in the **Attributes** fields in the **Label** tab. It also includes the Variant Status. For details, see “6.5 Variants” on page 6-34.
- **Net Name** — this layer contains the netnames.

- **Pin Name** — this layer contains the pin names, for example, “1Q” in a J-K flip-flop.
- **Pin Number** — this layer contains the pin numbers.
- **Bus Entry Label** — this layer contains the labels that appear at the point where a wire enters a bus, for example, “Ln 1”.

The **Fixed Annotations** layers consist of:

- **ERC Error Mark** — this layer contains the marks that are placed on the schematic that indicate ERC error points. See “5.4 Electrical Rules Checking” on page 5-34 for details.
- **Static Probe** — this layer contains the static measurement probes that can be placed on the schematic. Refer to “10.15 Measurement Probe” on page 10-40 for details.
- **Comment** — this layer contains any comments that you “pin” to the workspace. Refer to “4.9.5 Adding a Comment” on page 4-40 for details.
- **Text/Graphics** — this layer contains any graphic elements that you place on the workspace.

**Custom Annotations** layers can be added from the **Sheet Properties** dialog box. For details, see “3.4.2.6 Sheet Properties - Visibility Tab” on page 3-33.

- To hide a layer, disable the layer’s checkbox.
- To show a hidden layer, enable the layer’s checkbox.

## 3.5.2 Hierarchy Tab

The **Hierarchy** tab contains a tree that shows the files in the design that you have open.

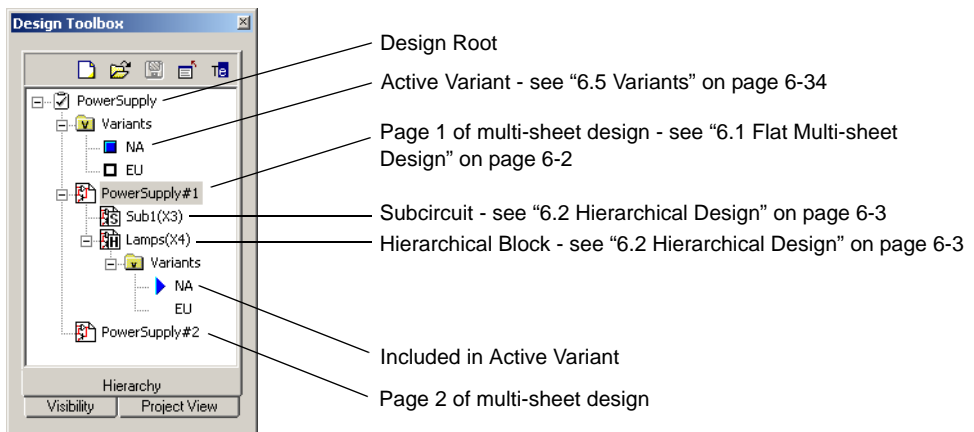

## Pop-up Menus

- To view context-sensitive menus in the **Hierarchy** tab:
  1. Right-click on an item. Depending on the item, different context-sensitive menus appear.
  2. From the Design Root you can select:
    - **Close** — to close the entire design.
    - **Save** — to save the design.
  3. From an active or in-active variant that branches from the Design Root, you can select:
    - **Set Variant Active** — to set the active variant. A blue box displays beside the active variant. For details, see “6.5.2.3 Setting the Active Variant for Simulation” on page 6-44.
    - **Variant Manager** — to display the **Variant Manager** dialog box. For details, see “6.5.1 Setting Up Variants” on page 6-34.
  4. From a page of a multi-sheet design (in this example, PowerSupply#1), you can select:
    - **Open Window** — to open the page on the workspace.
    - **Close Window** — to close the page.
    - **Rename Page** — to change the multi-page’s name.
  5. From a subcircuit, you can select:
    - **Open Window** — to open the subcircuit on the workspace.
    - **Close Window** — to close the subcircuit.
    - **Rename Subcircuit** — to change the subcircuit’s name.
  6. From a Hierarchical Block, you can select:
    - **Open Window** — to open the Hierarchical Block on the workspace.
    - **Close Window** — to close the Hierarchical Block.
    - **Map Variants** — to display the Hierarchical Block’s properties dialog box, where you can assign its variant status. For details, see “6.5.2.1 Assigning Variant Status to Components” on page 6-38.
  7. From a variant that branches from a Hierarchical Block, you can select:
    - **Variant Manager** — to display the **Variant Manager** dialog box. For details, see “6.5.1 Setting Up Variants” on page 6-34.
    - **Exclude from Active Variant** — to exclude this variant from the active variant. If desired, you can exclude all variants in a Hierarchical Block from the Active Variant.
    - **Include in Active Variant** — to include this variant in the active variant. A blue triangle appears beside the included variant. You can only include one variant at a time in the Active Variant.



## 3.6 Customizing the Interface

The Multisim user interface is highly customizable. Separate customizations may be applied whenever each different type of sheet becomes active. For example, the toolbars and docking windows may be re-configured as you move from a circuit sheet to a description sheet.

Toolbars may be docked in various positions and orientations. The contents of the toolbars may be customized. New toolbars may be created. The menu system is fully customizable, including all pop-up menus for the various object types.

As well, the keyboard shortcut system is customizable. This allows for any keys or key combinations to be assigned to any command that may be placed in a menu or on a toolbar.

➤ To customize the interface:

1. Select **Options/Customize User Interface**.
2. Make changes in the **Customize** dialog's tabs as detailed in the following sections:
  - “3.6.1 Commands tab” on page 3-38
  - “3.6.2 Toolbars tab” on page 3-39
  - “3.6.3 Keyboard tab” on page 3-40
  - “3.6.4 Menu tab” on page 3-41
  - “3.6.5 Options tab” on page 3-42
  - “3.6.6 Customization Pop-up Menus” on page 3-42
  - “3.6.7 Other Customization Options” on page 3-43.

## 3.6.1 Commands tab

The **Commands** tab in the **Customize** dialog box is used to add commands to menus and toolbars.

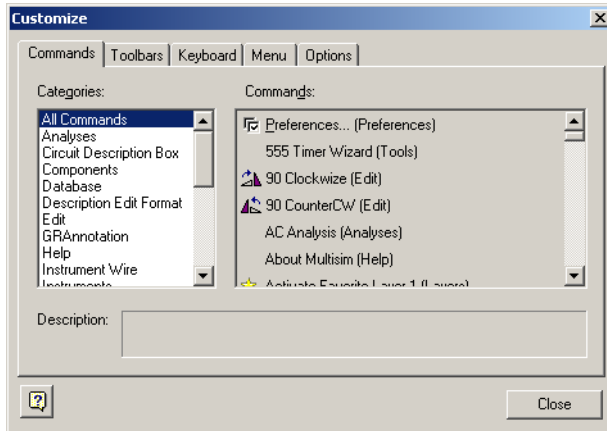

- To add a command to a menu or toolbar:
  1. Drag it from the **Commands** list to the desired menu or toolbar. When a command is selected in the **Command** list, its description is displayed in the **Description** field.
  2. If you do not see the command that you require, click on another selection in the **Categories** list to display more commands.
  3. If you wish to add a button to a toolbar that is not showing, click on the **Toolbars** tab and click in the checkbox beside the desired toolbar to make it visible.
  4. Click **Close** when customizations are complete.
- To remove a command from a menu or toolbar, right-click on it and select **Delete** from the pop-up that appears. The **Customize** dialog box must be open when you do this.
- To change the position of a command that is in a menu or toolbar, drag it to its new location. The **Customize** dialog box must be open when you do this.

## 3.6.2 Toolbars tab

The **Toolbars** tab in the **Customize** dialog box is used to show or hide toolbars, and to add new custom toolbars.

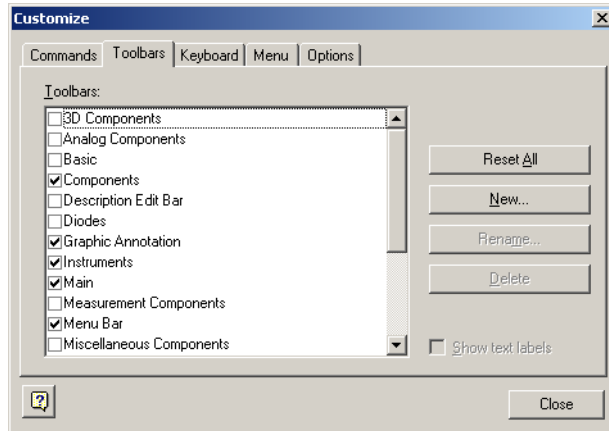

➤ To use the features in this tab:

1. To display a toolbar, switch on the checkbox beside the desired toolbar in the **Toolbars** list.
2. Switch off a checkbox to hide a toolbar.

**Note** You cannot switch off the **Menu** bar.

3. The buttons in this tab function as follows:

- **Reset All**—displays the **Reset Toolbars** dialog box, where you select whether to reset the currently selected toolbars, or all toolbars. You are prompted to select the configuration file you wish to use, for example, “default.ewcfg”.
- **New**—displays the **Toolbar Name** dialog box, where you enter the name for a new toolbar. When you click **OK**, a new toolbar with the name that you entered is created. Follow the steps in “3.6.1 Commands tab” on page 3-38 to add buttons to the toolbar.
- **Rename**—use to rename a toolbar that you have created yourself. You cannot rename toolbars that are included in Multisim by default. for example, **Components**, **Menu Bar**.
- **Delete**—use to delete the selected toolbar. You cannot delete toolbars that are included in Multisim by default. for example, **Components**, **Menu Bar**.
- **Show text labels**—select this checkbox to show the text labels (for example, “Save”) in the toolbar, along with the command’s icon.

4. Click **Close** when customizations are complete.

### 3.6.3 Keyboard tab

The **Keyboard** tab is used to set up keyboard shortcuts.

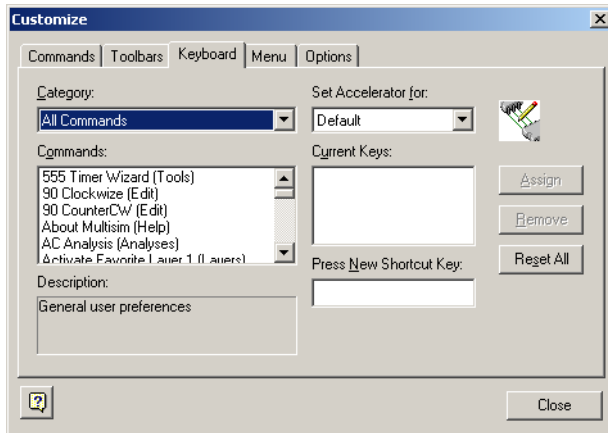

- To set up keyboard shortcuts:
  1. Choose a menu from the **Category** drop-down list and the desired command from the **Commands** drop-down list. If a shortcut is already assigned, it appears in the **Current Keys** field.
  2. Enter a new shortcut in the **Press New Shortcut Key** field.
  3. Click **Close** when customizations are complete.

## 3.6.4 Menu tab

The **Menu** tab is used to modify the various context-sensitive menus that appear when you right-click from various locations in Multisim.

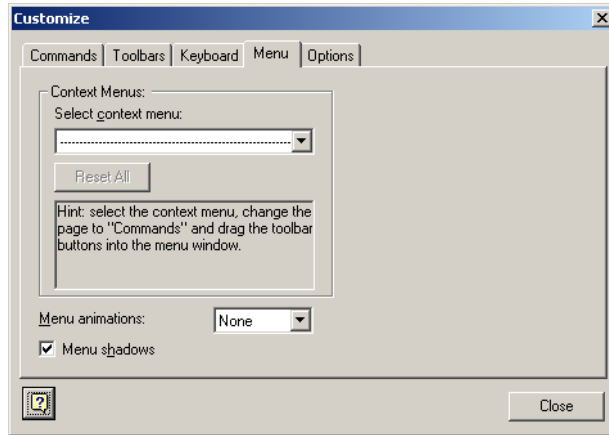

- To display the desired menu:
  1. Select the desired menu set from the **Select Context Menu** drop-down list.
  2. Right-click on the menu that appears and edit as desired.
  3. Select the desired menu effects using the **Menu animations** drop-down list and the **Menu shadows** checkbox.

## 3.6.5 Options tab

The **Options** tab in the **Customize** dialog box is used to set up toolbar and menu options.

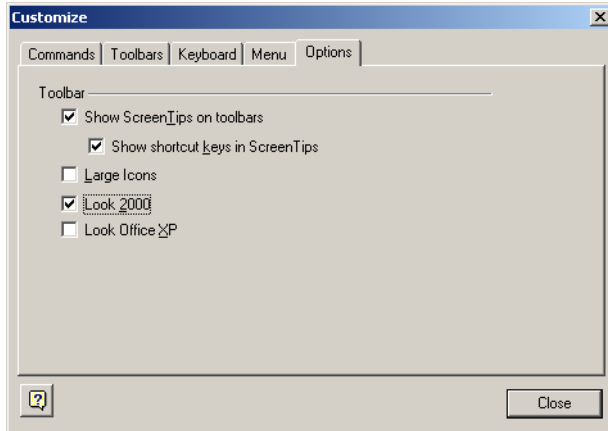

- To set up menu and toolbar options, switch the checkboxes on or off as desired.

## 3.6.6 Customization Pop-up Menu

To customize the appearance of toolbar buttons and menu items, a pop-up menu is available when the **Customize** dialog box is open.

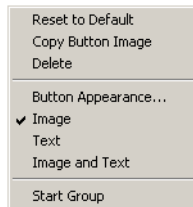

- To display the above pop-up:
  1. Be sure you have the **Customize** dialog box open.
  2. Right-click on either a menu item or toolbar and select the desired option.

3. When you select **Button Appearance**, the **Button Appearance** dialog box appears, where you can change the appearance of the selected toolbar button.

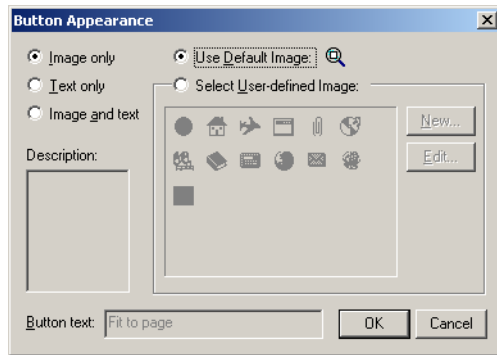

### 3.6.7 Other Customization Options

The Multisim user interface is highly customizable. Separate customizations may be applied whenever a different type of sheet becomes active. For example, the toolbars and docking windows may be re-configured as you move from a circuit sheet to a description edit sheet.

Toolbars may be docked in various positions and orientations. The contents of the toolbars may be customized. New toolbars may be created. The menu system is fully customizable, including all pop-up menu for the various object types. You can also customize the interface by showing or hiding, dragging to a new location and, optionally, resizing any of toolbars.

These changes apply to all circuits you are working with. Moved or resized items will return to that location and size when Multisim is next opened.

# Chapter 4

## Schematic Capture - Basics

This chapter describes the basic functions involved in creating a circuit in the circuit window. It explains the fundamental steps in circuit creation, but is not intended to describe all the potential aspects of circuit design. For example, you should look to other chapters for details on the component database and instructions on editing components.



Some of the features described in this chapter may not be available in your edition of Multisim 9. Such features have an icon in the column next to their description. Refer to the release notes for a list of the features in your edition.

The following are described in this chapter.

<b>Subject</b>	<b>Page No.</b>
<b>Introduction to Schematic Capture</b>	4-3
<b>Working with Multiple Circuit Windows</b>	4-3
<b>Selecting Components from the Database</b>	4-3
<b>Placing Components</b>	4-4
Using the place component browser	4-4
Placing Virtual Components	4-9
Using the In Use List	4-13
Selecting Placed Components	4-13
Moving a Placed Component	4-15
Copying a Placed Component	4-16
Replacing a Placed Component	4-17
Controlling Component Color	4-18



<b>Subject</b>	<b>Page No.</b>
<b>Wiring Components</b>	4-18
Wiring Components Automatically	4-19
Wiring Components Manually	4-22
Combining Automatic and Manual Wiring	4-23
Marking Pins for No Connection	4-23
Placing Wires Directly Onto Workspace	4-26
Setting Wiring Preferences	4-26
Modifying the Wire Path	4-27
Controlling Wire Color	4-27
Moving a Wire	4-28
Virtual Wiring	4-28
<b>Manually Adding a Junction (Connector)</b>	4-29
<b>Rotating/Flipping Placed Components</b>	4-30
<b>Finding Components in Your Circuit</b>	4-32
<b>Labeling</b>	4-33
Modifying Component Labels and Attributes	4-34
Modifying Net Names	4-35
Adding a Title Block	4-36
Adding Miscellaneous Text	4-39
Adding a Comment	4-40
Graphic Annotation	4-43
Capturing Screen Area	4-45
<b>Circuit Description Box</b>	4-47
Formatting the Circuit Description Box	4-47
Scrolling with Events During Simulation	4-51
Description Edit Bar	4-57
<b>Linking a Form to a Circuit</b>	4-59
Creating Forms	4-59
Setting Form Submission Options	4-60
Completing Forms	4-61
<b>Printing the Circuit</b>	4-62

## 4.1 Introduction to Schematic Capture

Schematic capture is the first stage in developing your circuit. In this stage you choose the components you want to use, place them on the circuit window in the desired position and orientation, wire them together, and otherwise prepare your design. Multisim lets you modify component properties, orient your circuit on a grid, add text and a title block, add subcircuits and buses, and control the color of the circuit window background, components and wires.

**Note** For details on setting up your workspace, refer to “3.4 Setting Schematic Capture Preferences” on page 3-20.

## 4.2 Working with Multiple Circuit Windows

You can open as many circuits as you want at the same time. Each circuit appears in its own circuit window. The active circuit window is, as in other Windows applications, the window with the highlighted title bar. You can use the Window menu to move from circuit window to circuit window or just click on the tab at the bottom of the workspace for the circuit you want to see.

Each window is distinct, and can have its own preferences settings, set of components and so on. You can copy, but not move, a component or instrument from one circuit window to another.

## 4.3 Selecting Components from the Database

The first step in schematic capture is placing the appropriate components on your circuit window.

You can use the following methods to locate a component in the database:

- use the **Component** toolbar to browse through all the component groups, as explained in “4.4.1 Using the place component browser” on page 4-4
- search a specific component group/family of the database, as explained in “7.2.2 Searching for Components” on page 7-4.

**Note** There are multiple “levels” of the component database as discussed in “7.1.1 Database Levels” on page 7-2.

The first of these choices is normally used. Each button on the **Component** toolbar corresponds to a group of components with similar functionality. Clicking one of these buttons opens the place component browser (i.e., the **Select a Component** dialog box) with the contents of that button’s group displayed.

Multisim provides the unique concept of virtual components. Virtual components have a symbol and a model, but no footprint and hence are not “real” in the sense that they cannot be purchased. They are included for simulation flexibility. Virtual component families are color coded green in the **Select a Component** dialog box.

## 4.4 Placing Components

The component browser is used to select parts from the three databases and place them on a circuit. It is designed to make it fast and easy to find the part you are looking for amongst the more than 17,000 available.

Parts are organized by database, group, and family (for example, Master Database, Digital Group, TTL Family). Filters are provided as appropriate to narrow lists based on value range and tolerance where applicable. Type-ahead allows you to type a few characters to jump to the component you are looking for. Search capabilities allow you to find parts using generalized wildcard searches throughout all the databases.

### 4.4.1 Using the place component browser

By default, the **Components** toolbar is enabled. If it has been turned off, select **View/Toolbars/Components** or right-click in the menu area and select **Place Component** from the pop-up that appears.

**Note** This section describes the placement of “real” components. Use the **Virtual** toolbar to place “virtual” components, as explained in “4.4.2 Placing Virtual Components” on page 4-9.

- To choose and place a component.

1. Click on the desired group in the **Component** toolbar, for example, **Basic**. The **Select a Component** dialog box appears with the selected component group displayed.

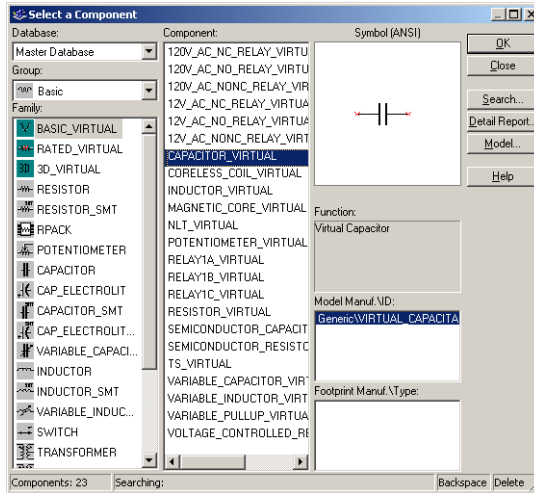

Alternatively, you can display the **Select a Component** dialog box by choosing **Place/Component** and selecting the desired group from the **Group** drop-down list.

**Note** The **Select a Component** browser is also referred to as the place component browser.

**Note** The default database that displays in the browser is the **Master Database**. If you wish to select a component from either the **Corporate Database** or **User Database**, you must select that database from the **Database** drop-down list before selecting a component. Once changed, the database will remain as selected for subsequent part placements.

2. Click on the desired component family in the **Family** list.
3. Click on the desired component in the **Component** list.

**Tip** To make your scroll through the **Component** list faster, simply type the first few characters of the component's name. As you type, matches are displayed in the top of the **Component** list. If you make a mistake, you can use the **BACKSPACE** key to remove one character at a time, or the **DELETE** key to remove all of the characters that you typed.

**Note** Virtual components are identified by a green icon in the **Family** column. You can also place virtual components by using the **Virtual Toolbar**. For details, see “4.4.2 Placing Virtual Components” on page 4-9.

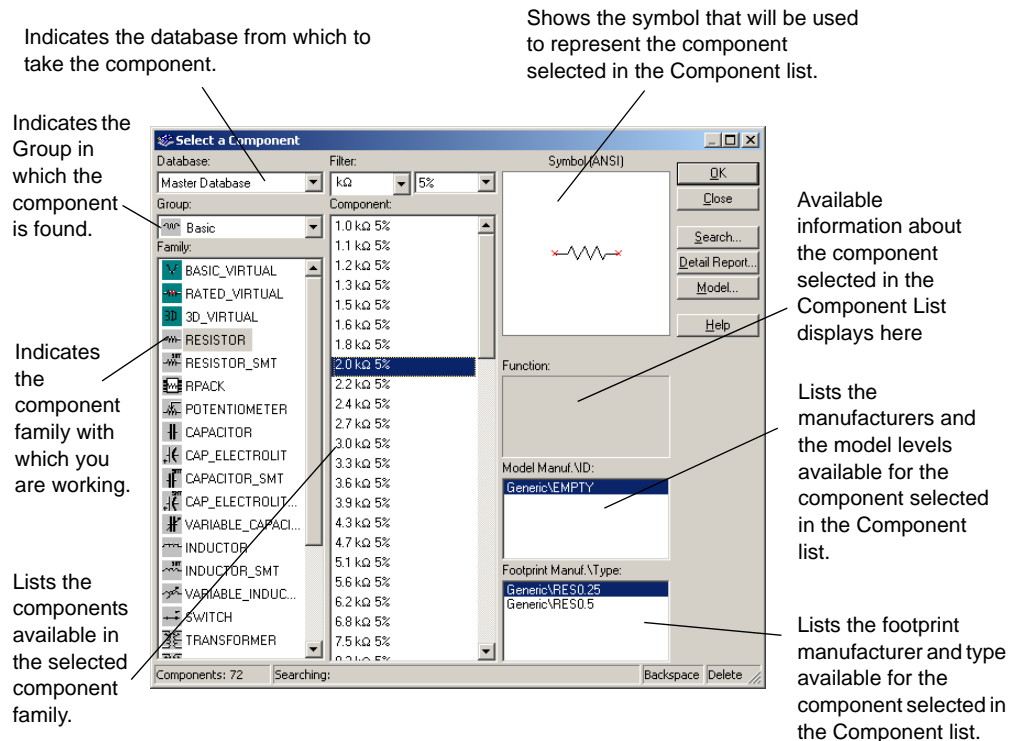

4. To confirm that this is the component you want to place, click **OK**. (To cancel placing the component, click **Close**). The browser closes and the cursor on the circuit window changes to a ghost image of the component you wish to place. This indicates that the component is ready to be placed.

**Note** If you are placing a component whose package includes multiple sections (for example, four separate gates, as in the above example), a dialog box displays, where you specify which of the sections you want to place. For a more detailed description of the dialog’s functionality, refer to “4.4.1.1 Multisection Components” on page 4-7.

5. Move your cursor to the location where you want the component placed. The workspace automatically scrolls if you move your cursor to the edges of the workspace.

**Note** See also, “4.4.1.2 Rotating/flipping a part during placement” on page 4-9.

6. Click on the circuit window where you want the component placed. The component's symbol and labels appear (unless you have specified that they are not to be displayed, as explained in "5.1.1 Displaying Identifying Information about a Placed Component" on page 5-2), as well as a unique RefDes made up of a letter and number. The letter represents the type of component and the number is a sequential number that indicates the order in which the components were originally placed. For example, the first digital component has the RefDes "U1", the next is "U2", the first inductor has the RefDes "L1", and so on.

**Note** If the component you place is a virtual component, it is a different color from real components. This color is set in the **Sheet Properties** dialog box, as explained in "3.4.2.1 Sheet Properties - Circuit Tab" on page 3-26.

**Tip** Some components, like resistors and capacitors will have **Filter** fields at the top of the **Component** list, to make part selection faster.

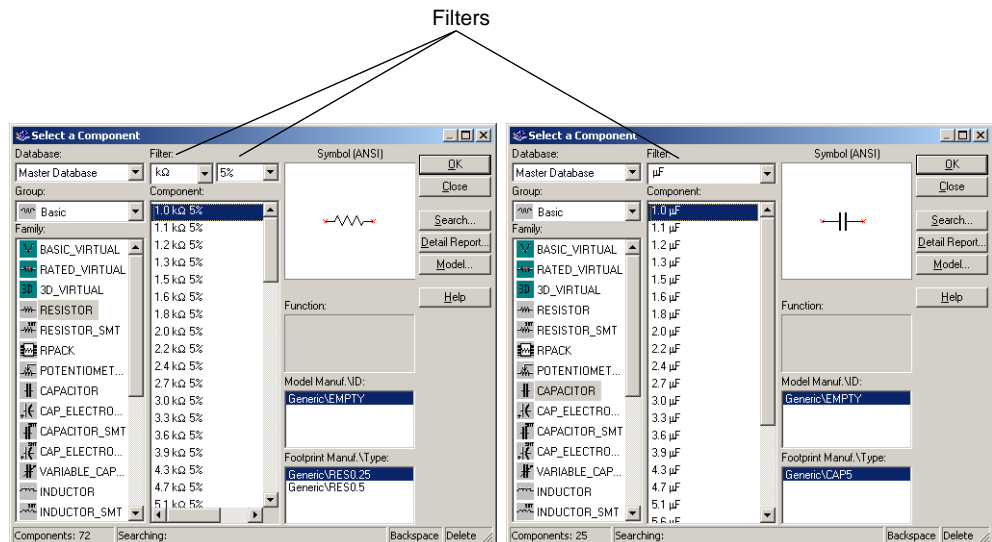

#### 4.4.1.1 Multisection Components

Certain non-virtual parts do not have a one-to-one correspondence with a footprint. Rather, several circuit components may correspond to a single physical package. An example is a quad 2-input NAND gate such as the Texas Instruments 7400N. For this example, up to four components on a schematic diagram may correspond to a single part for the purposes of PCB layout.

To place a multi-section part, you select the physical part from the component browser. Immediately prior to placing the component, a section chooser pops up that lists parts that have free sections, or allows you to start a new part. You must select one of these sections for placement. Once placed, optimizing facilities are provided to enable multi-section parts to be efficiently packed into chips, and a spare gate report is available to show sections not used on multi-section parts in the circuit.

Refer to the following example for details.

➤ To place a multi-section part:

1. Select **Place/Component** and navigate to the desired **Group, Family and Component**.
2. Click **OK**. If this is the first multi-section component of this type (e.g., 7400N) being placed on the circuit, a dialog box appears as follows:

Click to place section A of the component.



If there are other multi-section components placed the **Select Part** dialog box will be similar to the following:

Darker text indicates available sections for placement. Click on an available section to place it.

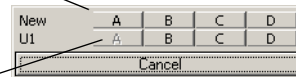

Greyed-out text indicates this section has already been placed.

**Note** It is a good idea to place all the sections of a multi-section device (U1 in this example) before going to a new multi-section device of the same type.

**Note** Only instances of the same component type are shown as available to place. In the above example, U1 and “New” are both quad 2-input 7400N ICs. If there are other quad 2-input NAND devices in the circuit, for example 74LS01N, they will not be displayed.

3. Click on any available section. The dialog box closes and a ghost image of the device is attached to your cursor.
4. Click to place the device in the desired location.

5. If you selected either **Continuous placement for multi-section part only** or **Continuous placement** in the **Parts** tab of the **Preferences** dialog box, the dialog box re-appears. Continue placing parts from this dialog. When finished, press ESC to exit.
  6. If you selected **Place Single Component** in the **Parts** tab of the **Preferences** dialog box, the dialog box does not re-appear after placing a component.
- Note** Settings for placing components with multiple devices are found in the **Parts** tab of the **Preferences** dialog box. For details, see “3.4.1.3 Preferences - Parts Tab” on page 3-23.

### 4.4.1.2 Rotating/flipping a part during placement

- To rotate or flip a part during placement:
  1. Select a part as detailed in “4.4.1 Using the place component browser” on page 4-4.
  2. As you are dragging the “ghost” image of the part that you are placing, press one of the following key combinations:
    - CTRL-R — rotates the component 90 degrees clockwise.
    - CTRL-SHIFT-R — rotates the component 90 degrees counter-clockwise.
    - ALT-X — flips the component horizontally.
    - ALT-Y — flips the component vertically.

### 4.4.1.3 Other buttons

- To display the **Search Component** dialog box, click the **Search** button. For details, see “7.2.2 Searching for Components” on page 7-4.
- To display the **Component Detail Report** dialog box, click the **Detail Report** button. For details, see “13.2 Component Detail Report” on page 13-5.
- To display the **Model Data Report** dialog box, click the **Model** button. For details, see “13.6 Model Data Report” on page 13-11.

## 4.4.2 Placing Virtual Components

Use the **Virtual** toolbar to place virtual components on your workspace.











**Note** This toolbar is not displayed by default. To display it, select **View/Toolbars/Virtual**.



➤ To place a virtual component:

1. Click on the desired button in the **Virtual** toolbar.

Button	Description
	<b>Show Power Source Components</b> button. Displays the <b>Power Source Components</b> toolbar, which contains buttons that let you place different virtual Power Source components.
	<b>Show Signal Source Components</b> button. Displays the <b>Signal Source Components</b> toolbar, which contains buttons that let you place different virtual Signal Source components.
	<b>Show Basic Components</b> button. Displays the <b>Basic Components</b> toolbar, which contains buttons that let you place different virtual Basic components.
	<b>Show Diode Components</b> button. Displays the <b>Diodes Components</b> toolbar, which contains buttons that let you place different virtual diodes.
	<b>Show Transistor Components</b> button. Displays the <b>Transistor Components</b> toolbar, which contains buttons that let you place different virtual transistors.
	<b>Show Analog Components Bar</b> button. Displays the <b>Analog Components</b> toolbar, which contains buttons that let you place different virtual Analog components.
	<b>Show Miscellaneous Components Bar</b> button. Displays the <b>Miscellaneous Components</b> toolbar, which contains buttons that let you place miscellaneous virtual components.
	<b>Show Measurement Components Bar</b> button. Displays the <b>Measurement Components</b> toolbar, which contains buttons that let you place different virtual Measurement components.

**Note** For details on the various toolbars that appear when buttons on the **Virtual** toolbar are pressed, see “4.4.2.1 Virtual component toolbars” on page 4-10.

2. From the toolbar that displays, click on the desired virtual component. The cursor changes to a “ghost” image of the component you wish to place.
3. Click on the workspace in the desired location to place the virtual component.

### 4.4.2.1 Virtual component toolbars

This section describes the virtual components that can be placed from the various virtual component toolbars that are accessed by pressing the corresponding button on the **Virtual** toolbar. For details see, “4.4.2 Placing Virtual Components” on page 4-9.

## Power Source Components toolbar



The buttons (from left to right) in the **Power Source Components** toolbar place the following virtual components: AC Power Source; DC Power Source; Digital Ground; Ground; 3 Phase Voltage Source Delta; 3 Phase Voltage Source Wye; VCC Supply; VDD Supply; VEE Supply; VSS Supply.

## Signal Source Components



The buttons (from left to right) in the **Signal Source Components** toolbar place the following virtual components: AC Current Source; AC Voltage Source; AM Source; Clock Current Source; Clock Voltage Source; DC Current Source; Exponential Current Source; Exponential Voltage Source; FM Current Source; FM Voltage Source; PWL Linear Current; PWL Linear Voltage; Pulse Current Source; Pulse Voltage Source; White Noise Source.

## Basic Components toolbar

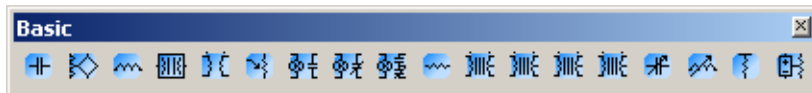

The buttons (from left to right) in the **Basic** toolbar place the following virtual components: capacitor; coreless coil; inductor; magnetic core coil; non-linear transformer; potentiometer; normally open relay; normally closed relay; combination relay; resistor; audio transformer; miscellaneous transformer; power transformer; transformer; variable capacitor; variable inductor; pullup resistor; voltage controlled resistor.

## Diodes toolbar



The buttons (from left to right) in the **Diodes** toolbar place the following virtual components: diode; zener diode.

## Transistor Components toolbar



The buttons (from left to right) in the **Transistor Components** toolbar place the following virtual components: BJT NPN 4T; BJT NPN; BJT PNP 4T; BJT PNP; GaAsFET N; GaAsFET P; JFET N; JFET P; several enhancement and depletion mode NMOSFETs and PMOSFETs.

## Analog Components toolbar



The buttons (from left to right) in the **Analog Components** toolbar place the following virtual components: Comparator; 3 Terminal Opamp; 5 Terminal Opamp.

## Miscellaneous Components toolbar

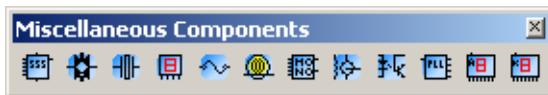

The buttons (from left to right) in the **Miscellaneous Components** toolbar place the following virtual components: 555 Timer; Analog Switch; Crystal; DCD Hex; Current Rated Fuse; Lamp; Monostable; Motor; Optocoupler; Phase Locked Loop; 7 Segment Display Common Anode; 7 Segment Display Common Cathode.

## Measurement Components toolbar



The buttons (from left to right) in the **Measurement Components** toolbar place the following virtual components: Ammeter (4 configurations); Digital Probe (5 colors); Voltmeter (4 configurations).

### 4.4.3 Using the In Use List

Each time you place a component, it is added to the **In Use List** for easy re-use. To place another instance of any currently placed component, simply select it from the list. The copied component appears at the top of your circuit window—you can move it to any location you like.

### 4.4.4 Selecting Placed Components

You can select a component that has been placed on the workspace by either clicking on it or dragging the mouse to make a selection.

- To select a component by clicking the mouse, left-click on its center.



**Tip** If you wish to select a component's label or other text, but not the entire component, do not click on the center of the component — click directly on the text.

- To select a component by dragging the mouse:
  1. Click and hold the left mouse button and drag the cursor to form a selection rectangle on the workspace that contains the component to be selected.

You can set whether you must enclose all or part of component in the selection rectangle. See “Setting Dragging Selection Options” on page 4-14.

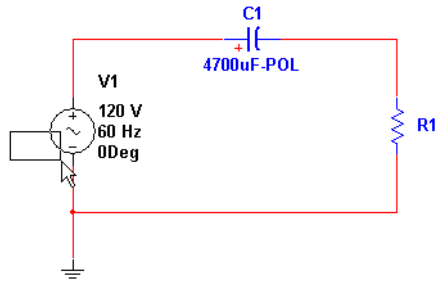

2. Release the mouse.

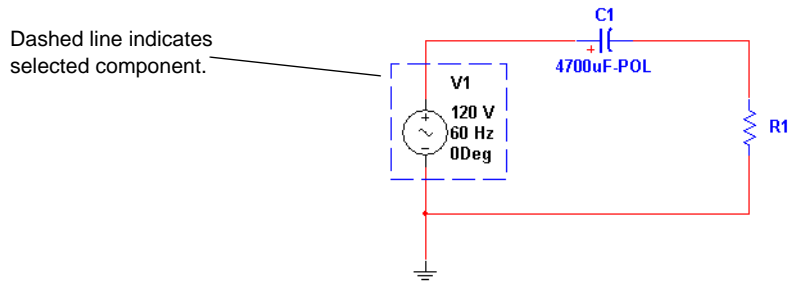

**Tip** You can select individual elements in a component like the RefDes, label and so on. To move the selection to another element of the component, use the TAB key.

## Setting Dragging Selection Options

You can use the **Selection Rectangle** box in the **General** tab of the **Preferences** dialog box to set how part selection by mouse dragging functions.

Selection Rectangle

Intersecting     Fully enclosed

Hint: Hold the Z key during selection to toggle modes

Part is selected when a portion of it is contained in the dragged rectangle.

The entire part, including all text, labels, etc. must be in the dragged rectangle for part to be selected.

**Tip** To toggle between the **Intersecting** and **Fully Enclosed** modes, press and hold the Z key before dragging the mouse.

## 4.4.5 Moving a Placed Component

You can move a placed component to another location by doing one of the following:

- dragging the component
- selecting the component and pressing the arrow keys on your keyboard to move it up, down, or to either side in increments of one grid space.

**Note** Moving automatically adjusts the wiring to an appropriate configuration, unless you have disabled the **Autowire on move** option described in “4.5.6 Setting Wiring Preferences” on page 4-26.

➤ To move a component by dragging:

1. Click and hold the left mouse button on the desired component. The component is selected with a dashed line.



**Note** A component's symbol and labels can be moved independently or together — if you plan to move the component, be sure the whole component is selected, not just its label. Refer to “4.4.4 Selecting Placed Components” on page 4-13 for details.

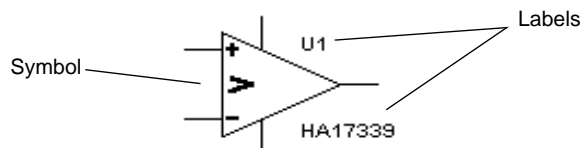

2. Drag the component to the desired location.

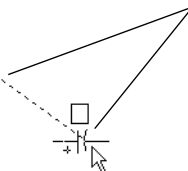

As you drag the mouse, a ghost image of the selected part appears attached to the cursor, along with a dashed line that connects the ghost image to the selected component's original location. To toggle this feature, see “Showing/Hiding ‘Move’ Lines” on page 4-16.

3. Release the mouse button when the ghost image is in the desired location.

➤ To move a component's label:

1. Click and hold the left mouse button on the desired label. The label is selected as illustrated below.



2. Drag the component to the desired location.

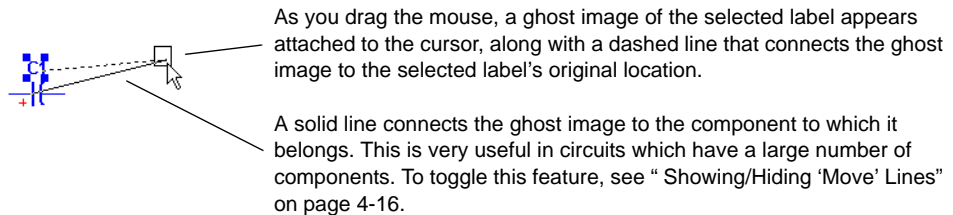

3. Release the mouse button when the ghost image is in the desired location.

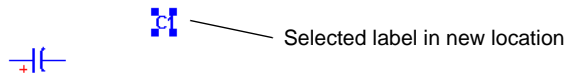

### Showing/Hiding 'Move' Lines

You can use these checkboxes in the **General** tab of the **Preferences** dialog box to show a line between text or parts that are being moved and their original location.

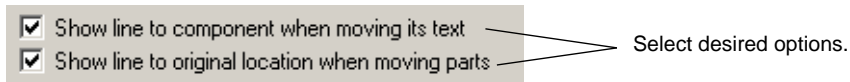

## 4.4.6 Copying a Placed Component

➤ To copy a placed component:

1. Select the desired component and choose **Edit/Copy**.

*Or*

Right-click on the desired component, and, from the pop-up menu that appears, choose **Copy**.

2. Select **Edit/Paste**.

*Or*

Right-click on the workspace select **Paste** from the pop-up menu that appears.

3. The cursor shows a “ghosted” version of the copied component. Click at the location where you want the copied component placed.

**Note** You can also copy a component using the Windows control keys for cut (CTRL-X), copy (CTRL-C) and paste (CTRL-V).

## 4.4.7 Replacing a Placed Component

You can easily replace a placed component by using the **Replace** button on the component’s properties dialog box. The most common use for this feature is when you wish to start a circuit with virtual components, and then replace them with the nearest real components.

➤ To replace a placed component:

1. Double-click on the component you want to replace. The component’s properties dialog box appears.

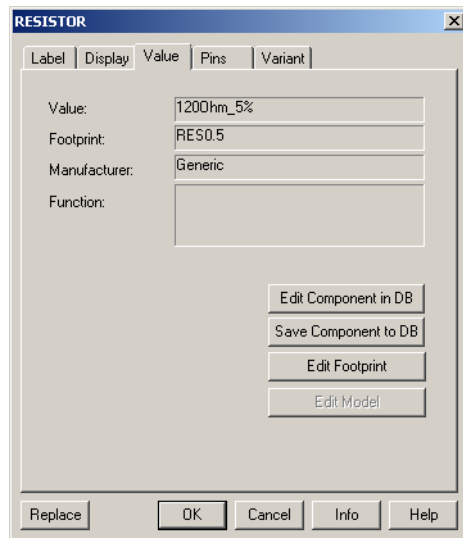

2. Click **Replace**. The **Select a Component** browser appears.
3. Select a new component and click **OK**. The new component appears on the circuit window in the place of the previous one. For more details about the component browser, see “4.4.1 Using the place component browser” on page 4-4.



**Note** If you wish to replace multiple selected parts with the same quantity of one specific part, select **Tools/Replace Component**. See also, “A.1.7.11 Tools/Replace Component” on page A-25.

## 4.4.8 Controlling Component Color

The default color used for a component and the background color of the circuit window are controlled in the **Sheet Properties** dialog box, as described in “3.4.2.1 Sheet Properties - Circuit Tab” on page 3-26.

- To change the color of a placed component, right-click on the component and choose **Color** from the pop-up menu that appears. You are presented with a color palette. Choose a color and click **OK** to apply it to the selected item.

## 4.5 Wiring Components

A basic wire can be created by clicking on any one of a part's symbol pins. This creates a wire that can then be routed to either another symbol pin, or to another wire. If routed to a wire, when placed a *junction* is automatically created to differentiate the case of two wires crossing and two wires connected.

Wires can also be started by double-clicking anywhere on the circuit. This creates a junction at that location and starts wiring from that point. If a symbol's pins are dropped onto either a wire or another pin, a connection is automatically made.

Each time a wire is placed it either creates a new *net*, or joins an existing one. A *net* is a collection of wires all of which define a common electrical potential. The term net is typically used to describe this concept when discussing PCB layout. This concept is equivalent to the concept of a *node* when discussing SPICE-based circuit simulation.

Nets are typically assigned the next available small integer value. If two nets are merged by wiring them together, there are rules used to decide which of the two names the new net will bear, however in general the smaller-numbered net wins. You may also manually assign a name to a net.

Within a single-page of a circuit, a net may be manually renamed to be the same name as another on the same page. In this case, the two nets are merged together. This is called *virtual wiring* and may be used to reduce the complexity of circuits. Except for special reserved nets, virtual wiring may not be used across pages or across levels in the hierarchy. For details, see “4.5.10 Virtual Wiring” on page 4-28.

Certain pre-defined named nets are considered global across an entire design. That is to say, anytime a net at any level in the hierarchy or on any page is re-named to one of these reserved

nets, it joins this net. These reserved nets are 0, GND, VCC, VDD, VEE, and VSS. Net 0 corresponds to analog ground, and is the reference for all voltages during simulation. GND is a digital ground (as it is common for the purposes of PCB layout to wish to isolate these two ground nets).

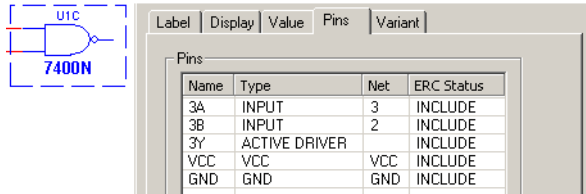

These reserved nets are most often used in conjunction with *hidden symbol pins*. These are pins that are not shown on a schematic, as they and their accompanying wires would clutter the schematic to too great an extent, but are nonetheless connected for the purposes of simulation and layout. For example, a TTL digital AND gate would implicitly be connected to GND and VCC via hidden pins.

## 4.5.1 Wiring Components Automatically

- To wire two components together automatically:
  1. Click on a pin from the first component to start the connection (your pointer turns into a crosshair  $\rightarrow$ ) and move the mouse. A wire appears, attached to your cursor.
  2. Click on a pin on the second component to finish the connection. Multisim automatically places the wire, which snaps to an appropriate configuration (unless you have disabled the “autowire on connection” option, as described in “4.5.6 Setting Wiring Preferences” on page 4-26). The wire is numbered as a net. After a wire is connected between two pins the cursor returns to its normal mode and is ready for your next command.

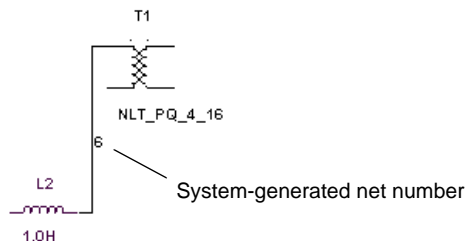

**Tip** If the connection was not successful, you may be trying to place the wire too close to other surrounding components. Try to make the connection at a slightly different location, or use manual wiring, as described in the following section.

**Note** When wiring a component with multiple sections, an “X” indicates that a common pin has been connected in another section of the component. In the example below, U5A and U5B are sections of a Dual, Current Controlled Operational Transconductance Amplifier. These two sections share a common pin on the IC (pin 11, VB+).

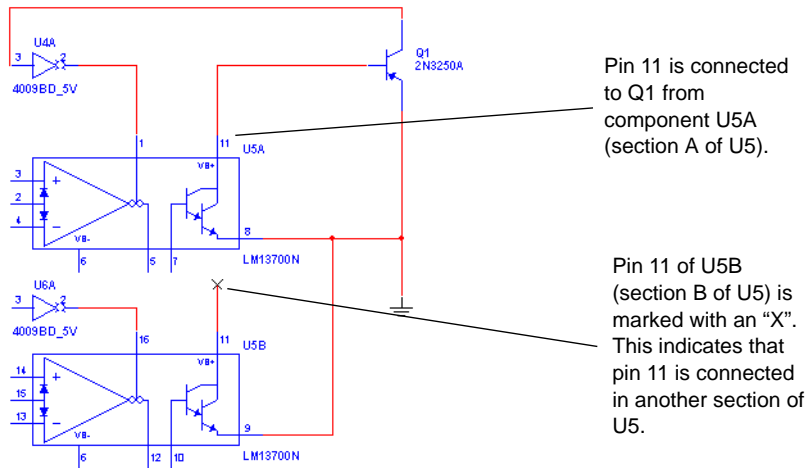

- To delete a wire, click on it and press **DELETE** on your keyboard or right-click on it and choose **Delete** from the pop-up menu that appears.

#### 4.5.1.1 Autowire of Touching Pins

You have the option to make an automatic connection if a component pin is touching a wire, another pin or a junction.

- To enable/disable this option, select or deselect the **Autowire when pins are touching** checkbox in the **General** tab of the **Preferences** dialog box.

- Refer to the steps in the following example to automatically connect a component to a wire:

**Step 1**

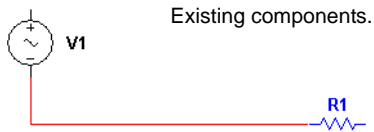

**Step 2**

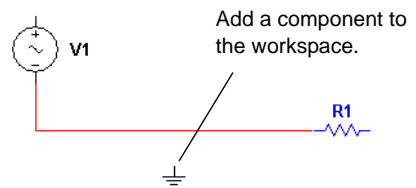

**Step 3**

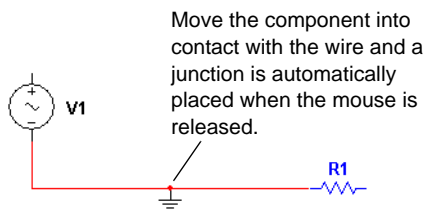

**Step 4**

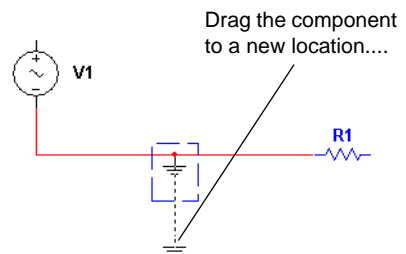

**Step 5**

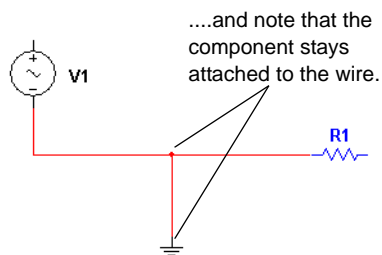

- Similarly, follow the steps in the example below to connect two components:

**Step 1**

Existing components.



**Step 2**

Move one component into contact with the other and a junction is automatically placed when the mouse is released.

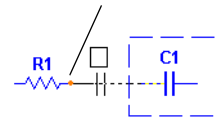

**Step 3**

Drag the component to a new location....

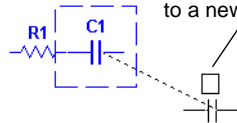

**Step 4**

....and note that the two components stay wired.

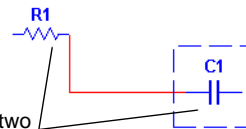

**Tip** Use the technique illustrated in the example above to automatically connect a component to a junction.

## 4.5.2 Wiring Components Manually

- To wire two components together, manually:
  1. Click on a pin from the first component to start the connection (your pointer turns into a crosshair  $\rightarrow$ ) and move the mouse. A wire appears, attached to your cursor.
  2. Control the flow of the wire by clicking on points as you move the mouse. Each click “fixes” the wire to that point. For example:

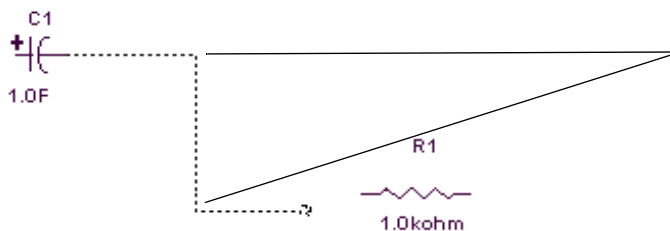

The mouse button was clicked at these locations.

By default, Multisim “skips over” (avoids) components to which it is not connected. For example:

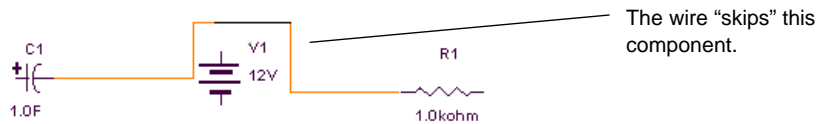

To pass through intermediary components instead, position the wire at the desired location beside the intermediary component and press SHIFT on your keyboard while dragging the wire. For example:

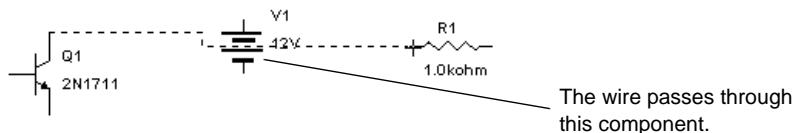

3. Click on the desired pin of the second component to finish the connection. The wire snaps to an appropriate configuration and the connection is numbered.
- Note** To stop the wiring process at any time, press ESC on your keyboard.
- To delete a wire, click on it and press DELETE on your keyboard or right-click on it and choose **Delete** from the pop-up menu that appears.

### 4.5.3 Combining Automatic and Manual Wiring

You can combine the two methods of wiring when placing a single wire. When in autowiring mode, Multisim assumes you always want to perform automatic wiring until you click somewhere, which “locks” the wire to that point (this is manual wiring). Multisim then continues with automatic wiring, until you click once more—either at a destination pin or wire to complete the connection, or at another interim point on the wire you are placing. This method allows you to use automatic wiring for most connections, and use manual wiring only for difficult, critical or sensitive paths.

### 4.5.4 Marking Pins for No Connection



You can place NC (no connection) markers on selected component pins to prevent inadvertently wiring to these pins.

If you attempt to connect a wire to a pin with an NC marker, the connection is prevented and a message appears advising that you cannot connect to a pin marked as “no connection”.

➤ To place an NC marker on a component's pin:

1. Select **Tools/Toggle NC Marker**. The cursor changes to a crosshair as shown below.

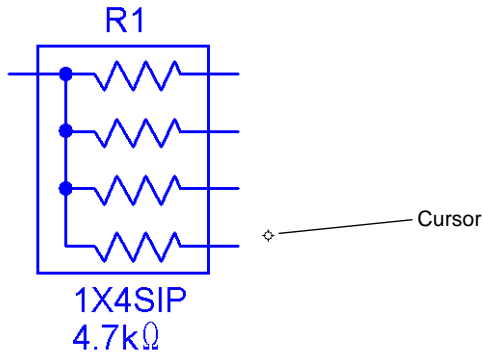

2. Click the crosshair on the desired pin to place the NC marker.

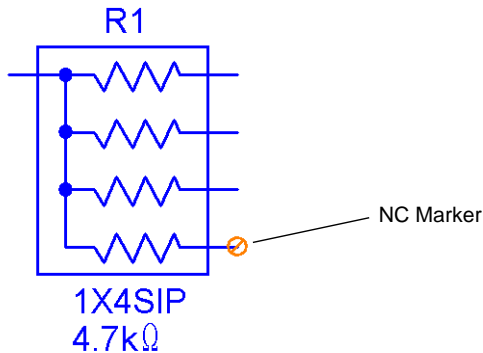

➤ To exit the place NC marker mode:

1. Select **Tools/Toggle NC Marker**.

*Or*

Press ESC on your keyboard.

The crosshair on the cursor is replaced with a pointer.

➤ To place an NC marker on a component's pin via the component's properties dialog:

1. Double-click on the component and click on the **Pins** tab.

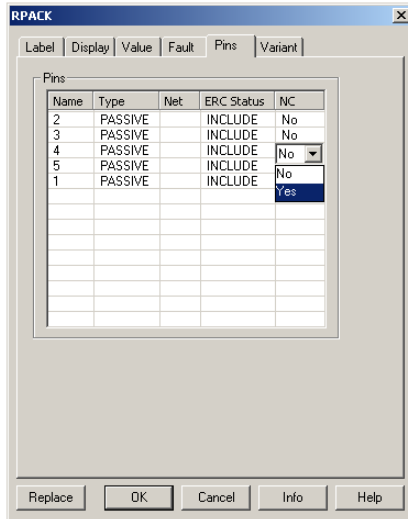

2. Click in the field in the **NC** column for the desired pin, select Yes from the drop-down list that appears and click **OK** to close the dialog box.

An NC marker is added to the selected pin on the schematic.

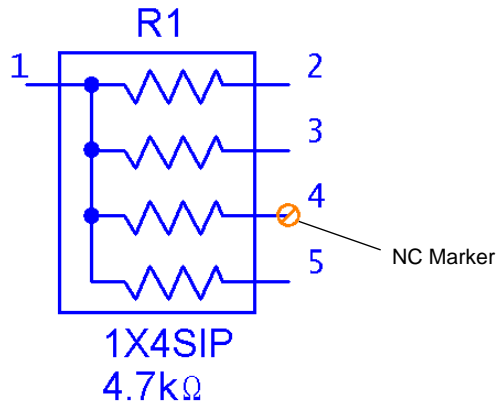



## 4.5.5 Placing Wires Directly Onto Workspace

For more flexibility during wiring, you can also start and end a wire in “mid-air”, that is, without attaching it to a component or starting from a previously placed junction.

➤ To place a wire using the menu:

1. Select **Place/Wire**.

*Or*

Right-click on the workspace and select **Place Schematic/Wire** from the pop-up menu that appears.

2. Click to place a junction on the workspace and then move the mouse to route the wire as desired.
3. Click as desired to lock the wire to a specific point on the workspace.
4. Double-click to place a junction in “mid-air” and end the wire placement.

*Or*

Click to attach the wire to an existing wire or component pin.

**Note** You can also double-click to auto-insert a junction on the workspace and start wiring as described above.

## 4.5.6 Setting Wiring Preferences

You can set your preferences for how Multisim controls the automatic wiring.

➤ To set your wiring preferences:

1. Choose **Options/Global Preferences** and select the **General** tab.
2. In the **Autowire** box, enable any or all of the following options:
  - **Autowire when pins are touching** — makes an automatic connection if a component pin is touching a wire, another pin or a junction.
  - **Autowire on connection** — chooses the most efficient path to wire the selected components together. Disabling this option gives you more control over the wire path, as Multisim follows the exact path of your cursor.
  - **Autowire on move** — when you move a wired component, Multisim reshapes the wire to the most efficient path. Disabling this option means that the wires will move exactly in the shape and direction that you move a wired component.
  - **Delete associated wires when deleting** — wires attached to a component will be deleted when that component is deleted.
3. Click **OK**.

## 4.5.7 Modifying the Wire Path

- To alter the shape of the wire once it is placed:
  1. Click on the wire. A number of drag points appear on the wire:

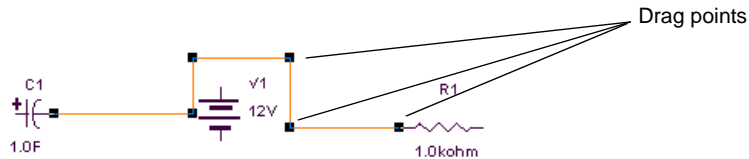

2. Click any of these and drag to modify the shape.

*Or*, more commonly,

Move your cursor anywhere on the wire. When your cursor changes to a double arrow, click and drag, in the direction of the arrows, to modify the shape.

You can add or remove drag points to give you even more control over the wire shape.

- To add or remove drag points, press CTRL on your keyboard and click on the wire at the location where you want the drag point added or removed.

## 4.5.8 Controlling Wire Color

The default color used for wires is controlled by the **Preferences** dialog box, as described in “3.4.2.1 Sheet Properties - Circuit Tab” on page 3-26.

- To change the color of a placed wire, or a wire segment, from its default values, right-click on the wire and choose **Wire Color** or **Segment Color** from the pop-up menu that appears. You are presented with a color palette. Choose a color and click **OK** to apply it to the selected item.

**Note** For more on color schemes, see “3.4.2.1 Sheet Properties - Circuit Tab” on page 3-26.

## 4.5.9 Moving a Wire

- To disconnect a wire and move it to another location in your schematic:
  1. Place your cursor at the point where you wish to disconnect the wire. The cursor changes to an “x” with two parallel lines, as shown below.

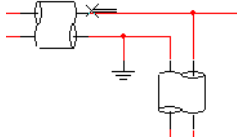

2. Click *once*. The cursor changes to a crosshair.
3. Move the cursor to where you wish to reconnect the wire and click *once*. The wire is now connected to the new location.

## 4.5.10 Virtual Wiring



- To make a virtual connection between components, modify the components' net names to be the same as described below:

1. Double-click on the wire. The **Net** dialog box appears:

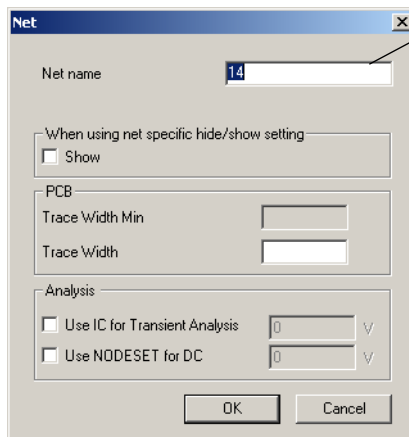

Net name that appears on the schematic.

For more information on the **Net** dialog box, see “4.9.2 Modifying Net Names” on page 4-35.

2. Change the **Net Name** to match that of the net to which you wish to make the virtual connection. For instance, if you want to connect the selected net to net 21, enter 21 in the **Net Name** field.
3. To confirm your settings, click **OK**. To cancel them, click **Cancel**.

**Note** You should exercise caution when changing net names, as they are critical to your circuit's connectivity as understood by simulation or PCB layout.

4. Multisim prompts you to confirm that you want this duplication. Click **Yes**. Multisim creates a virtual connection between the pins with the same net number.

## 4.6 Manually Adding a Junction (Connector)

Multisim automatically inserts junctions when you connect one wire to another wire to differentiate them from wires that are crossing but not connected. You can also manually place junctions on the workspace as desired.

➤ To manually add a junction:

1. Choose **Place/Junction**, or right-click on the workspace and select **Place Schematic/Junction** from the pop-up. Your cursor changes to indicate that a junction is ready to be placed.
2. Click on the location where you want the junction placed. A junction appears at the selected location.

**Note** You can place junctions on wires, on the workspace without them being attached to any other circuit element, and directly on the end of component pins. If you place a junction over two intersecting wires, they will be electrically connected.

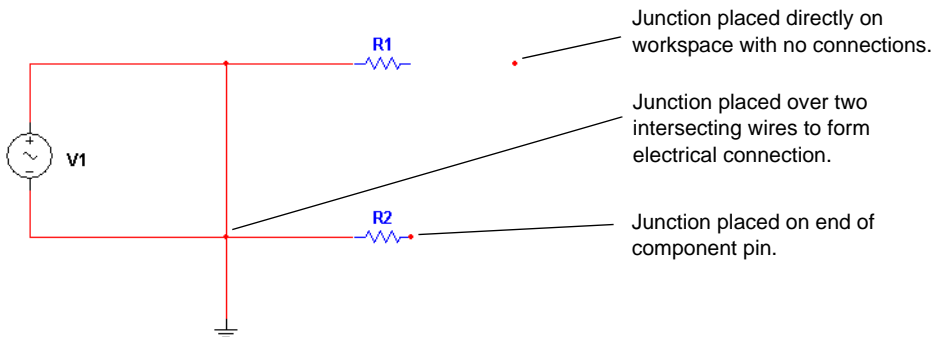
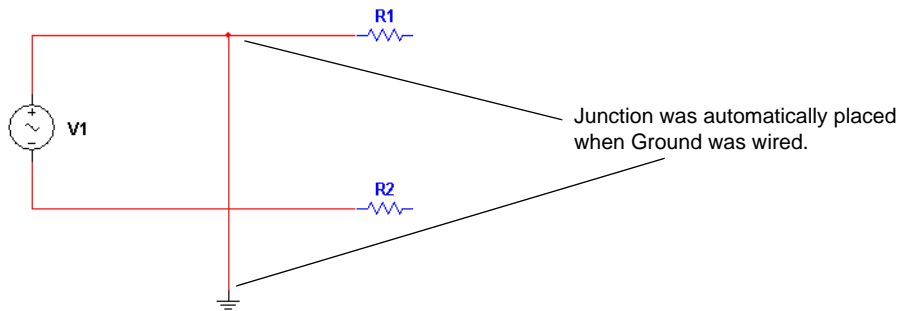

- To make a connection from a placed junction:
  1. Move your cursor close to the junction, until the cursor changes to a crosshair (✚) symbol.
  2. Click and drag a wire from the junction to the desired location and click to place.

## 4.7 Rotating/Flipping Placed Components

You can rotate or flip a placed component by either using the pop-up menu or selecting the component and using commands from the **Edit** menu. The instructions below describe the pop-up menu method only, but the commands for rotating/flipping placed components that are found in the **Edit** menu are the same. See “A.1.2 Edit Menu” on page A-4 for details.

- To rotate a component:
  1. Right-click on the component.

- From the pop-up menu that appears, choose **90 Clockwise** to rotate the component 90 degrees clockwise.

or

Choose **90 CounterCW** to rotate the component 90 degrees counter clockwise.

For example:

Unrotated:

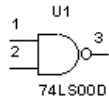

Rotated 90 degrees clockwise:

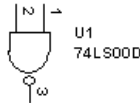

Rotated 90 degrees counter-clockwise:

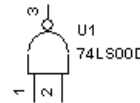

**Note** Text associated with the component, such as labels, values and model information, will be repositioned and rotated as a result of your action. Pin numbers will rotate along with the associated pin. Any wires attached to the component are rerouted automatically to maintain their connections using rubberbanding. If you do not want this to happen, it can be controlled in the **Wiring** tab of the **Preferences** dialog box.

➤ To flip a component:

- Right-click on the component.
- From the pop-up menu that appears, choose **Flip Horizontal** to flip the component horizontally.

Or

Choose **Flip Vertical** to flip the component vertically.

**Note** Text associated with the component, such as labels, model information and values, may be repositioned, but is not flipped. Any wires attached to the component are rerouted automatically.

For example:

Unflipped:

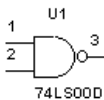

Flipped horizontally

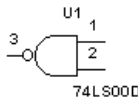

Flipped vertically

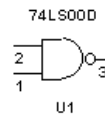

## 4.8 Finding Components in Your Circuit

- To quickly find a component in the workspace:
  1. Choose **Edit/Find**. The **Find Component** dialog box appears.

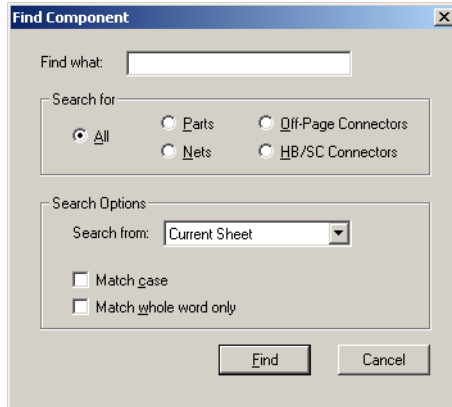

2. Enter a string in the **Find What** field.  
Wildcards are allowed, for example:
  - “V1” finds only the exact string “V1”
  - “\*1” finds any string ending with “1”
  - “V\*” finds any string starting with “V”
  - “\*V\*” finds any string containing “V”
  - a “?” anywhere in the string will match exactly one character. For example, “R?” will match “R1”, but not “R12”.
3. In the **Search for** box, select one of the following buttons:
  - All** — searches all elements for entered string
  - Parts** — searches all parts for entered string
  - Nets** — searches all nets for entered string
  - Off-Page Connectors** — searches all off-page connectors for entered string
  - HB/SC Connectors** — searches all HB/SC connectors for entered string.
4. In the **Search Options** box, select one of the following from the **Search From** drop-down:
  - Current Sheet** — search will be conducted on the contents of the current sheet only
  - Current Design** — search will be conducted on the contents of the current design only
  - All Open Sheets** — search will be conducted on the contents of all open sheets
  - All Open Designs** — search will be conducted on the contents of all open designs.

- Optionally, select one or both of the following checkboxes in the **Search Options** box:
  - Match Case** — select if you wish to make the search case sensitive
  - Match Whole Word Only** — click if you wish to find only whole words that match the entered string. If *not* selected, search will be for entered string *anywhere*. For example, if “1” is entered, search will yield “V1”, “R1”, “C1”, etc.
- Click the **Find** button. The results of your search are displayed in the **Results** tab of the **Spreadsheet View**.

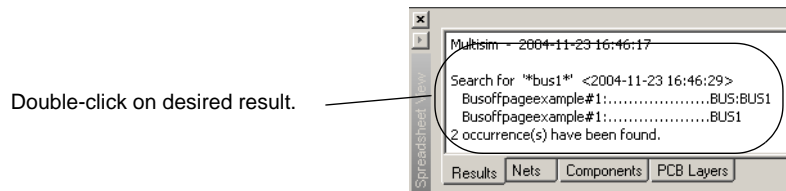

- Double-click on the desired item in the **Results** tab. The element is selected on the workspace, as in the example below.

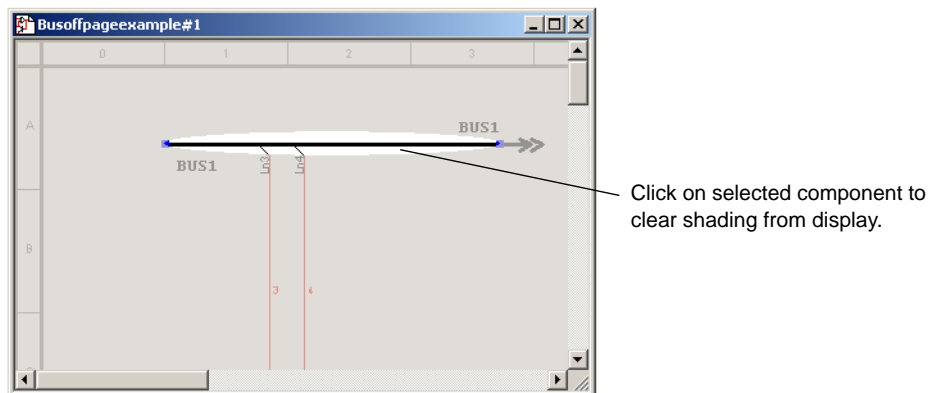

**Note** You can also right-click on the desired result and select **Go to** from the pop-up that appears.

## 4.9 Labeling

This section contains the following subjects:

- Modifying Component Labels and Attributes on page 4-34
- Modifying Net Names on page 4-35
- Adding a Title Block on page 4-36
- Adding Miscellaneous Text on page 4-39



- Circuit Description Box on page 4-47
- Graphic Annotation on page 4-43
- Capturing Screen Area on page 4-45

## 4.9.1 Modifying Component Labels and Attributes

To assign a label and/or Reference Designator to a placed component:

1. Double-click on the component. The component's properties dialog box appears.
2. Click the **Label** tab:

Enter or modify the RefDes and/or label here.

Enter any name or value you wish and have it displayed with the component.

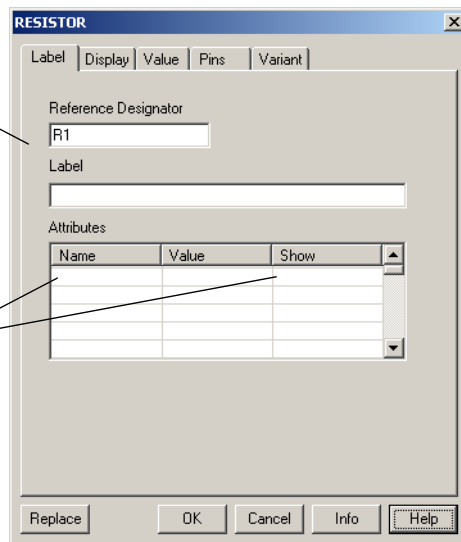

3. Enter or modify the label and/or RefDes text (which must be composed of letters or numbers only — no special characters or spaces).
4. Enter or modify the component attributes (which can be any name or value you choose to give them). For example, you could give the component the manufacturer name or a name that is meaningful to you such as “new resistor” or “revised May 15”.
5. Select the component attributes to display by clicking in the **Show** column. Attributes will be displayed with the component.

**Note** If you assign the same RefDes to more than one component, Multisim warns you that this is not possible. Because all RefDes's must be unique, you must change the RefDes or Cancel before you can proceed.

6. To cancel your changes, click **Cancel**. To save your changes, click **OK**.

## 4.9.2 Modifying Net Names

Multisim automatically assigns a net name to each node in the circuit. You can modify and move these net names.

- To modify a net name:

1. Double-click on the wire. The **Net** dialog box appears:

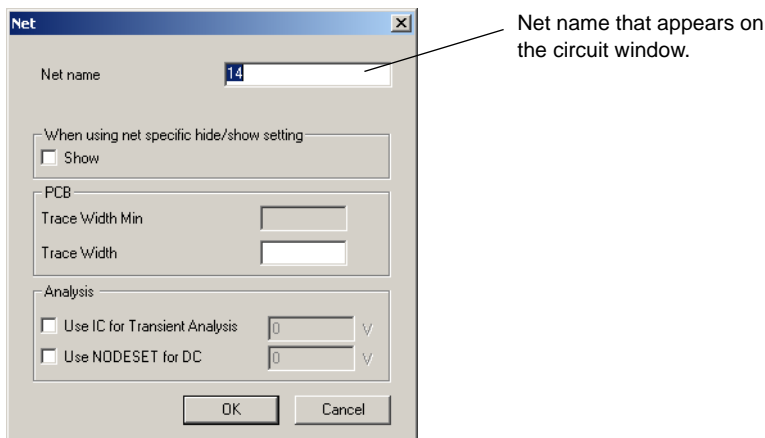

2. Enter the desired settings.
3. To confirm your settings, click **OK**. To cancel them, click **Cancel**.

**Note** You should exercise caution when changing net names, as they are critical to your circuit's connectivity as understood by simulation or PCB layout.

- To lock a net name in position so that it will not move when the wire is moved:

1. Double-click on the net name. A dialog similar to the following appears.

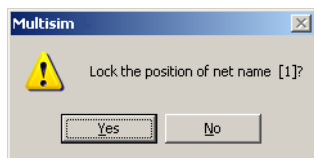

2. Click **OK**.

- To unlock a net name that has been locked in position, double-click on the net name and click **OK** when prompted.

**Note** You can also right-click on the net name and select lock/unlock.

## 4.9.3 Adding a Title Block

A powerful title block editor allows you to create customized title blocks. If desired, a title block can be included on every page of your design.

Various fields in the title block are automatically filled in depending upon the context and various document properties. When designing the title block, you choose one of the pre-defined fields or create your own. You choose appropriate fonts depending upon your language of preference.

Title blocks can include elements such as text, lines, arcs, bezier curves, rectangles, ovals, arcs, bitmaps, and so on.

- To add a title block to your circuit:

1. Select the title block template and place the title block in the desired location.
2. Enter the information about your circuit that is to be displayed.
3. Optionally, use the title block editor to change the appearance of the selected title block or create a new title block template.

Details follow.

- To add a title block of an existing format to your circuit:

1. Choose **Place/Title Block**. A standard “Open” dialog box appears. If necessary, navigate to the **Titleblocks** folder.
2. Select the desired title block template and click **Open**. The selected title block appears attached to your cursor. Drag and drop it in the desired location, typically the lower-right corner of the page.

Electronics Workbench 801-111 Peter Street Toronto, ON M5V 2H1 (416) 977-5550		 design solutions for every desktop	
Title: Tut2	Desc.: Project 1		
Designed by:	Document No: 0001	Revision: 1.0	
Checked by:	Date: Sep 20, 2004	Size: A	
Approved by:	Sheet 1 of 1		

Sample title block

3. You can also move the placed title block by right-clicking on it and selecting one of:
    - **Move to/Bottom Left** — places the title block in the bottom-left corner of the workspace
    - **Move to/Bottom Right** — place the title block in the bottom-right corner of the workspace
    - **Move to/Top Left** — places the title block in the top-left corner of the workspace
    - **Move to/Top Right** — places the title block in the top-right corner of the workspace.
- To add a title block with a new format, refer to “5.3 Title Block Editor” on page 5-15 and then place the new title block on the circuit following the procedure above.

### 4.9.3.1 Entering the Title Block Contents

- To edit the contents of the title block:
1. Right-click on the title block and select **Properties** from the pop-up that appears.
- Or*
- Double-click on the title block.
- The **Title Block** dialog box appears.

Title	Circuit1		
Description	&l		
Designed by	Document No	0001	Revision
			1.0
Checked by	Date	&d	Size
			Custom
Approved by	Sheet	&p	of &P
Custom Field 1			
Custom Field 2			
Custom Field 3			
Custom Field 4			
Custom Field 5			

OK Cancel Help

2. The information that displays is in the following table. Make edits as desired and click **OK**.

**Note** If a field in the **Title Block** dialog box contains information, and that information does not appear in your title block, it is because the field that contains that information was not placed in the title block. If this occurs, right-click on the title block, select **Title Block Editor**, and place the required field in the title block. For details, see “5.3.2 Placing Fields” on page 5-18.

<b>Field</b>	<b>Description</b>
Title	Title of the circuit. Defaults to the circuit's filename. Corresponds to the #TITLE field that is placed using the Title Block Editor.
Description	A description for your project. Defaults to Project 1. Corresponds to the #DSCRPT field that is placed using the Title Block Editor.
Designed by	Designer's name. Corresponds to the #DESIGNED field that is placed using the Title Block Editor.
Document No.	Document number. Defaults to 0001. Corresponds to the #DOC_N field that is placed using the Title Block Editor.
Revision	Revision number of the circuit. Corresponds to the #REV field that is placed using the Title Block Editor.
Checked by	Name of person checking the circuit. Corresponds to the #CHECKED field that is placed using the Title Block Editor.
Date	Defaults to the date that the circuit was created. Corresponds to the #DATE field that is placed using the Title Block Editor.
Size	Size of the sheet, for example, "A". Corresponds to the #FMT field that is placed using the Title Block Editor.
Approved by	Name of person approving the circuit. Corresponds to the #APPROVED field that is placed using the Title Block Editor.
Sheet	The number of the current sheet and the total number of sheets. For example, Sheet 2 of 3. Corresponds to the #SN and #TSN fields that are placed using the Title Block Editor.
Custom Field 1	Information entered here will be placed in Custom Field 1. Corresponds to the #CUSTOM_1 field that is placed using the Title Block Editor.
Custom Field 2	Information entered here will be placed in Custom Field 2. Corresponds to the #CUSTOM_2 field that is placed using the Title Block Editor.
Custom Field 3	Information entered here will be placed in Custom Field 3. Corresponds to the #CUSTOM_3 field that is placed using the Title Block Editor.
Custom Field 4	Information entered here will be placed in Custom Field 4. Corresponds to the #CUSTOM_4 field that is placed using the Title Block Editor.
Custom Field 5	Information entered here will be placed in Custom Field 5. Corresponds to the #CUSTOM_5 field that is placed using the Title Block Editor.

---

**Caution** The width of a *field* as displayed in the **Title Block Editor** is not the same as the actual *text* that is placed in that field in the title block. The text in the title block will be as wide as the amount of text. It is also dependant on the font size. So if two fields are placed closed to each other they may overlap.

---

You can also place the following special symbols in the **Title Block** dialog box. When you return to the workspace, the symbol will be replaced by text as listed.

Symbol	Description
&p	page number
&P	total page number
&d	date
&t	time
&s	page name
&j	project name
&&	ampersand

## 4.9.4 Adding Miscellaneous Text

Multisim allows you to add text to a circuit, for example to label a particular part of a circuit.

- To add text:
  1. Choose **Place/Text** or right-click on the workspace and select **Place Graphic/Text** from the pop-up.
  2. Click on the location where you want the text placed. A text box with a blinking cursor appears.
  3. Type the text. The text box automatically grows to the correct size when you finish typing and click elsewhere in the workspace.

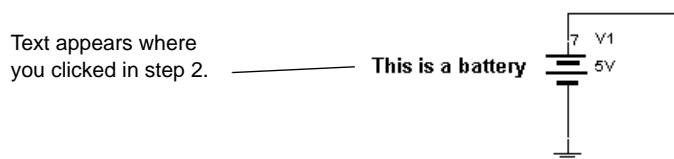

4. Click elsewhere on the circuit window to stop adding text.
- To delete text, right-click on the text box and choose **Delete** from the pop-up menu that appears, or select the text and press DELETE on your keyboard.
  - To change the color of text, right-click on the text box, choose **Pen Color** from the pop-up menu that appears, and choose the desired color. For details, see “3.3.4 Pop-up From a Selected Text Block or Graphic” on page 3-17.
  - To change the font options for the text, right-click on the text box, choose **Font** from the pop-up menu that appears, and choose the desired font options.

## 4.9.5 Adding a Comment

Adding a comment permits "redlining", which can be used to show engineering change orders, to facilitate collaborative work among team members, or to allow background information to be attached to a design.

You can “pin” a comment to the workspace, or directly to a component. When a component with an attached comment is moved, the comment also moves.

- To pin a comment to a component or the workspace:
  1. Select **Place/Comment**.
  2. Move the cursor to the desired location and click to place the comment.

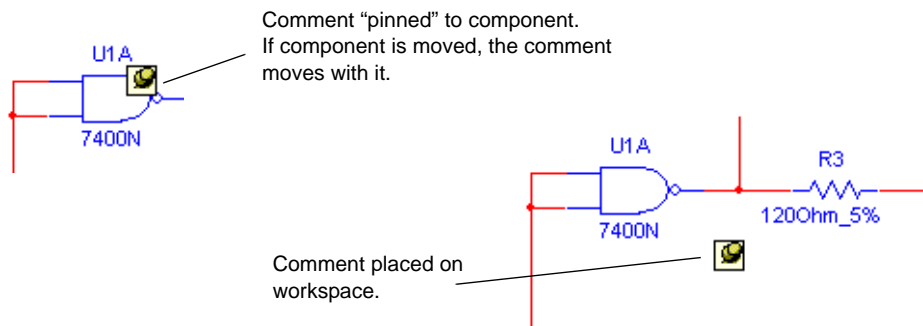

- To enter text in the placed comment:
1. Double-click on the placed comment. The **Comment Properties** dialog box appears.

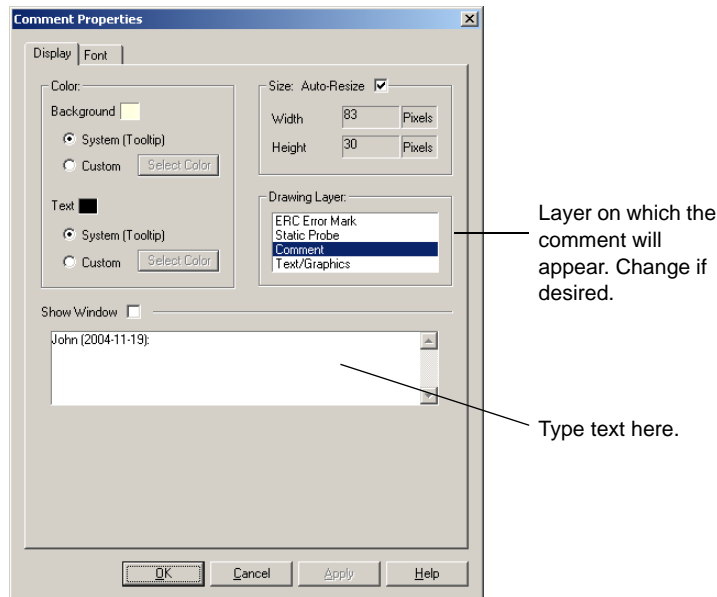

2. Type the desired text in the field at the bottom of the dialog. If you wish to show the note's contents, enable the **Show Window** checkbox.
3. Optionally, set the **Background** and **Text** colors in the **Color** box.
4. In the **Size** box, enter the **Width** and **Height**, or enable **Auto-Resize** to have the info box automatically resize to show all content.

**Note** “Tooltip” refers to the text that appears attached to the cursor if you hover it above a tool button.



- Optionally, click on the **Font** tab to change the comment's font.

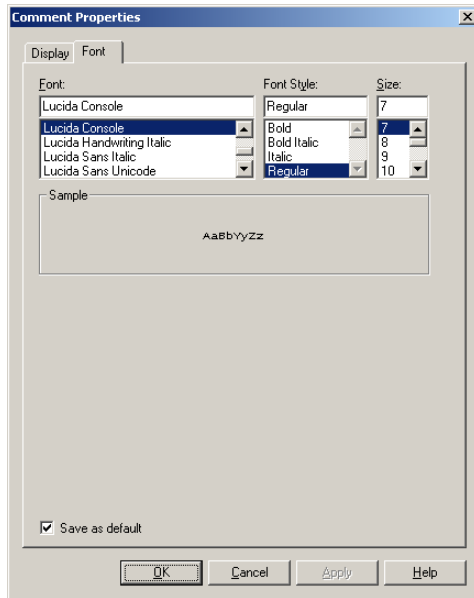

- Click **OK**. If you selected the **Show Window** checkbox in the **Display** tab, the comment displays. Otherwise, the **Comment** icon displays.

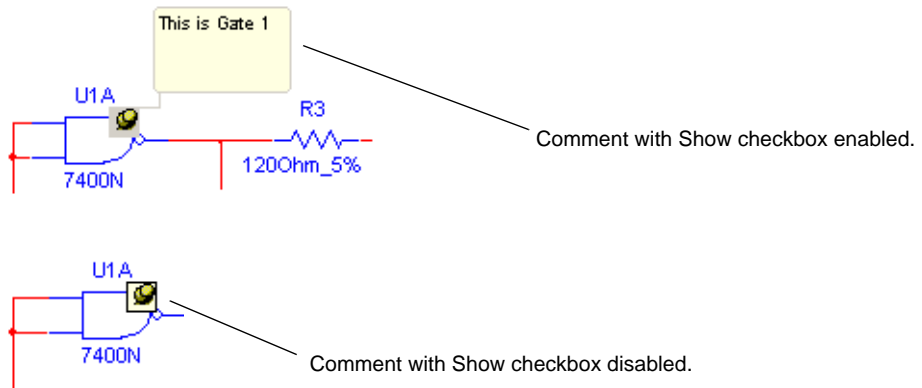

**Note** To enter text without using the **Comment Properties** dialog box, right-click on the placed comment, select **Edit Comment** from the pop-up that appears and type the desired text.

- To display a hidden comment, right-click on the desired **Comment** icon, and select **Show Comment/Probe** from the pop-up that appears.
- To see the contents of a hidden comment, hover the cursor over the comment. When you move the cursor, the comment disappears.
- To change the size of a displayed comment:
  1. Highlight its textbox.
  2. Drag the handles that appears.

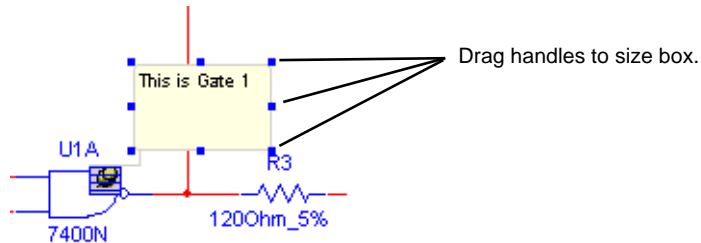

**Note** The size can also be changed from the **Display** tab of the **Comment Properties** dialog box.

## 4.9.6 Graphic Annotation

Use **Graphic Annotation** to add the following graphic elements to your workspace:

- Line
- Multiline
- Rectangle
- Ellipse
- Arc
- Polygon
- Picture
- Comment.







➤ To add a graphic element:



1. If the **Graphic Annotation** toolbar is not already showing, select **View/Toolbars/Graphic Annotation**.

*Or*

Right-click in the menu area and select **Graphic Annotation** from the pop-up that appears.

2. Click on the button in the **Graphic Annotation** toolbar for the desired graphic element and follow the directions for that element from the table below.

Button	Description
	Click on this button to place text on the workspace. Then click on the workspace in the location where you wish to place the text and type in the desired text. When finished, click anywhere on the workspace. The text box automatically sizes to display your text.
	Click on this button to draw a line. The cursor changes to a crosshair. Place the crosshair where you wish to start the line and click and hold the mouse button. Drag the crosshair to where you wish to end the line and release the mouse button. (To add an arrowhead, right-click on the placed line and select Arrow from the pop-up).
	Click on this button to draw a multiline, which consists of multiple connected line segments. The cursor changes to a crosshair. Place the crosshair where you wish to start the multiline and click the mouse button once. Move the crosshair to where you wish to end the current segment of the multiline and click the button once. Repeat until all segments of the multiline have been drawn. When you have drawn the last segment of the multiline, double-click the mouse button. (To add an arrowhead, right-click on the placed line and select Arrow from the pop-up).
	Click on this button to draw a rectangle. The cursor changes to a crosshair. Place the crosshair where you wish to start the rectangle and click and hold the mouse button. Drag the crosshair to where you wish to end the rectangle and release the mouse button.
	Click on this button to draw an ellipse. The cursor changes to a crosshair. Place the crosshair where you wish to place the center of the ellipse and click and hold the mouse button. Drag the crosshair to where you wish to end the ellipse and release the mouse button.
	Click on this button to draw an arc. The cursor changes to a crosshair. Place the crosshair where you wish to place the center of the arc and click and hold the mouse button. Drag the crosshair to where you wish to end the arc and release the mouse button. The arc will appear as an ellipse while it is being drawn, but when released, the right side only of the ellipse will be shown, thereby giving the arc.

Button	Description
	Click on this button to draw a polygon. The cursor changes to a crosshair. Place the crosshair where you wish to start the polygon and click the mouse button once. Move the crosshair to where you wish to end the the current segment of the polygon and click the button once. Repeat until all segments of the polygon have been drawn. When you have drawn the last segment of the polygon, double-click the mouse button.
	Click on this button to place a picture on the workspace. A dialog opens from where you can select the desired bitmap image. You can place either a .bmp or .dib file.
	Click on this button to place a comment on the workspace. For details, see “4.9.5 Adding a Comment” on page 4-40.

- To change the size of placed graphic components, select the component and click and drag the drag points that appear.



**Note** Placed graphics can also be manipulated using the pop-up menu. For details, see “3.3.4 Pop-up From a Selected Text Block or Graphic” on page 3-17.

## 4.9.7 Capturing Screen Area

You can capture an area of the screen and then manipulate the image as you would any other screen capture contained in the system clipboard. For example, you can paste it into the **Circuit Description Box**. (For details, see “4.10 Circuit Description Box” on page 4-47).

➤ To copy a section of your screen to the clipboard:

1. Select **Tools/Capture Screen Area**. A selection frame appears on your workspace.

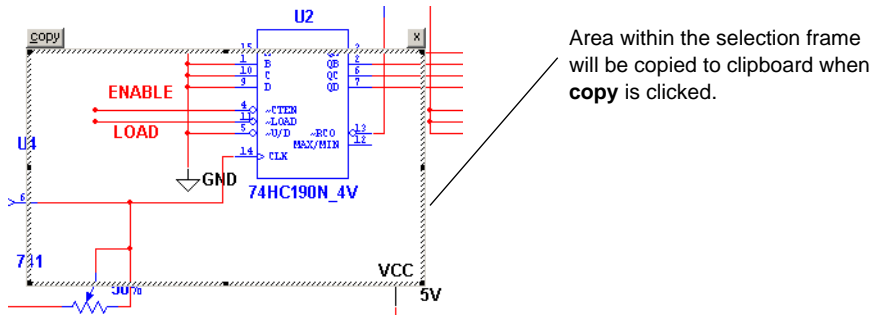

2. To move the frame to a different location:

- Move your cursor to the border of the frame. A crosshair is added to the cursor.

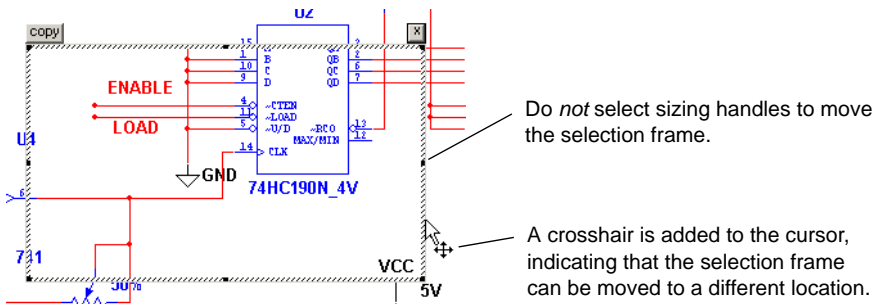

- Drag the selection frame to the desired location.

3. To re-size the selection frame:

- Move the cursor to one of the sizing handles.

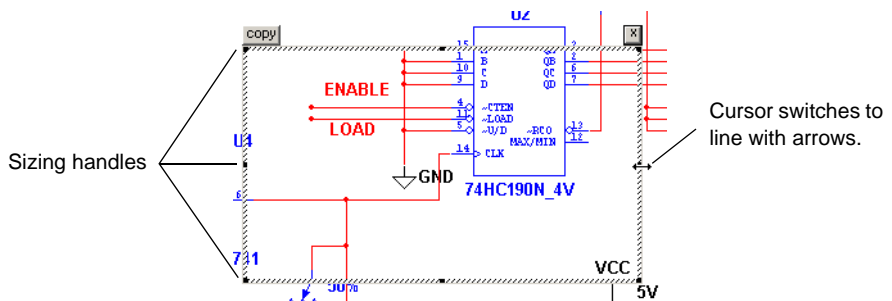

- Drag the cursor to re-size the selection frame.

4. Click on the **copy** button at the top left corner of the selection frame. The image inside the selection frame is copied to the system clipboard.
5. Click on the **x** at the top right corner of the selection frame to close it.

## 4.10 Circuit Description Box

In addition to adding text to a particular portion of a circuit, you can add general descriptions to your circuit using the **Circuit Description Box**. You can also place bitmaps, sound and video in the **Circuit Description Box**.

The contents of the **Circuit Description Box** are *viewed* in the top pane of the **Circuit Description Box** window (select **View/Circuit Description Box**). To *edit* the contents of the **Circuit Description Box**, select **Tools/Description Box Editor**.

**Note** The bottom pane of the **Circuit Description Box** contains any questions that you have entered using Multisim's **Forms** functionality. For details, see "4.11 Linking a Form to a Circuit" on page 4-59.

- To add or edit a description:



1. Choose **Tools/Description Box Editor**. The **Edit Description** window appears:
2. Enter text by typing directly into the window, or choose **Insert/Object** to place a bitmap, etc.

**Note** Changes made in the **Edit Description** window are not reflected in the **Circuit Description Box** (selected by **View/Circuit Description Box**) until you exit the **Edit Description** window.

3. Use the **Description Edit Bar** to edit the contents of the **Circuit Description Box** as needed. For details, see "4.10.3 Description Edit Bar" on page 4-57.
  4. When you are finished entering text, select **File/Close**. The **Edit Description** window closes and you are returned to the main Multisim workspace.
- To print your description, from the **Edit Description** window, click the **Print** button.

### 4.10.1 Formatting the Circuit Description Box

You can format the contents of the **Circuit Description Box** as listed below:

- **Paragraph Dialog Box** — use to enter paragraph formatting information. Refer to page 4-48 for details.
- **Tabs Dialog Box** — use to enter tab settings. Refer to page 4-49 for details.
- **Date and Time Dialog Box** — use to place a formatted date and/or time. Refer to page 4-49 for details.
- **Options Dialog Box** — use to set measurement units and text wrapping settings. Refer to

page 4-50 for details.

- **Insert Object Dialog Box** — use to select the type of object for insertion. Refer to page 4-50 for details.

### 4.10.1.1 Formatting Circuit Description Box Text

You can format currently-selected text in the **Circuit Description Box** by using the following commands from the **Description Edit Bar**:

- **Font** button — click to select the desired font name, size, etc.
- **Bold** button — click to make the selection bold.
- **Italic** button — click to italicize the selection.
- **Underline** button — click to underline the selection.

**Note** The above commands are also available by selecting **Format/Font**.

- **Color** button — click to display a palette where you pick a color for the text. This palette will also display if you select **Format/Font Color**.
- **Left Justification** button — click to align the selected paragraph(s) along the left margin. You can also select **Format/Align Left** to perform this command.
- **Center Justification** button — click to center-align the selected paragraph(s). You can also select **Format/Align Center** to perform this command.
- **Right Justification** button — click to align the selected paragraph(s) along the right margin. You can also select **Format/Align Right** to perform this command.
- **Insert Bullet** button — click to insert a bullet at the beginning of the selected paragraph(s). You can also select **Format/Insert a Bullet** to perform this command.

**Note** See also, “4.10.3 Description Edit Bar” on page 4-57.

### 4.10.1.2 Paragraph Dialog Box

Use the **Paragraph** dialog box to enter paragraph formatting information for the **Circuit Description Box**.

➤ To enter paragraph formatting information for the **Circuit Description Box**:

1. Open the **Edit Description** window as described in “4.10 Circuit Description Box” on page 4-47.

2. Select **Format/Paragraph** to display the **Paragraph** dialog box.

3. In the **Indentation** box, enter the measurements in the following fields as desired:

- **Left** — the distance the left side of the paragraph is indented from the left margin.
- **Right** — the distance the right side of the paragraph is indented from the right margin.
- **First Line** — the distance the first line of the paragraph is indented from the left



margin.

4. In the **Alignment** drop-down list, select whether the paragraph is left-, right-, or center-aligned.
5. Click **OK** to close the dialog box.

### 4.10.1.3 Tabs Dialog Box

Use the **Tabs** dialog box to enter tab settings for the **Circuit Description Box**.

- To enter tab settings for the **Circuit Description Box**:

1. Open the **Edit Description** window as described in “4.10 Circuit Description Box” on page 4-47.
2. Select **Format/Tab** to display the **Tabs** dialog box.
3. Enter the desired position for the tab (for example 1.25”) in the **Tab Stop Position** field and click **Set**.



**Note** You can also click in the top ruler bar to place a tab.

- To remove a tab setting:

1. Highlight the desired setting and click **Clear**.

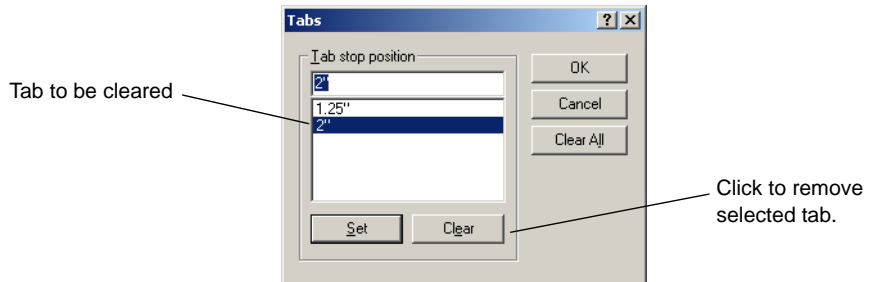

2. To clear all tabs, click **Clear All**.

### 4.10.1.4 Date and Time Dialog Box

Use the **Date and Time** dialog box to enter a formatted date and/or time in the **Circuit Description Box**.

- To place a date and/or time in the **Circuit Description Box**:

1. Open the **Edit Description** window as described in “4.10 Circuit Description Box” on page 4-47.
2. Click at the location where you wish to place the date and/or time.





3. Select **Insert/Date and Time** to display the **Date and Time** dialog box.

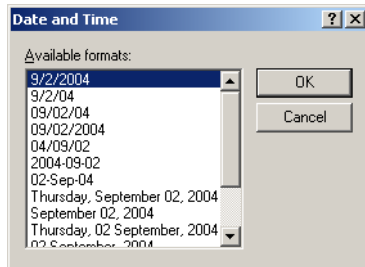

4. Select the desired date/time format from the **Available Formats** list and click **OK** to place the selection.

### 4.10.1.5 Options Dialog Box

Use the **Options** dialog box to select the measurement units and text wrapping settings used in the **Circuit Description Box**.

- To set the measurement units and text wrapping settings:
  1. Open the **Edit Description** window as described in “4.10 Circuit Description Box” on page 4-47.



2. Select **Options/Rich Edit Options** to display the **Options** dialog box and click the **Options** tab.
3. In the **Measurement Units** box, select one of **Inches; Centimeters; Points; Picas**.
4. Optionally, enable **Automatic Word Selection** to select one word at a time when you drag the cursor. If you wish to select one character at a time, clear this checkbox.
5. Click the **Rich Text** tab and select one of:
  - **No Wrap** — typed text will be on one line until you press the ENTER key.
  - **Wrap to Window** — typed text will go to the next line when it reaches the edge of the window.
  - **Wrap to Ruler** — typed text will go to the next line when it reaches the page margin.
6. Click **OK** to close the dialog box.

### 4.10.1.6 Insert Object Dialog Box

Use the **Insert Object** dialog box to select an object, such as a bitmap or chart, to insert in the **Circuit Description Box**.

- To insert an object:
  1. Open the **Edit Description** window as described in “4.10 Circuit Description Box” on page 4-47.
  -  2. Select **Insert/Object** to display the **Insert Object** dialog box.
  3. To create a new object, enable the **Create New** button (this is the default setting).
  4. Select the desired object from the **Object Type** list.
  5. Optionally, enable **Display As Icon** to view an icon representing the file.
  6. Click **OK**.
- To create an object from an existing file:
  1. Enable the **Create from File** button.
  2. Enter the desired filepath and name in the **File** field, or click **Browse** and navigate to the desired file from the **Browse** dialog box that appears.
  3. Optionally, enable **Link** to link the object to the original file. Any updates to the original file are reflected in the object.

## 4.10.2 Scrolling with Events During Simulation

Along with descriptive text and graphics, the **Circuit Description Box** lets you synchronize scrolling and display of text, graphics or video with events in the simulation. You do this by placing Measurement Probes in your design and setting the Probe Properties with the events that you would like to have synchronized with the scrolling or display of text, graphics or video.

### 4.10.2.1 Scrolling Text During Simulation

- To make text scroll automatically during a simulation:
  1. Enter text in the **Circuit Description Box** as desired.



2. Select **Simulate/Instruments/Measurement Probe** and click to place a probe at the desired point, as in the following example. The simulation must *not* be running at this point. This is the point where the desired event occurs. For example, when the voltage is equal to 5 V.

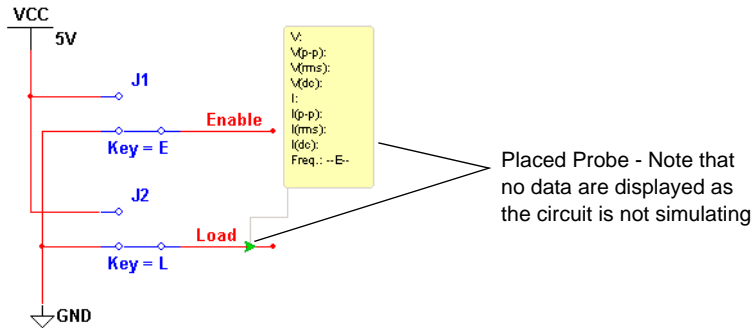

**Note** For more details on the probe, see “10.15 Measurement Probe” on page 10-40.

3. Double-click on the placed probe to display the **Probe Properties** dialog box, and click on the **Description Box** tab.
4. Click **New**. The blinking text cursor moves to the **Condition(s)** field.
5. Click on the button to the right of the **Condition(s)** field and build the equation from the pop-up that appears. In this case we are entering the condition “V=5”, meaning the condition required to scroll the text will be achieved when the voltage at the probe equals 5 volts.
6. From the **Action** drop-down list, select **Start Scrolling**.
7. In the **Parameter** field, type the scroll speed, for example, “100” (this equals a scroll rate of 100 pixels per 10 seconds).

8. Click **Apply**. You should end up with something similar to the following.

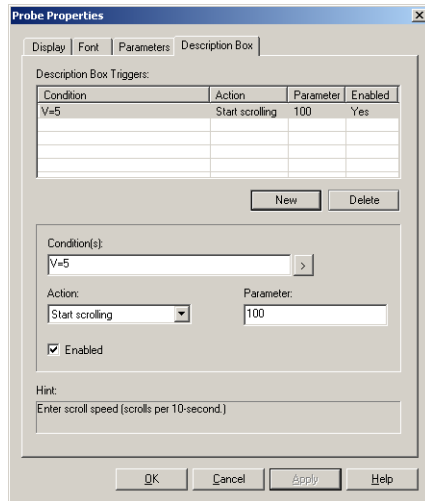

9. Click **OK** to close the dialog box.

When you run the simulation, the text will scroll when the voltage at the probe equals 5 V.

**Note** To disable a trigger, highlight it in the **Description Box Triggers** area and deselect the **Enabled** checkbox.



10. Click **Simulate** in the **Main** toolbar. The text in the **Circuit Description Box** will scroll when the conditions set in the **Description Box** tab of the **Probe Properties** dialog box are met.

**Note** Remember to leave the **Circuit Description Box** open when you click **Simulate**.

### 4.10.2.2 Playing a Video Clip

- To play a video clip during simulation:
  1. Open the **Edit Description** window by selecting **Tools/Description Box Editor**.
  2. Click at the point where you wish to place the video clip.
  3. Select **Insert/Object** and select **Create from File**.
  4. If you wish to have changes to the original file reflected in Multisim, enable **Link**.
  5. Click **Browse** and navigate to the desired video clip.
  6. Click **OK** to place the clip.

- Click once on the clip to select it and select **Insert/Label**. Enter the name of the label in the **Label Name** field of the **Description Label** dialog that appears and click **OK**. The clip's filename (in this case, "Filmclip.mpg") appears enclosed in rails as shown below.



- Select **Simulate/Instruments/Measurement Probe** and click to place a probe at the desired point, as in the following example. The simulation must *not* be running at this point

**Note** This point is where the desired condition will occur. For example, the voltage becomes equal to 5 V.

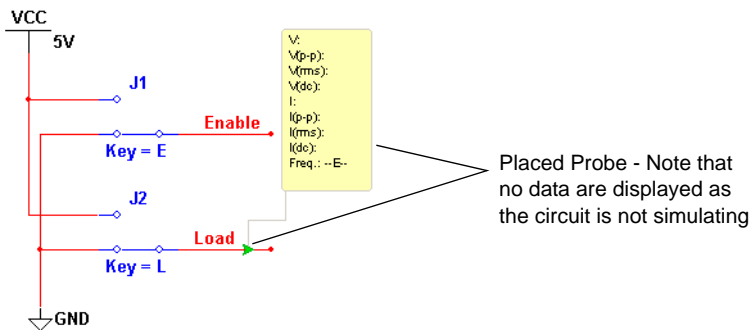

- Double-click on the placed probe to display the **Probe Properties** dialog box, and click on the **Description Box** tab.
- Click **New**. The blinking text cursor moves to the **Condition(s)** field.
- Click on the button to the right of the **Condition(s)** field and build the equation from the pop-up that appears. In this case we are entering the condition "V=5", meaning the condition required to run the clip will be achieved when the voltage at the probe is 5 volts.
- From the **Action** drop-down list, select **Play Media Clip**.
- In the **Parameter** field, type the name of the label that you placed around the video clip in the **Circuit Description Box**, (as described in "4.10.2 Scrolling with Events During Simulation" on page 4-51). In this case, we used Label 2.

14. Click **Accept**. You should end up with something similar to the following.

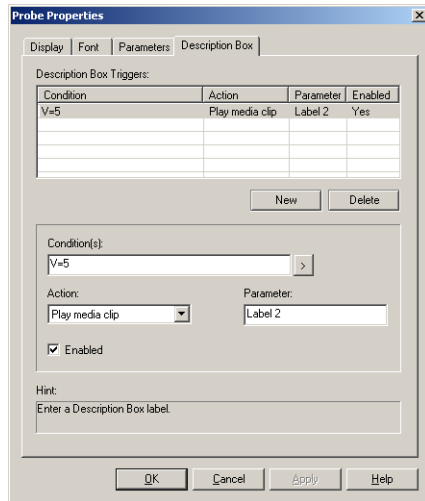

15. Click **OK** to close the dialog box.

When you run the simulation, the video clip will play when the voltage at the probe equals 5 V.



16. Click **Simulate** in the **Main** toolbar. The video clip will run when the parameters set in the **Description Box** tab of the **Probe Properties** dialog box are met.

**Note** Remember to leave the **Circuit Description Box** open when you click **Simulate**.

**Note** You can also run audio clips during simulation using the above procedure.

### 4.10.2.3 Description Label Dialog Box

You can insert labels in the **Circuit Description Box** that mark points where a certain action is to occur during simulation. For example, you might want to jump to a specific point in the text when the voltage at a specific node in the circuit drops below a pre-set value. Or, you may wish to run a film clip when another parameter has been met. The specific point in the text, and the film clip, are both marked with labels.

These actions are set up in the **Description Box** tab of the **Probe Properties** dialog box.

Use the **Description Label** dialog box to create a label to insert in the **Circuit Description Box**.

➤ To insert a label:

1. Open the **Edit Description** window as described in “4.10 Circuit Description Box” on page 4-47.

2. Select a block of text or an object that you wish to label. (This will be the *content* of the label).



3. Select **Format/Insert Label** to display the **Insert Label** dialog box.

4. Enter a *name* for the label in the **Label Name** field.

5. If you wish the content of the label to display in the **Circuit Description Box**, enable the **Show Content in Description Bar** checkbox.

**Note** The content of the label is the text or object that you selected in Step 2.

6. Click **OK** to accept your selections and close the dialog box. The label appears as shown below.

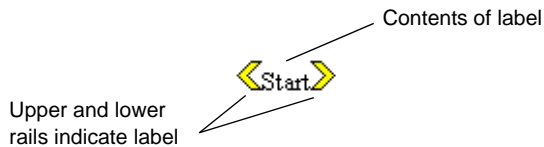

### 4.10.2.4 Edit Labels Dialog Box

➤ To edit existing labels in the **Circuit Description Box**:

1. Open the **Edit Description** window as described in “4.10 Circuit Description Box” on page 4-47.



2. Select **Edit/Labels** to display the **Edit Labels** dialog box.

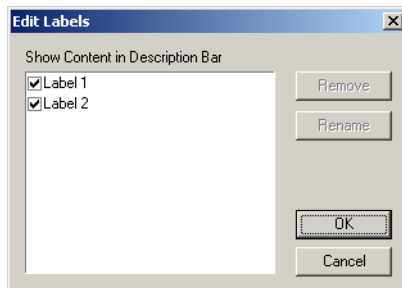

- To show/hide the contents of labels in the **Circuit Description Box**, enable/disable checkboxes as desired.
- To delete a label, highlight the desired label and click **Remove**.
- To rename a label, highlight the desired label and click **Rename**.



### 4.10.2.5 Other Actions

You can set up the following actions in the **Description Box** tab:













- **Jump to Label** — when the conditions entered in the **Condition(s)** field are met (for example,  $V=5$ ), the text in the **Circuit Description Box** will jump to the label that you enter in the **Parameter** field.
- **Pause Simulation** — when the conditions entered in the **Condition(s)** field are met (for example,  $V=5$ ), the simulation will pause for the amount of time (in seconds) that you enter in the **Parameter** field.
- **Stop Scrolling** — when the conditions entered in the **Condition(s)** field are met (for example,  $V=5$ ), scrolling of the text in the **Circuit Description Box** will stop.

## 4.10.3 Description Edit Bar



Button	Description
	<b>Insert Date and Time</b> button. Displays the <b>Date and Time</b> dialog box, where you select the format for the date and time. For details see “4.10.1.4 Date and Time Dialog Box” on page 4-49.
	<b>View and Select Options</b> button. Displays the <b>Options</b> dialog box, where you select measurement units and text wrapping settings. For details see “4.10.1.5 Options Dialog Box” on page 4-50.
	<b>Insert Embedded Object</b> button. Displays the <b>Insert Object</b> dialog box, where you select the type of object to insert. For details see “4.10.1.6 Insert Object Dialog Box” on page 4-50.



Button	Description
	<b>Create New Label</b> button. Displays the <b>Description Label</b> dialog box, where you enter the name of the new label to be inserted. For details see “4.10.2.3 Description Label Dialog Box” on page 4-55.
	<b>Edit Labels</b> button. Displays the <b>Edit Labels</b> dialog box. For details, see “4.10.2.4 Edit Labels Dialog Box” on page 4-56.
	<b>Bold</b> button. Makes the selection bold.
	<b>Italic</b> button. Makes the selection italic.
	<b>Underline</b> button. Underlines the selection.
	<b>Left Justification</b> button. Aligns the selected paragraph(s) along the left margin.
	<b>Center Justification</b> button. Center-aligns the selected paragraph(s).
	<b>Right Justification</b> button. Aligns the selected paragraph(s) along the right margin.
	<b>Font</b> button. Changes the font, size and color of the selected text.
	<b>Color</b> button. Displays a color palette where you pick a color for the currently-selected text.
	<b>Paragraph Format</b> button. Displays the <b>Paragraph</b> dialog box, where you enter paragraph formatting information. For details see “4.10.1.2 Paragraph Dialog Box” on page 4-48.
	<b>Insert Bullet</b> button. Inserts a bullet at the beginning of the selected paragraph(s).
	<b>Insert Tabs</b> button. Displays the <b>Tabs</b> dialog box, where you enter tab formatting information. For details see “4.10.1.3 Tabs Dialog Box” on page 4-49.

## 4.11 Linking a Form to a Circuit



You can use Multisim's form functionality to send circuits for approval, design reviews, or anywhere feedback on a design is needed. Once the form has been completed, the circuit file, including the completed form, can be returned to the originator via email.

Education edition users will find this particularly useful for assignments and tests that are given to students to be completed remotely. Once the questions have been answered, the circuit file, including the completed form, can be emailed to the instructor at the click of a button.

A form can include any of the following types of questions:

- **Multiple Choice** — the correct response is selected from two or more possible responses.
- **True/False** — a statement is made on the form and either **True** or **False** is selected as the response.
- **Data Entry** — a field for limited data entry is provided.
- **Free Form** — a field for more extensive data entry is provided.

The following sections discuss how to create a form, how to set form submission options and how the recipient should complete and submit the form.

### 4.11.1 Creating Forms

When reviewing these instructions, please note that the dialog box where you enter the questions is called **Edit Questions** in the Education Edition of Multisim. To access this dialog, select **Edit/Questions**.

➤ To create a form:



1. Select **Edit/Forms**. The **Edit Form** dialog box displays.

- **Title** — text entered here will appear as a title when the form is viewed.
- **Instruction** — enter instructions as desired in this field. Text entered here will appear above the first question when the form is viewed.
- **User Profile** — Each line entered here appears as a separate line with a user-editable field when the questions are viewed from the form. You can add, edit, or delete items in this area as desired.



2. Click on the **Add a Question** button and select the desired question type from the pop-up that appears. The **Edit Form** dialog box changes to reflect your selection.

3. Enter the question based on the following:

- **Multiple Choice** — enter a question in the **Question** field and enter possible responses in the **Candidate Answers** fields.
- **True/False** — enter a question requiring a true or false answer in the **Question** field.

- **Data Entry** — enter a question or instruction in the **Question** field.
  - **Free Form** — enter a question or instruction in the **Free Form** field.
4. As you proceed, the question types appear in the **Questions** tree of the **Edit Form** dialog box.

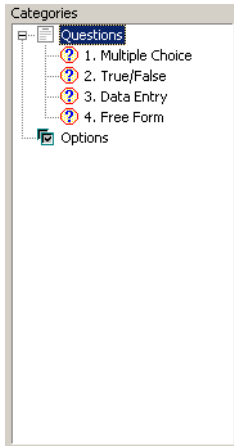

Click on a specific question in the tree to view its contents in the dialog box.



Click on the **Remove Selected Question** button to remove it completely.



Use the up and down arrows to change the position of the selected question in the tree. The sequence of the questions in the tree will be reflected when you view the completed form in lower pane of the **Circuit Description Box**.

5. Once you have entered the desired questions, click **OK** to close the **Edit Form** dialog box.
6. Select **View/Circuit Description Box**. The questions are displayed in the bottom pane of the **Circuit Description Box**.
7. Save the Multisim circuit file, which now includes the form. The completed circuit file can be electronically sent (for example, via email) to the desired recipients.

### 4.11.2 Setting Form Submission Options

Form submission options are usually set by the person that creates the form, before it is sent for completion.

When reviewing these instructions, please note that the dialog box where you enter the questions is called **Edit Questions** in the Education Edition of Multisim. To access this dialog, select **Edit/Questions**.

- To set options for submitting completed questions:



1. Select **Edit/Forms**. The **Edit Form** dialog box displays.
2. Click **Options** in the **Categories** area and complete the following:
  - **Email the circuit file to** — enable checkbox and enter the desired email address.
  - **Subject** — enter text to be placed in the email’s subject line.
  - **Body** — enter text to be placed in the body of the email message.
  - **Display the message** — enable checkbox and enter text that you wish to appear in the message that appears on the Multisim workspace when you click **Submit**.
3. Click **OK** to close the **Edit Form** dialog box.

**Note** See also “4.11.1 Creating Forms” on page 4-59 and “4.11.3 Completing Forms” on page 4-61.

### 4.11.3 Completing Forms



Complete and submit the form from a Multisim circuit that you received as explained below. Questions are answered directly from the **Circuit Description Box**.

- To answer questions:
1. Select **View/Circuit Description Box**.
  2. Enter the default information in the fields found at the top of the form in the lower pane of the **Circuit Description Box** (eg., Name, Date). These fields may vary from circuit to circuit.
  3. Complete the questions by selecting the desired response for multiple choice and true/false questions, or typing in answers to data entry and free form questions.
  4. Submit the completed questions:
    - To submit the completed questions on paper, click **Print**. A standard Print dialog appears. Enter the desired settings and click **Print**.
    - To submit the completed questions by email, click **Submit**. The circuit file, including the completed questions will be attached to an email that is addressed as set up in the **On Submit** options (see “4.11.2 Setting Form Submission Options” on page 4-60 for details). Send this email in the usual manner.

## 4.12 Printing the Circuit

Multisim allows you to control specific aspects of your printing, including:

- whether to output in color or black and white
- which pages of a design to print
- whether to include the background in the printed output
- page margins for printing
- scaling of the circuit's image to fit the printed output.

➤ To set the printing environment for circuits:

1. Select **File/Print Options/Print Circuit Setup**.

Set page margins for printed output.

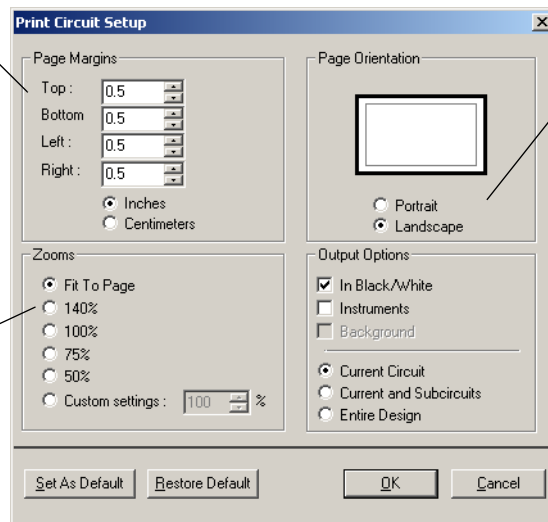

Select to print the circuit in the portrait (vertical) or landscape (horizontal) orientation.

Select an option to scale the circuit down or up in printed output.

2. Set the **Output Options** as desired:

Print Options	Description
In Black/White	Prints the circuit in black and white (for non-color printers). When disabled, colored components print in shades of grey.
Instruments	Prints the circuit and faces of the instruments used in the circuit on separate sheets.
Background	Includes the background in printed output. Use for color printers or white on black output. This option is disabled if <b>In Black/White</b> is selected.

Current Circuit	Prints the window that is currently active on the workspace.
Current and Subcircuits	Prints the currently active window and any subcircuits or hierarchical blocks that it contains.
Entire Design	Prints all circuits, subcircuits, hierarchical blocks and multi-pages from the design which includes the currently active window. For more information on hierarchical blocks and subcircuits, see "6.2 Hierarchical Design" on page 6-3.

3. Click **OK** to set the printing environment for the current circuit, or click **Set As Default** to set the the printing environment for all circuits.
- To preview your file before printing, choose **File/Print Preview**. The circuit appears in a preview window where you can zoom in, move from page to page, and send the circuit to the printer.

The **Print Preview** window offers the following toolbar:

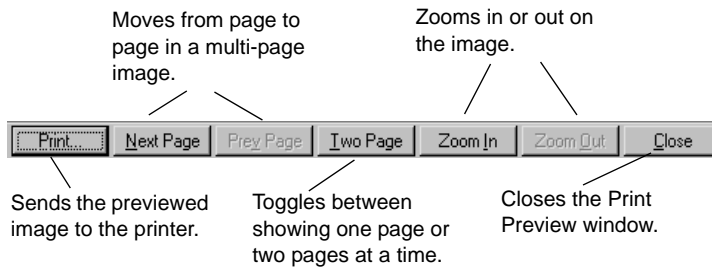

- To print the circuit file using the specified environment, choose **File/Print**. We recommend that you set your print options first.

# Chapter 5

## Schematic Capture - Advanced Functions



This chapter describes the advanced functions involved in creating a circuit in Multisim.

Some of the features described in this chapter may not be available in your edition of Multisim 9. Such features have an icon in the column next to their description. Refer to the release notes for a list of the features in your edition.

The following are described in this chapter.

<b>Subject</b>	<b>Page No.</b>
<b>Placed Component Properties</b>	5-2
Displaying Identifying Information about a Placed Component	5-2
Viewing a Placed Component's Value/Model	5-3
Controlling How a Placed Component is Used in Analyses	5-7
<b>The Spreadsheet View</b>	5-9
Spreadsheet View Results Tab	5-9
Spreadsheet View Nets Tab	5-10
Spreadsheet View Components Tab	5-11
Spreadsheet View PCB Layers Tab	5-14
Spreadsheet View Buttons	5-14
<b>Title Block Editor</b>	5-15
Enter Text Dialog Box	5-17
Placing Fields	5-18
Title Block Editor Spreadsheet View	5-21
Title Block Editor Menus	5-22
Toolbars	5-29
<b>Electrical Rules Checking</b>	5-34
ERC Options Tab	5-37
ERC Rules Tab	5-39
Component's Pins Tab	5-41

## 5.1 Placed Component Properties

Each component placed on the circuit window has a set of properties that control certain aspects of it beyond those stored in the Multisim database. These properties affect only the placed component, not other instances of that component in other circuits or other locations in this circuit. Depending on the type of component, these properties determine some or all of the following:

- the identifying information and labels about the placed component to be displayed on the circuit window (for details, see “4.9.1 Modifying Component Labels and Attributes” on page 4-34)
- the model of the placed component
- for some components, how the placed component will be used in analyses
- the component’s value or model and footprint.

### 5.1.1 Displaying Identifying Information about a Placed Component

As described in “3.4.2.1 Sheet Properties - Circuit Tab” on page 3-26, your settings in the **Circuit** tab of the **Sheet Properties** dialog box determine which identifying information is displayed on your circuit.

You can also override these settings for an individual placed component, as described here.

- To set the identifying information to be displayed for a placed component:
  1. Double-click on the component. A properties dialog box for the selected component appears.



2. Click the **Display** tab.

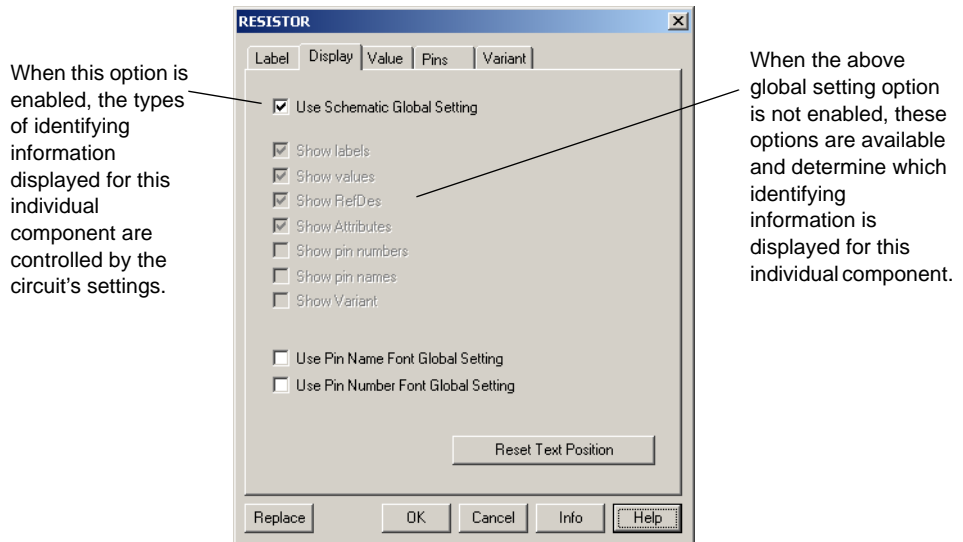

3. Disable **Use Schematic Global Setting**.
4. Enable the identifying information you want displayed for this component, and disable the identifying information you do not want displayed for this component.
5. To cancel your settings, click **Cancel**. To save your settings, click **OK**.

## 5.1.2 Viewing a Placed Component's Value/Model

The **Value** tab of the “properties” dialog box for a component shows the value/model being used for the placed component. Depending on whether the component is a “real” component or a virtual component, you see one of two types of tabs when you double-click on a placed component.

### 5.1.2.1 Real Components

In one sense of the word, all components found in Multisim are virtual. They are virtual representations of components like resistors, capacitors and transistors. Wired together and

simulated in Multisim, they will give you an idea of how such a circuit will function when prototyped.

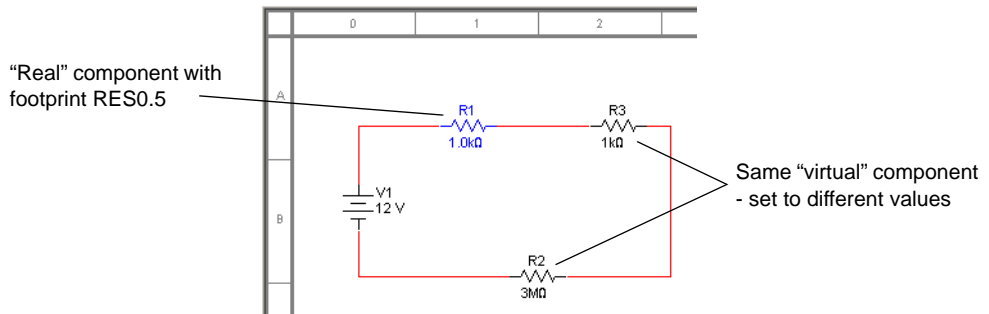

However, when a "real" component is referred to in this guide, it corresponds to a real, purchasable component with values that include footprints and package type for use in PCB layout programs, like Ultiboard.

"Virtual" components, however, give you a means to experiment with a specific component's parameters early in the design process. Once you have determined the desired parameters, you can replace the "virtual" component with a "real" component. Real components must be replaced in order to provide alternate values (e.g., to substitute a 1kOhm resistor for a 3MOhm resistor).

For real components, the tab looks like this:

Identifies the value information of the component being used.

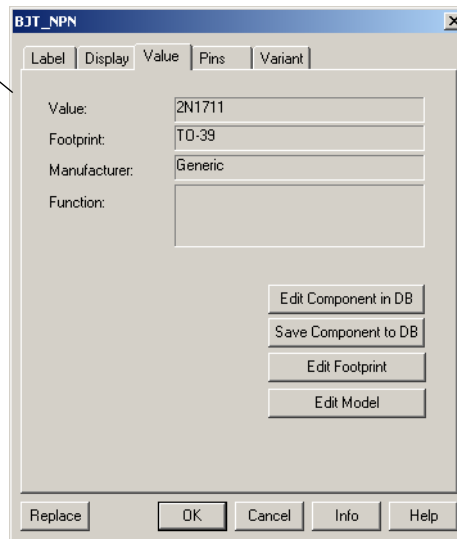

**Note** For virtual components, see "5.1.2.4 Virtual Components" on page 5-7.

- To edit the component in the database:
  1. Click on **Edit Component in DB**.
  2. Refer to “8.1 Introduction to Component Editing” on page 8-2.

### 5.1.2.2 Edit Model Dialog Box

You can edit the model of a selected component using the **Edit Model** dialog box.

- To edit the selected component’s model:
  1. Double-click the component to display its properties dialog box.
  2. Click **Edit Model** in the **Value** tab. The **Edit Model** dialog box appears.

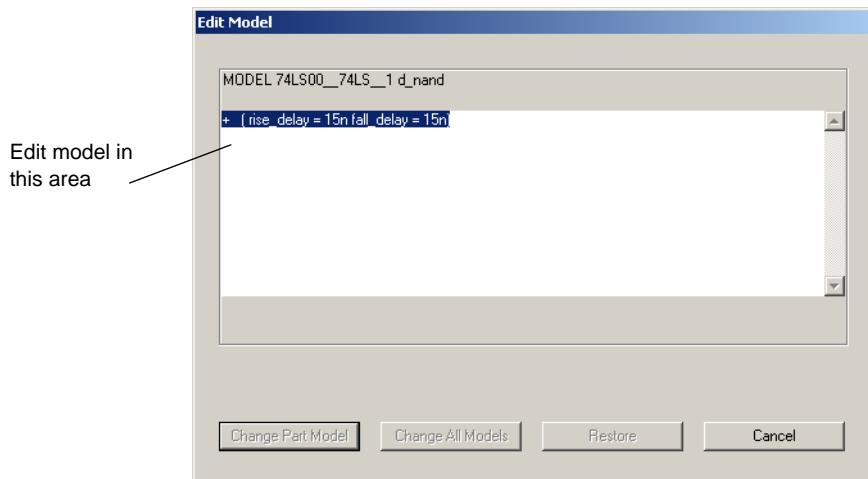

3. Edit the model in the area shown above.
4. Make a selection based on the following:
  - **Change Part Model**—changes the model information for the selected component only. The button becomes active when a change is made to the model information.
  - **Change All Models**—changes all models for the same part on the active workspace only, (i.e., not in the database). The button becomes active when a change is made to the model information.
  - **Restore**—restores the model to its original state. The button becomes active when a change is made to the model information.
  - **Cancel**—closes the window without making the changes.
5. To cancel your settings, click **Cancel**. To save your settings, click **OK**.

Reminder! Changes made here only apply to that particular component, not to all similar components on the schematic, or to the one in the database from which it was copied.

### 5.1.2.3 Edit Footprint Dialog Box

You can edit the footprint of a selected component using the **Edit Footprint** dialog box.

- To edit the selected component's footprint:
  1. Click on **Edit Footprint** in the component's **Value** tab. The **Edit Footprint** dialog box appears.

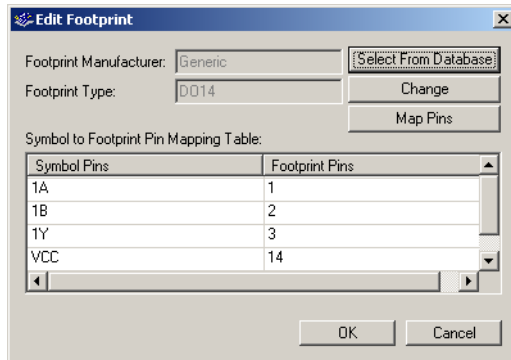

2. Click **Select From Database** to display the **Select a Footprint** dialog box. Select the desired footprint. Refer to “8.8.1 Select a Footprint dialog box” on page 8-52 for details on using the **Select a Footprint** dialog box.

*Or*

Click **Change** to display the **Change Footprint** dialog box.

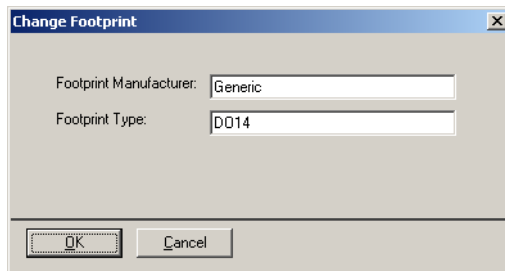

Enter the desired **Footprint Manufacturer** and **Footprint Type** and click **OK** to return to the **Edit Footprint** dialog box.

3. To cancel your settings, click **Cancel**. To save your settings, click **OK**.

**Note** Click **Map Pins** to display the **Advanced Pin Mapping** dialog. See “8.8.3 Advanced Pin Mapping Dialog” on page 8-58 for details.

### 5.1.2.4 Virtual Components

For virtual components, whose value can be set manually, the tab looks similar to this:

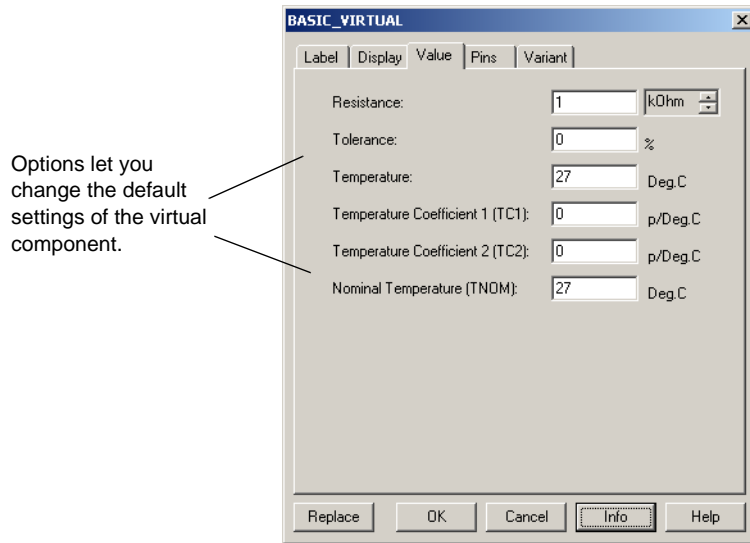

You can modify any of these fields. To cancel your changes, click **Cancel**. To save your changes, click **OK**.

Virtual components are not real; that is, you could not go to a supplier and purchase them. They have a symbol and a model, but no footprint. They are provided for your convenience to allow you to simulate “what-if” scenarios. Multisim treats them slightly differently from real components. By default, virtual components are shown in a different color from that of real components on your schematic. This is to remind you that, since they are not real, these components will not be exported to PCB layout software.

Virtual parts include all sources, virtual resistor/capacitor/inductor parts, and numerous others. Virtual parts also include other “ideal” devices intended to provide theoretical equivalents of, for example, the perfect opamp.

## 5.1.3 Controlling How a Placed Component is Used in Analyses

For some components, you can determine how they are to be used in any analyses you might perform on the circuit. These components offer additional information in the Value tab.

- To control how the component is used in analyses:
  1. Double-click on the component. The “properties” dialog box for the component appears.
  2. Click the **Value** tab:

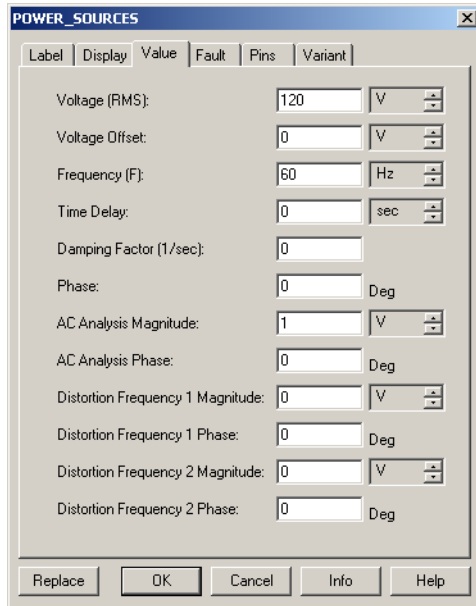

3. Modify the settings as desired.
4. To cancel your changes, click **Cancel**. To save your changes, click **OK**.

## 5.2 The Spreadsheet View



The **Spreadsheet View** allows fast advanced viewing and editing of parameters including component details such as footprints, Reference Designators, attributes and design constraints. The **Spreadsheet View** provides a global perspective on object properties.

### 5.2.1 Spreadsheet View Results Tab

If you select **Result Pane** in the **ERC Options** tab of the **Electrical Rules Check** dialog box, the **Results** tab will display the results of Electrical Rules Checks (ERCs). For details, refer to “5.4 Electrical Rules Checking” on page 5-34 and “Result Pane” on page 5-35.

The results on an **Edit/Find** command will also appear in the **Results** tab. See “4.8 Finding Components in Your Circuit” on page 4-32 for details.

#### Pop-up from the Results tab

- To use the pop-up menu on the results of an **ERC** or **Find**:
  1. Right-click on the desired result to display the pop-up menu.

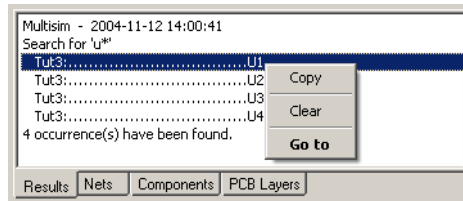

2. Select one of:
  - **Copy** — copies entire contents of **Results** tab onto clipboard.
  - **Clear** — clears content of **Results** tab.
  - **Go to** — selects the item on the workspace.

## 5.2.2 Spreadsheet View Nets Tab

Column	Description
Net	The net's name.
Sheet	The filename of sheet on which the net is found.
Color	Net's color. "Default" is based on the color scheme selected in the <b>Circuit</b> tab of the <b>Sheet Properties</b> dialog box. Click to display a <b>Color</b> palette and select the desired color.
Trace Width	Width of the traces after export to PCB layout. Unit of measure is set in Ultiboard.
Trace Width Min	Trace's minimum allowable width. Unit of measure is set in Ultiboard. Select desired row and then click in the field to edit.
Trace Width Max	Trace's maximum allowable width. Unit of measure is set in Ultiboard. Select desired row and then click in the field to edit.
Trace Length Min	Trace's minimum allowable length. Unit of measure is set in Ultiboard. Select desired row and then click in the field to edit.
Trace Length Max	Trace's maximum allowable length. Unit of measure is set in Ultiboard. Select desired row and then click in the field to edit.
Trace to Trace	Minimum allowable space between traces in the net and traces in any other net on the PCB (printed circuit board). Unit of measure is set in Ultiboard. Click and type to make changes.
Trace to Pad	Minimum allowable space between traces in the net and pads on any other net on the PCB. Unit of measure is set in Ultiboard. Click and type to make changes.
Trace to Via	Minimum allowable space between traces in the net and vias on any other net on the PCB. Unit of measure is set in Ultiboard. Click and type to make changes.
Trace to Copper Area	Minimum allowable space between traces in the net and copper areas on the PCB. Unit of measure is set in Ultiboard. Click and type to make changes.
Routing Layer	The copper layer where the net will be placed. Click to display a drop-down list with the available selections. This drop-down is populated based on the selections made in the <b>PCB</b> tab of the <b>Sheet Properties</b> dialog box in the <b>Number of Copper Layers</b> field. For details on this tab, see "3.4.2.5 Sheet Properties - PCB Tab" on page 3-32.



Column	Description
Net Group	Click in this field to enter a group for a net. This group can be used in Ultiboard 7 to keep nets together during the PCB layout process.
Lock PCB Settings	If enabled, prevents changes to parameters that effect layout of net on the PCB. Click to toggle between Yes and No.
IC Initial Condition	The net's initial condition for Transient Analysis in Multisim. For details, see "11.6 Transient Analysis" on page 11-38.
NODESET	The net's initial condition for DC Operating Point Analysis in Multisim. For details, see "11.4 DC Operating Point Analysis" on page 11-31.
Type	Type of net. Can be Power, Ground or Signal.
Net Specific Setting	If "Use Net-specific Setting" in the <b>Sheet Properties</b> dialog box is enabled, (see, "3.4.2.1 Sheet Properties - Circuit Tab" on page 3-26), the setting for the selected net is entered here. Choices are Show Net Name or Hide Net Name.

## 5.2.3 Spreadsheet View Components Tab

Column	Description
RefDes	The component's unique identifier.
Sheet	The sheet on which the component appears.
Section	The section of a multi-section component such as a quad NAND gate.
Section Name	The name of the section of a multi-section component.
Family	The component's database family.
Value	The component's value, for example, 5 V for a battery; or the component's model, for example, 2N2222A. Double-click to edit the component's model.
Manufacturer	The component's manufacturer; either "Generic" or a specific company.
Footprint	The physical footprint of the component. Click on the field to change the footprint. For details, see "8.8 Editing a Component's Footprint" on page 8-51.

Column	Description
Description	The component's description.
Label	The component's user-defined label. Click on the field and type in desired text. Can also be entered in the Label tab in the component's properties dialog box. For details, see "4.9.1 Modifying Component Labels and Attributes" on page 4-34.
Coordinate X/Y	The position of the component on the workspace. This field is read-only and changes as the component is moved on the workspace.
Rotation	Click to display a drop-down list of the selections available to rotate the component. "Unrotated" is the component's original position. Other selections are: Rotated 90 (90 degrees clockwise from original position), Rotated 180 (180 degrees clockwise from original position), Rotated -90 (90 degrees counter-clockwise from original position). You can also rotate a component by right-clicking on it in the workspace. For details, see "3.3 Using the Pop-up Menus" on page 3-12.
Flip	Click to display a drop-down list of the selections available to flip the component. "Unflipped" is the component's original position. Other selections are: Flipped X (horizontal flip from original position), Flipped Y (vertical flip from original position), Flipped XY (a horizontal and a vertical flip from original position). You can also flip a component by right-clicking on it in the workspace. For details, see "3.3 Using the Pop-up Menus" on page 3-12.
Color	Component's color. "Default" is based on the color scheme selected in the <b>Circuit</b> tab of the <b>Sheet Properties</b> dialog box. Click to display a <b>Color</b> palette and select the desired color.
Spacing	Minimum distance between the component and another component when using the shove option in Ultiboard. Unit of measure is set in the <b>PCB</b> tab of the <b>Sheet Properties</b> dialog box. Click to enter new data.
Group	Click in this field to enter a group for a component. This group can be used in Ultiboard to keep components together during the PCB layout process.
Pin Swapping	If enabled, allows pins for like-components to be swapped during the PCB layout process. Click to toggle between Yes and No. This feature is not available in all versions of Multisim.
Gate Swapping	If enabled, allows gates with same functionality, such as two NAND gates to be swapped during PCB layout process. Click to toggle between Yes and No. This feature is not available in all versions of Multisim.
Lock PCB Settings	If enabled, prevents changes to parameters that effect layout of components on the PCB. Click to toggle between Yes and No.







Column	Description
VCC	Supply voltage. If not blank, indicates that the part has the corresponding input. You may choose to assign a netname from those power and ground nets that are placed on the schematic.
VDD	Supply voltage. If not blank, indicates that the part has the corresponding input. You may choose to assign a netname from those power and ground nets that are placed on the schematic.
VEE	Supply voltage. If not blank, indicates that the part has the corresponding input. You may choose to assign a netname from those power and ground nets that are placed on the schematic.
VPP	Supply voltage. If not blank, indicates that the part has the corresponding input. You may choose to assign a netname from those power and ground nets that are placed on the schematic.
GND	Ground. If not blank, indicates that the part has the corresponding input. You may choose to assign a netname from those power and ground nets that are placed on the schematic.
VSS	Usually ground, but for some components can be a negative supply voltage. If not blank, indicates that the part has the corresponding input. You may choose to assign a netname from those power and ground nets that are placed on the schematic.
Variant	Displays a checkbox for each available variant. Enable the checkbox for each variant of the circuit that you wish the component to be included in. For details on variants, see "6.5 Variants" on page 6-34.



## 5.2.4 Spreadsheet View PCB Layers Tab

Column	Description
Layer	The contents of this column are set from the <b>PCB</b> tab of the <b>Sheet Properties</b> dialog box. For details, see “3.4.2.5 Sheet Properties - PCB Tab” on page 3-32.
Routable	When enabled, the layer can be routed during the PCB layout process. Click to toggle between Yes and No.
Type	Defines the type of layer. Double-click to display a drop-down list and choose from Signal, Power or Ground.

## 5.2.5 Spreadsheet View Buttons

The following buttons are available in the **Spreadsheet View**.

Button	Description
	<b>Find and Select</b> button. Finds and highlights the selected component or net on the workspace. This feature is not available in all versions of Multisim.
	<b>Export to Textfile</b> button. Displays a standard Windows Save dialog where you save the selection as a textfile. This feature is not available in all versions of Multisim.
	<b>Export to CSV File</b> button. Displays a standard Windows Save dialog where you save the selection as a file with comma-separated values. This feature is not available in all versions of Multisim.
	<b>Export to Excel</b> button. Click to open a Microsoft® Excel spreadsheet with the selected data displayed. (You must have Excel installed to use this function). This feature is not available in all versions of Multisim.
	<b>Sort Ascending</b> button. Sorts the selected column in ascending order.
	<b>Sort Descending</b> button. Sorts the selected column in descending order.
	<b>Print</b> button. Prints the data in the selected tab. This feature is not available in all versions of Multisim.

Button	Description
	<b>Copy</b> button. Copies the selection to the clipboard.
	<b>All</b> button. Displays all of the netlists or components (depending on the selected tab) from all sheets, multi-pages, subcircuits and hierarchical blocks in the current design.
	<b>Replace Selected Components</b> button. Before using, select the desired component(s) in the circuit window to be replaced. Invokes the Select a Component browser from which you can select a new component. Click OK to replace the old component(s) with the selected new one.

### 5.3 Title Block Editor



The **Title Block Editor** is a specialized graphics editor that allows you to create or modify a title block. For example, you can insert and position title block data, change font properties and place or move graphic objects.

The **Title Block Editor** looks like this:

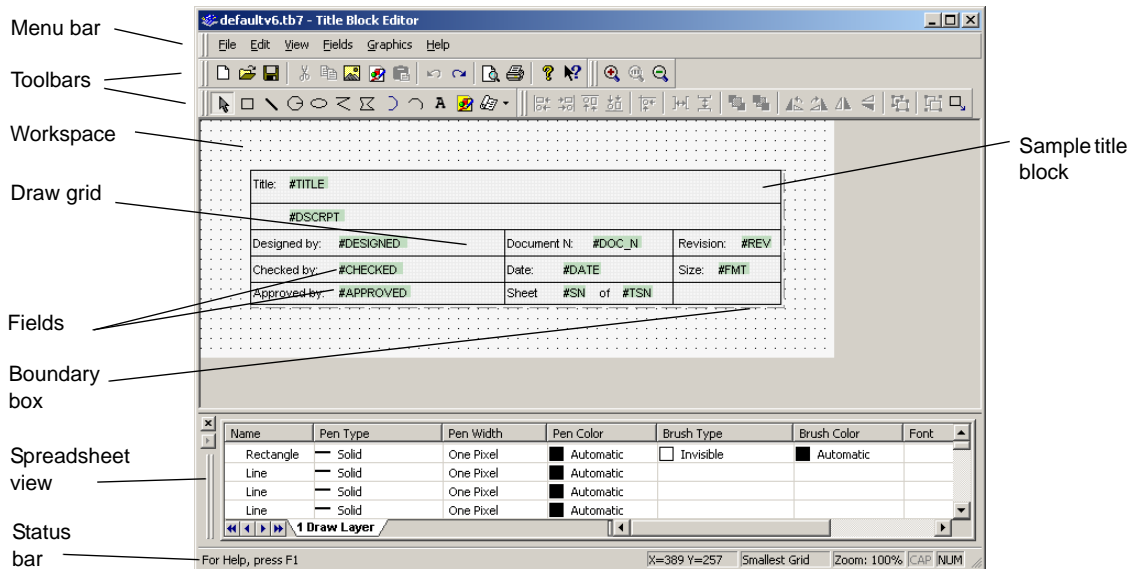

The **Title Block Editor** consists of:

- the **menu bar**, which contains the menus with their associated commands.
- the **toolbars**, which give quick access to the most commonly-used tools.
- the **workspace**, which is where you build or modify your title blocks. The **Draw Grid** aids in the placement of graphic elements inside the **Boundary Box**.
- the **Spreadsheet View**, which is where you find and edit various title block parameters.
- the **status line**, which gives information on the currently selected object or action.

➤ To edit a title block that is already in your circuit:

1. Right click on the desired title block and select **Edit Title Block** from the pop-up. The **Title Block Editor** appears with the selected title block loaded.

**Note** “In-Place Edit Mode” displays at the bottom of the dialog box when the **Title Block Editor** is launched using the method described above. Changes will apply to the selected title block only.

2. Edit the title block as described in:

- “5.3.1 Enter Text Dialog Box” on page 5-17
- “5.3.2 Placing Fields” on page 5-18.
- “5.3.3 Title Block Editor Spreadsheet View” on page 5-21
- “5.3.4 Title Block Editor Menus” on page 5-22
- “5.3.5 Toolbars” on page 5-29

3. Select **File/Exit**. The following dialog box appears:

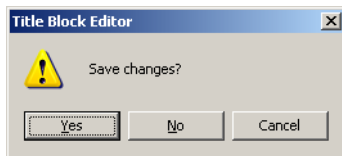

4. Click **Yes**. The **Title Block Editor** closes and you are returned to the main Multisim workspace. The changes are reflected in the title block.

➤ To edit a title block that is stored in the **Title Block** folder, or create a new title block:

1. Select **Tools/Title Block Editor**. The **Title Block Editor** appears with a new un-named title block.

2. If you wish to create a new title block, you may start working from here.

*Or*

If you wish to edit an existing title block, select **File/Open**, navigate to the **Titleblocks** folder, select the desired title block and click **Open**.

3. Edit the title block using the menus and toolbars as described in the following sections.

4. Select **File/Exit** and click **Yes** when prompted to save your changes. If this is a new title block, a standard **Save As** dialog box appears. Enter the desired filepath and filename, and click **Save**.

If it is an existing title block the changes are saved and the **Title Block Editor** closes.

The next sections describe the **Title Block Editor** functionality in more detail.

## 5.3.1 Enter Text Dialog Box

The **Enter Text** dialog box is used to enter and format text and place it on the title block.

- To enter text on a title block:

1. Select **Graphics/Text**.

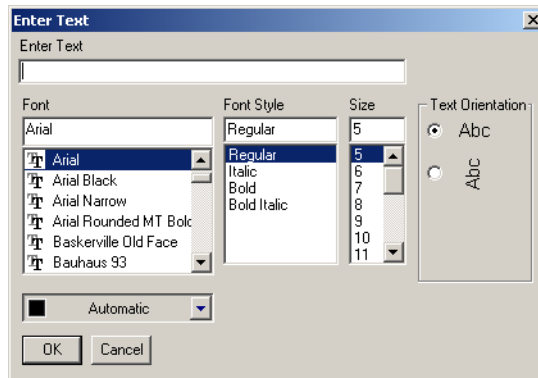

2. Type the desired text in the **Enter Text** field.
3. Change the formatting of the text as desired:
  - **Font** field — select desired font from the list or type in.
  - **Font Style** field — select desired style from the list.
  - **Size** field — select desired size from the list or type in.
  - **Text Orientation** box — select either horizontal or vertical orientation.
  - **Automatic** drop-down list — optionally, select a new color from the pop-up that appears when you click on the down-arrow.
4. Click **OK**, move the cursor to the desired location and click the mouse to place the text.

## 5.3.2 Placing Fields

Fields are placeholders for text that appears in the title block on your circuit schematic.

**Note** The actual text that appears in these fields is entered in the **Title Block** dialog box, which is accessed from Multisim's main screen.

For a field's text to appear in the title block in Multisim, you must first place the field for that text in the title block using the **Title Block Editor**.

➤ To place a field on the title block:

1. Select the desired field type from the **Field** menu (for example, **Revision**).

*Or*

Click on the **Text Field** button in the **Draw Tools** toolbar and select the desired field type from the pop-up that displays (for example, **Revision**).

The **Enter Title Block Attribute** dialog box displays the code for the selected field in the **Title Block Attribute** field. (Since we selected **Revision** in this example, #REV appears).

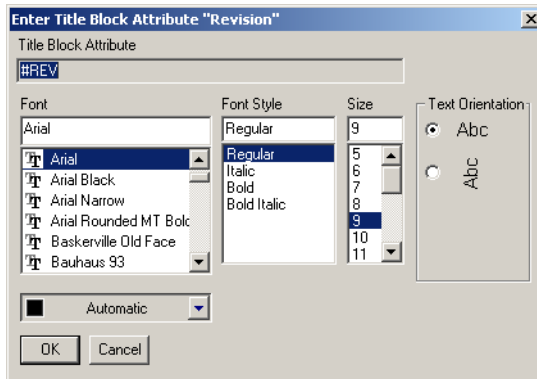

**Note** For a list of all field codes, see “5.3.2.1 Field Codes” on page 5-20.

2. Change the formatting of the text as desired:

- **Font** field — select desired font from the list or type in.
- **Font Style** field — select desired style from the list.
- **Size** field — select desired size from the list or type in.
- **Text Orientation** box — select either horizontal or vertical orientation.
- **Automatic** drop-down — optionally, select a new color from the pop-up that appears when you click on the down-arrow.



3. Click **OK**, move the cursor to the desired location and click the mouse to place the field.

Electronics Workbench		
Title: #TITLE		Electronics WORKBENCH design solutions for every desktop
#DSCRIPT		
Designed by: #DESIGNED	Document No: #DOC_N	Revision: #REV
Checked by: #CHECKED	Date: #DATE	Size: #FMT
Approved by: #APPROVED	Sheet #SN of #TSN	

Code for placed  
Revision field.

All placed fields  
appear in green  
highlighting.

Placed text is not  
highlighted.

4. After completing any other edits to the title block, select **File/Exit** and save the changes when prompted. You are returned to the main Multisim screen, where the field code (#REV) has been replaced by text. This text is set in the **Revision** field of the **Title Block** dialog box, which is found in the main Multisim application. For details, see “4.9.3.1 Entering the Title Block Contents” on page 4-37.

Electronics Workbench		
Title: TUT3		Electronics WORKBENCH design solutions for every desktop
Project 1		
Designed by: John	Document No: 0001	Revision: 1.0
Checked by:	Date: Feb 11, 2003	Size: A
Approved by:	Sheet 1 of 1	

Field code has been  
replaced by text.

**Caution** The width of a *field* as displayed in the **Title Block Editor** is not the same as the actual *text* that is placed in that field using the **Title Block** dialog box (see “4.9.3.1 Entering the Title Block Contents” on page 4-37). Space used is also dependant on the font size. If after placing the actual text in the title block using the **Title Block** dialog box, you find that text overlaps, you must either adjust the text, or return to the **Title Block Editor** and adjust the positioning of the fields.

**Note** If text in the **Title Block** dialog box does not appear in your title block, it is because the field corresponding to that text was not placed in the title block using the **Title Block Editor**.

### 5.3.2.1 Field Codes

The available field codes are described below:

Field	Code
Title	#TITLE
Description	#DSCRPT
Designed By	#DESIGNED
Checked By	#CHECKED
Approved By	#APPROVED
Document Number	#DOC_N
Date	#DATE
Current Sheet Number	#SN
Total Sheet Numbers	#TSN
Revision	#REV
Format	#FMT
Custom Field 1	#CUSTOM_1
Custom Field 2	#CUSTOM_2
Custom Field 3	#CUSTOM_3
Custom Field 4	#CUSTOM_4
Custom Field 5	#CUSTOM_5

### 5.3.3 Title Block Editor Spreadsheet View

The **Spreadsheet View** is where you find and edit various title block parameters. When you select an item on the workspace, it is highlighted in the spreadsheet, and vice versa. If you make a change to an item in the spreadsheet, it is reflected on the title block in the workspace.

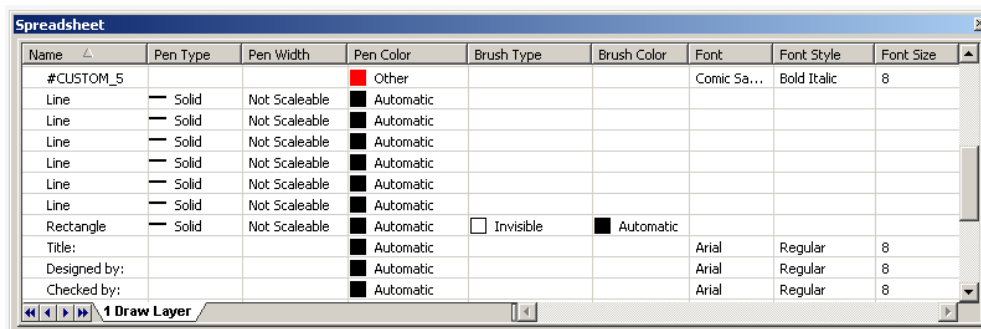

Column	Description
Name	The type of graphic element.
Pen Type	The appearance of lines for graphics elements, excluding placed text. Select the desired row and click to display a list of pen types. Choices are: Solid; Dash; Dot; Dash-Dot; Dash-Dot-Dot; Invisible; Solid Inside Frame.
Pen Width	The width of the lines in graphic elements, excluding placed text. Select the desired row and click to display a list of pen types. Choices are: Not Scaleable; One Pixel; Two Pixels; Three Pixels; Four Pixels; Five Pixels.
Pen Color	The color of lines for graphic elements, including placed text. Select the desired row and click to display a color palette.
Brush Type	The style of the fill in elements such as polygons, that have a fill. Select the desired row and click to display a list of fill types. Choices are: Solid; Invisible; Horizontal; Vertical; Diagonal Downward; Diagonal Upward; Cross; Diagonal Cross.
Brush Color	The color of the fill in elements such as polygons, that have a fill. Select the desired row and click to display a color palette.
Font	The font name, active for placed text elements only. Double click to display a list of fonts.

Column	Description
Font Style	The font style, active for placed text elements only. Select the desired row and click to display a list. Choices are: Regular; Italic; Bold; Bold Italic.
Font Size	The font size, active for placed text elements only. Select the desired row and click to display a list of sizes.

**Note** If objects are grouped using **Edit/Group**, their distinct names and properties will no longer appear in the **Name** column. The name for any grouped object will appear as “Group”.

## 5.3.4 Title Block Editor Menus

The **Title Block Editor** menus contain all the commands necessary to create and edit title blocks.

### 5.3.4.1 File Menu

The following selections are available under the **File** menu:

Menu	Use
New	Opens a new untitled document in the Title Block Editor. If you already have one open, it will close first, after prompting you to save any changes.
Open	Opens an existing document in the Title Block Editor. If you already have one open, it will close first, after prompting you to save any changes.
Save	Saves changes to the active document.
Save As	Opens the standard Windows “Save As” dialog box where you can save the active document under a new or existing name.
Print Setup	Opens the standard Windows “Print Setup” dialog box where you can enter the desired parameters for your printer.
Print Preview	Opens the Print Preview dialog box, which shows the title block in the active document with the best fit to the page. There are no other sizes available.
Print	Opens the standard Windows “Print” dialog box where you can enter the desired printing properties and print the title block. The title block is printed with the best fit to the page. There are no other magnifications available for printing the title block.

Menu	Use
Exit	Closes the Title Block Editor and returns you to the main Multisim screen. Before exiting, you are prompted to save any changes to the active document.

### 5.3.4.2 Edit Menu

The following selections are available under the **Edit** menu:

Menu	Use
Undo	Undoes the previous action.
Redo	Undoes the previous “undo” action.
Cut	Removes the selected element(s) from the workspace and places them on the clipboard.
Copy	Places a copy of the selected element(s) on the clipboard.
Paste	Places a copy of the element(s) on the clipboard on the workspace at the cursor’s location.
Delete	Removes the selected element(s) from the workspace. They are <i>not</i> placed on the clipboard.
Copy As Picture	Copies the title block on the workspace as a metafile.
Copy As Bitmap	Copies the title block on the workspace as a bitmap image.
Select All	Selects all of the elements on the workspace.
Flip Horizontal	Flips the selected element(s) horizontally.
Flip Vertical	Flips the selected element(s) vertically.
Rotate 90 Clockwise	Rotates the selected element(s) 90 degrees clockwise.
Rotate 90 Counter CW	Rotates the selected element(s) 90 degrees counter-clockwise.

<b>Menu</b>	<b>Use</b>
Snap To Grid	Snaps the selected element(s) to the Draw Grid that is found within the title block's boundary box.
Group	Places selected elements in one group.
UnGroup	Returns an element that was made using the Group command, back to its individual elements.
Bring To Front	Brings selected element(s) to the foreground on the workspace. Other element(s) appear behind them.
Send To Back	Sends selected element(s) to the background on the workspace. Other elements appear in front of them.
Resize Boundary Box	Places a cursor at the lower-right side of the boundary box. Drag it to the desired location to resize the boundary box. You cannot make the boundary box smaller than the elements that it contains.

### 5.3.4.3 View Menu

The following selections are available under the **View** menu:

<b>Menu</b>	<b>Use</b>
Toolbars	Toggles the following toolbars on and off: Standard Toolbar; Zoom Toolbar; Draw Tools; Drawing Toolbar.
Spreadsheet	Toggles the spreadsheet view on and off. For details, see "5.3.3 Title Block Editor Spreadsheet View" on page 5-21.
Status Bar	Toggles the Status bar at the bottom of the screen on and off.
Show Draw Grid	Toggles the Draw Grid, which displays inside the Boundary Box, on and off.
Draw Grid Size	Sets the size of the Draw Grid, which displays inside the Boundary Box. The choices are: No Grid (select if you wish to draw an element that does not snap to the grid); Smallest Grid; Small Grid; Regular Grid; Large Grid.
Zoom In	Magnifies the element(s) in the workspace.
Zoom Out	Reduces the viewing size of the element(s) in the workspace.

Menu	Use
Zoom 100%	Displays the items in the workspace at their normal viewing size. This is the size that they will be displayed at in Multisim. When the Title Block Editor first opens, the magnification is set to 100%.
Center By Mouse	When viewing the workspace at high magnifications, you can use this command to center the image on the workspace. Select Center By Mouse and then click on the spot that you would like to be placed at the center of the workspace.
Redraw	Redraws all elements in the workspace.

### 5.3.4.4 Fields Menu

Fields are placeholders for text that appear in the title block on Multisim's main screen. For details, see "5.3.2 Placing Fields" on page 5-18.

The following selections are available under the **Fields** menu.

Menu	Use
Select	Lets you select specific element(s) on the workspace.
Title	Displays the Enter Title Block Attribute dialog box, where you enter formatting information for the Title field (#TITLE) and click OK to place the field on the title block.
Description	Displays the Enter Title Block Attribute dialog box, where you enter formatting information for the Description field (#DESCRPT) and click OK to place the field on the title block.
Designed By	Displays the Enter Title Block Attribute dialog box, where you enter formatting information for the Designed By field (#DESIGNED) and click OK to place the field on the title block.
Checked By	Displays the Enter Title Block Attribute dialog box, where you enter formatting information for the Checked By field (#CHECKED) and click OK to place the field on the title block.
Approved By	Displays the Enter Title Block Attribute dialog box, where you enter formatting information for the Approved By field (#APPROVED) and click OK to place the field on the title block.
Document Number	Displays the Enter Title Block Attribute dialog box, where you enter formatting information for the Document Number field (#DOC_N) and click OK to place the field on the title block.

<b>Menu</b>	<b>Use</b>
Date	Displays the Enter Title Block Attribute dialog box, where you enter formatting information for the Date field (#DATE) and click OK to place the field on the title block.
Current Sheet Number	Displays the Enter Title Block Attribute dialog box, where you enter formatting information for the Current Sheet Number field (#SN) and click OK to place the field on the title block.
Total Sheet Numbers	Displays the Enter Title Block Attribute dialog box, where you enter formatting information for the Total Sheet Numbers field (#TSN) and click OK to place the field on the title block.
Revision	Displays the Enter Title Block Attribute dialog box, where you enter formatting information for the Revision field (#REV) and click OK to place the field on the title block.
Format	Displays the Enter Title Block Attribute dialog box, where you enter formatting information for the Format field (#FMT) and click OK to place the field on the title block.
Custom Field 1	Displays the Enter Title Block Attribute dialog box, where you enter formatting information for Custom Field 1 (#CUSTOM_1) and click OK to place the field on the title block.
Custom Field 2	Displays the Enter Title Block Attribute dialog box, where you enter formatting information for Custom Field 2 (#CUSTOM_2) and click OK to place the field on the title block.
Custom Field 3	Displays the Enter Title Block Attribute dialog box, where you enter formatting information for Custom Field 3 (#CUSTOM_3) and click OK to place the field on the title block.
Custom Field 4	Displays the Enter Title Block Attribute dialog box, where you enter formatting information for Custom Field 4 (#CUSTOM_4) and click OK to place the field on the title block.
Custom Field 5	Displays the Enter Title Block Attribute dialog box, where you enter formatting information for Custom Field 5 (#CUSTOM_5) and click OK to place the field on the title block.



### 5.3.4.5 Graphics Menu

The following selections are available under the **Graphics** menu:

Menu	Use
Text	Displays the Enter Text dialog box where you enter and format text to be placed on the workspace. For details, see “5.3.1 Enter Text Dialog Box” on page 5-17.
Line	Draws a line on the workspace.
Multiline	Draws a multiline on the workspace.
Half Ellipse Arc	Places half of an ellipse on the workspace. Click once at the desired starting point and click again where you wish the diameter of the ellipse to end. As you move the cursor, a dotted outline of the ellipse appears. Click again to place the outer point of the arc at the desired location.
Segment Arc	Places an arc on the workspace. Click once to place the center point of the arc, click again to place the outer diameter point. As you move the cursor, a dotted outline of the arc appears. Now move the cursor and click to place the arc's end point.
Bezier	Places a bezier curve on the workspace. Click to place the start of the curve, then move the cursor on the workspace. As you move the cursor, a dotted outline of the bezier curve appears. Click to place the end point of the bezier, then move and click the cursor twice more to form the final shape of the bezier.
Rectangle	Places a rectangle on the workspace.
Circle	Places a circle on the workspace. Click to place the center of the circle, then move the cursor on the workspace. As you move the cursor, a dotted outline of the circle appears. When the circle is the desired shape and size, click to place it on the workspace.
Ellipse	Places an ellipse on the workspace. Click to place the center of the ellipse, then move the cursor on the workspace. As you move the cursor, a dotted outline of the ellipse appears. When the ellipse is the desired shape and size, click to place it on the workspace.
Polygon	Places a polygon on the workspace.
Bitmap	Places a bitmap image on the workspace. Click to display a standard Windows “Open” dialog box, where you can select the desired bitmap.

### 5.3.4.6 Tools Menu

The following selection is available under the **Tools** menu:

Menu	Use
Customize	Displays the Customize dialog box. For details, see “3.6 Customizing the Interface” on page 3-37.

### 5.3.4.7 Help Menu

The following selections are available under the **Help** menu:

Menu	Use
Help Topics	Displays the helpfile.
About Title Block Editor	Displays a splash dialog with information about the Title Block Editor.

### 5.3.4.8 Pop-up Menus

Depending on where you right-click in the **Title Block Editor**, different context-sensitive pop-up menus appear.

Right-clicking on the menu/toolbar area displays a pop-up which allows you to toggle the following toolbars on and off: Standard Toolbar; Zoom Toolbar; Draw Tools; Drawing Toolbar. It also allows you to display the **Customize** dialog box.

Right-clicking in the *workspace* displays a pop-up that contains: Cut; Copy; Paste; Show Draw Grid; Draw Grid Size; Snap To Grid; Flip Horizontal; Flip Vertical; Rotate 90 Clockwise; Rotate 90 Counter CW. For details on these, see “5.3.4.2 Edit Menu” on page 5-23. If you do not right-click on a specific item in the workspace, then items in the pop-up will be greyed-out.









## 5.3.5 Toolbars





The toolbars give access to the most commonly-used tools in the **Title Block Editor**.

### 5.3.5.1 Standard Toolbar



The buttons in the **Standard** toolbar are described below:



Button	Description
	New button. Opens a new untitled document in the Title Block Editor. If you already have one open, it will close first, after prompting you to save any changes.
	Open button. Opens an existing document in the Title Block Editor. If you already have one open, it will close first, after prompting you to save any changes.
	Save button. Saves changes to the active document.
	Cut button. Removes the selected element(s) from the workspace and places them on the clipboard.
	Copy button. Places a copy of the selected element(s) on the clipboard.
	Copy As Picture button. Copies the title block on the workspace as a metafile.
	Copy As Bitmap button. Copies the title block on the workspace as a bitmap image.
	Paste button. Places a copy of the element(s) on the clipboard on the workspace at the cursor's location.

Button	Description
	Undo button. Undoes the previous action.
	Redo button. Redoes the previous “undo” action.
	Print Preview button. Opens the Print Preview dialog box, which shows the title block in the active document with the best fit to the page. There are no other sizes available.
	Print button. Opens the standard Windows “Print” dialog box, where you can enter the desired printing properties and print the title block. The title block is printed with the best fit to the page. There are no other magnifications available for printing the title block.
	About Title Block Editor button. Displays an “About” box with information about the Title Block Editor.

### 5.3.5.2 Zoom Toolbar









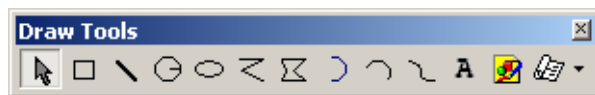



The buttons in the **Zoom** toolbar are described below:



Button	Description
	Zoom In button. Magnifies the elements on the workspace.
	Zoom 100% button. Displays the items in the workspace at their normal viewing size. This is the size that they will be displayed at in Multisim. When the Title Block Editor first opens, the magnification is set to 100%.
	Zoom Out button. Reduces the viewing size of the element(s) on the workspace.

### 5.3.5.3 Draw Tools Toolbar



The buttons in the **Draw Tools** toolbar are described below:





Button	Description
	Select button. Use to select element(s) on the workspace by clicking and dragging the mouse.
	Rectangle button. Places a rectangle on the workspace.
	Line button. Places a line on the workspace.
	Circle button. Places a circle on the workspace. Click to place the center of the circle, then move the cursor on the workspace. As you move the cursor, a dotted outline of the circle appears. When the circle is the desired shape and size, click to place it on the workspace.
	Ellipse button. Places an ellipse on the workspace. Click to place the center of the ellipse, then move the cursor on the workspace. As you move the cursor, a dotted outline of the ellipse appears. When the ellipse is the desired shape and size, click to place it on the workspace.
	Multiline button. Places a multiline on the workspace.
	Polygon button. Places a polygon on the workspace.
	Half Ellipse Arc button. Places a half ellipse arc on the workspace.
	Segment Arc button. Places an arc on the workspace. Click once to place the center point of the arc, click again to place the out diameter point. As you move the cursor, a dotted outline of the arc appears. Now move the cursor and click to place the arc's end point.
	Bezier button. Places a bezier curve on the workspace.

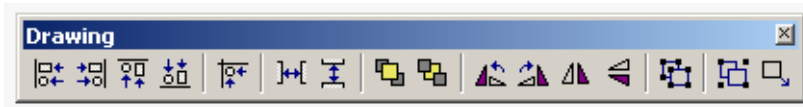











Button	Description
	Text button. Displays the Enter Text dialog box, where you enter and format text to be placed on the workspace. For details, see “5.3.1 Enter Text Dialog Box” on page 5-17.
	Bitmap button. Places a bitmap image on the workspace. Click to display a standard Windows “Open” dialog box, where you can select the desired bitmap.
	Text Field button. Select to enter formatting information for a specific field. Displays a drop-down list with these choices: Title; Description; Designed By; Checked By; Approved By; Document Number; Date; Current Sheet Number; Total Sheet Numbers; Revision; Format; Custom Field 1; Custom Field 2; Custom Field 3; Custom Field 4; Custom Field 5. When a choice is made, the Enter Title Block Attribute dialog box displays. For details, see “5.3.2 Placing Fields” on page 5-18.

### 5.3.5.4 Drawing Toolbar



The buttons on the **Drawing** toolbar are described below:

Button	Description
	Align Left button. Moves selected objects horizontally so that their left sides line up with the left side of the left-most object. At least two objects must be selected to enable this button.
	Align Right button. Moves selected objects horizontally so that their right sides line up with the right side of the right-most object. At least two objects must be selected to enable this button.
	Align Top button. Moves selected objects vertically so that their top sides line up with the top side of the top-most object. At least two objects must be selected to enable this button.
	Align Bottom button. Moves the selected objects vertically so that their bottom sides line up with the bottom side of the bottom-most object. At least two objects must be selected to enable this button.

Button	Description
	Snap To Grid button. Snaps the selected element(s) to the Draw Grid that is found within the title block's boundary box.
	Distribute Horizontal button. Evenly spaces the selected objects horizontally. At least three objects must be selected to enable this button.
	Distribute Vertical button. Evenly spaces the selected objects vertically. At least three objects must be selected to enable this button.
	Bring To Front button. Brings selected element(s) to the foreground on the workspace. Other element(s) appear behind them.
	Send To Back button. Sends selected element(s) to the background on the workspace. Other elements appear in front of them.
	Rotate 90 Counter CW button. Rotates the selected element(s) 90 degrees counter-clockwise.
	Rotate 90 Clockwise button. Rotates the selected element(s) 90 degrees clockwise.
	Flip Horizontal button. Flips the selected element(s) horizontally on the workspace.
	Flip Vertical button. Flips the selected element(s) vertically on the workspace.
	Ungroup button. Returns an element that was made using the Group command back to its individual elements.
	Group button. Places selected elements in one group.
	Resize Boundary Box button. Places a cursor at the lower-right side of the boundary box. Drag it to the desired location to resize the boundary box. You cannot make the boundary box smaller than the elements that it contains or smaller than is required for the pins that are attached to it.

## 5.4 Electrical Rules Checking

**Electrical Rules Checking** creates and displays a report detailing connection errors (such as an output pin connected to a power pin) and unconnected pins.

Once you have wired your circuit, you can check the connections for correctness based on the rules set up in the **Electrical Rules Check** dialog box.

Depending on your circuit, you may wish to have warnings issued if some types of connections are present, error messages for other connection types, and no warnings or errors for other connections. You control the type of connections that are reported when Electrical Rules Checking is done by setting up the rules in the grid found in the **ERC Rules** tab of the **Electrical Rules Check** dialog box.

ERC may be run over an entire design, or only across certain areas of a design. When an ERC is run, any anomalies are reported into a results pane at the bottom of the screen and the circuit is annotated with circular error markers. Clicking on an error will center and zoom on the error location.

- To run the electrical rules check:



1. Select **Tools/Electrical Rules Check** to display the **Electrical Rules Check** dialog box.
2. Set up the reporting options as described in “5.4.1 ERC Options Tab” on page 5-37 and “5.4.2 ERC Rules Tab” on page 5-39.
3. Set up the rules as described in “5.4.2 ERC Rules Tab” on page 5-39.
4. Click **OK**. The results display in the format selected in the **Output** box in the **ERC Options** tab.

In the following examples, a power pin has been connected to an output pin, which was defined as an error in the **ERC Rules** tab. All others pins have been left unconnected.

**Note** You can select whether or not to include specific pins in a component in the ERC. Refer to “5.4.3 Component’s Pins Tab” on page 5-41 for details.



## Result Pane

If you select **Result Pane** to display your output, errors and warnings are detailed in the **Results** tab of the **Spreadsheet View** as shown below.

Double-click on individual errors or warnings in the Results tab to zoom in on the workspace with the error or warning centered.

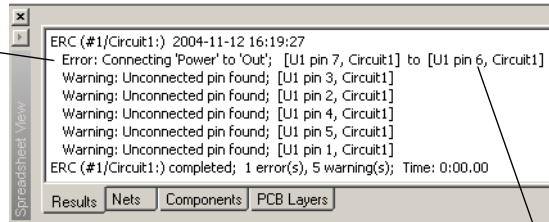
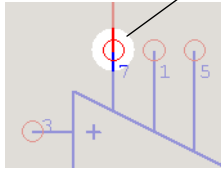

Double-click on the same error or warning to zoom to the other pin associated with the error or warning. (Does not apply to unconnected pins).

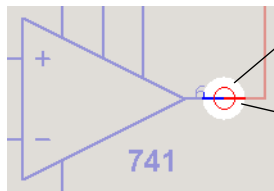

ERC Marker — Red circle indicates an error or warning.

## File

If you select **File** in the **Output** box, the results of the ERC are saved in the filepath and name that you enter in the **File** field.

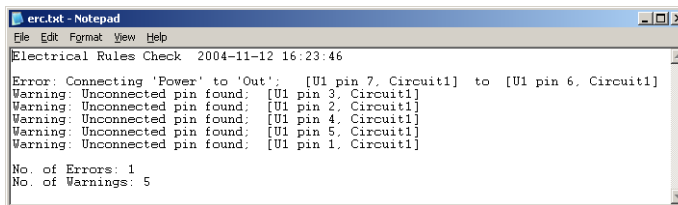

## List View

If you select **List View**, a report displays as shown below:

Total number of pins that were checked.

Total warnings issued.

Total error messages issued.

Details of errors and warnings appear in this area.

The screenshot shows the 'ERC Report (From Document: Circuit1)' dialog box. It has a title bar with standard window controls. Below the title bar are three summary statistics: 'Pins checked: 6', 'Total warnings: 5', and 'Total errors: 1'. Below these are four icons: a floppy disk (Save), a printer (Print), a magnifying glass (Preview), and a document with a blue arrow (Export to Excel). At the bottom is a table with the following data:

	First pin	First page	Second pin	Second page	Error/Warning
1	U1 pin 1	Circuit1			Warning: Unconnected pin found
2	U1 pin 2	Circuit1			Warning: Unconnected pin found
3	U1 pin 3	Circuit1			Warning: Unconnected pin found
4	U1 pin 4	Circuit1			Warning: Unconnected pin found
5	U1 pin 5	Circuit1			Warning: Unconnected pin found
6	U1 pin 7	Circuit1	U1 pin 6	Circuit1	Error: Connecting 'Power' to 'Out'

Use the buttons detailed below as required.

Save to a text file  
Send to a printer  
Print preview



To MS Excel App.

- **Save to a Text File** — click to save the data in the dialog box to a text file. A standard Windows save dialog box appears. Choose the desired filepath and click **Save**.
- **Send to a Printer** — click to display a standard Windows print dialog box. Choose the desired print options and click **OK**.
- **Print Preview** — click to display a Print Preview dialog box.
- **To MS Excel App** — click to open a Microsoft<sup>®</sup> Excel spreadsheet with the data from the dialog box displayed. (You must have Excel installed to use this function).

## 5.4.1 ERC Options Tab

This section describes how to set up Electrical Rule Check (ERC) options. To run an ERC, see “5.4 Electrical Rules Checking” on page 5-34.

- To set up the ERC options:



1. Select **Tools/Electrical Rules Check** to display the **Electrical Rules Check** dialog box and click on the **ERC Options** tab.

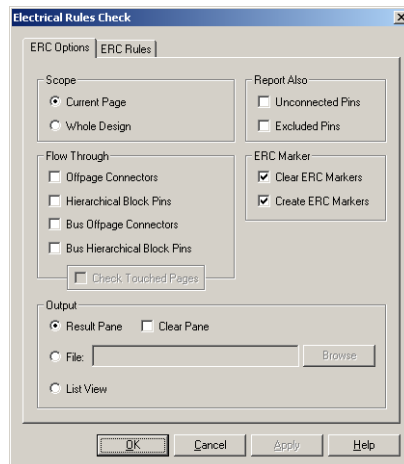

2. In the **Scope** box, select one of:
  - **Current Page** — to run the ERC on the page displayed and selected on your workspace.
  - **Whole Design** — to run the ERC on all subcircuits, hierarchical blocks and multi-pages associated with the current design.
3. In the **Flow Through** box, select as many of the following as desired:
  - **Offpage Connectors** — checks connections between pins connected through offpage connectors. Does not check any other pins on the associated multi-page unless **Check Touched Pages** is also selected.
  - **Hierarchical Block Pins** — checks connections between pins connected through HB/SC (hierarchical block or subcircuit) connectors. Does not check any other pins on the associated hierarchical block or subcircuit unless **Check Touched Pages** is also selected.
  - **Bus Offpage Connectors** — checks connections between pins connected to buses through bus offpage connectors. Does not check any other pins on the associated multi-page unless **Check Touched Pages** is also selected.
  - **Bus Hierarchical Block Pins** — checks connections between pins connected to buses through Bus HB/SC (hierarchical block or subcircuit) connectors. Does not check any other pins on the associated hierarchical block of subcircuit unless **Check Touched Pages** is also selected.

- **Check Touched Pages** — is active when one or more of the above are selected. When selected, ERC will check all connections on the associated multi-page, hierarchical block or subcircuit.
4. In the **Report Also** box, select the following as desired:
    - **Unconnected Pins** — checks for pins that are not connected to anything.
    - **Excluded Pins** — checks pins that have been excluded from ERC in the **Pins** tab of the component's properties dialog box. See "5.4.3 Component's Pins Tab" on page 5-41.
  5. In the **ERC Marker** box, select the following as desired:
    - **Clear ERC Markers** — clears existing ERC markers (red circles indicating errors and warnings) from the workspace when you run the ERC. To clear ERC markers *without* running an ERC, see "5.4.1.1 Clearing ERC Markers" on page 5-38.
    - **Create ERC Markers** — places red circles indicating errors and warnings on the workspace.
  6. In the **Output** box, select one of:
    - **Result Pane** — displays ERC results in the **Results** tab of the **Spreadsheet View**. If you select **Clear Pane**, any previous ERC results will be cleared from the **Results** tab when a new ERC is run. Refer to "Result Pane" on page 5-35 for an example.
    - **File** — the results are saved in the filepath and name that you enter in the **File** field. Refer to "File" on page 5-35 for an example.
    - **List View** — the results display in a report format as shown in "List View" on page 5-36.

### 5.4.1.1 Clearing ERC Markers

- To clear ERC markers without running a new Electrical Rules Check:
  1. Select **Tools/Clear ERC Markers** to display the ERC Marker Deletion Scope dialog box.
  2. Select one of:
    - **Current Page** — to clear the ERC markers from the currently selected page.
    - **Whole Design** — to clear the ERC markers from all pages associated with the design.
  3. Click **OK** to delete the selected markers.

## 5.4.2 ERC Rules Tab

This section describes how to set up the electrical rules used when running an Electrical Rules Check. To run an ERC, see “5.4 Electrical Rules Checking” on page 5-34.

- To set up the electrical rules:



1. Select **Tools/Electrical Rules Check** to display the **Electrical Rules Check** dialog box.
2. Click on the **ERC Rules** tab.

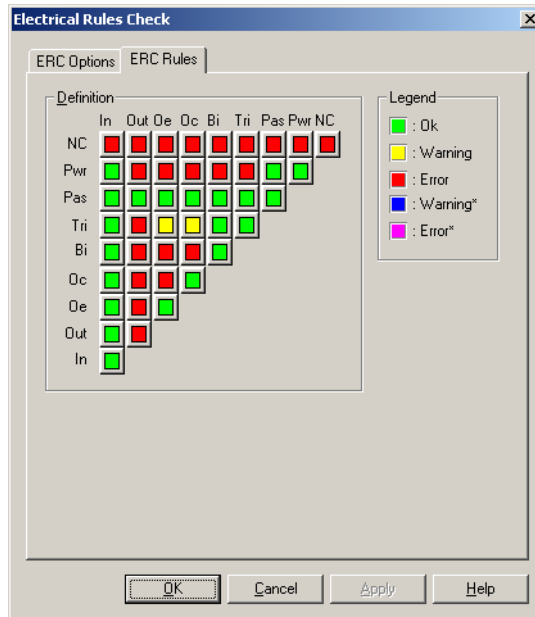

- Set the desired warning or error levels by clicking on the button that appears at the intersection of the desired pin types in the grid found in the **Definition** box. Click until the desired color, based on the **Legend** appears. For clarity, some examples are shown below.

ERC symbol. See chart below.

Example 1 - This button indicates "OK" for connection of Pas (passive) to In (input) pin.

Example 2 - This button indicates an error for connection of Oc (open collector) to Oe (open emitter) pin.

Warning and error levels. See "Level" on page 5-41 for explanation.

Component Pin Type	In	Out	Oe	Oc	Bi	Tri	Pas	Pwr	NC
NC	Red	Red	Red	Red	Red	Red	Red	Red	Red
Pwr	Green	Red	Red	Red	Red	Red	Green	Green	
Pas	Green	Green	Green	Green	Green	Green	Green		
Tri	Green	Red	Yellow	Yellow	Green	Green			
Bi	Green	Red	Red	Red	Green				
Oc	Green	Red	Red	Green					
Oe	Green	Red	Green						
Out	Green	Red							
In	Green								

**Note** The table below details the pin types available on the various components in Multisim.

Pin Type	Pin Type from Multisim Component Editor	ERC Symbol
INPUT	Input, 74LS Input, 74S Input, 74 STD Input, CMOS Input, Schmitt Trigger, ECL Input.	In
OUTPUT	Output, Active Driver, 74LS Active Driver, 74S Active Driver, 74STD Active Driver, CMOS Active Driver.	Out
OPEN_COLLECTOR	Open Collector, 74S Open Collector, 74STD Open Collector, CMOS Open Collector, 74LS Open Collector.	Oc
OPEN_EMITTER	ECL Output.	Oe
BI_DIRECTIONAL	Bi-directional, 74LS Bi-directional, 74S Bi-directional, 74STD Bi-directional, CMOS Bi-directional.	Bi
3-STATE	3-state, 74LS 3-state, 74S 3-state, 74STD 3-state, Bi-directional-3st, CMOS 3-State.	Tri

Pin Type	Pin Type from Multisim Component Editor	ERC Symbol
PASSIVE	Passive	Pas
POWER	Power, Vcc, Vdd, Vee, Vpp	Pwr
GND	Gnd, Vss	Pwr
NC	NC (no connection)	NC

The following explains the warning and error levels available.

Level	Description
Ok	Green button. No message is displayed after an Electrical Rules Check.
Warning	Yellow button. A warning message is displayed after an Electrical Rules Check.
Error	Red button. An error message is displayed after an Electrical Rules Check.
Warning*	Blue button. A warning message is displayed after an Electrical Rules Check, only if no other pin type is present.
Error*	Purple button. An error message is displayed after an Electrical Rules Check, only if no other pin type is present.

### 5.4.3 Component's Pins Tab

Before running an Electrical Rules Check (see “5.4 Electrical Rules Checking” on page 5-34), you can set which pins to exclude or include for specific components.

- To set up which pins in a component to include or exclude from an ERC:
  1. Double-click on the desired component to display its properties dialog box and click on the **Pins** tab.

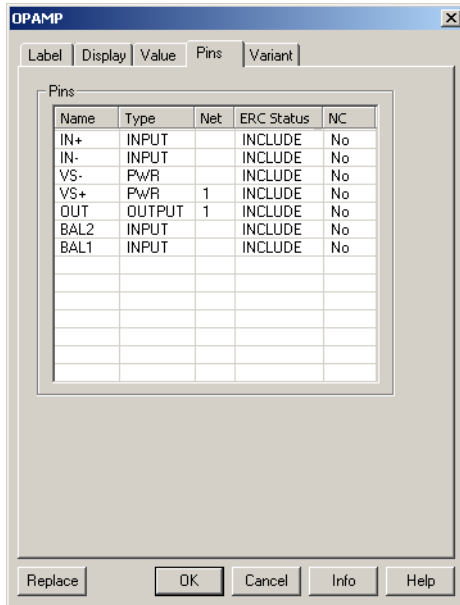

2. In the **ERC Status** column, select either Include or Exclude for each of the component's pins.
3. Click **OK** to close the dialog box.



# Chapter 6

## Working with Larger Designs



Some of the features described in this chapter may not be available in your edition of Multisim 9. Such features have an icon in the column next to their description. Refer to the release notes for a list of the features in your edition.

The following are described in this chapter.

<b>Subject</b>	<b>Page No.</b>
<b>Flat Multi-sheet Design</b>	6-2
Delete Multi-page Dialog Box	6-3
<b>Hierarchical Design</b>	6-3
Nested Circuits	6-4
Component Numbering in Nested Circuits	6-5
Net Numbering in Nested Circuits	6-6
Global Nets	6-6
Adding a Hierarchical Block	6-7
Adding a Subcircuit	6-9
Viewing Parent Sheet	6-11
<b>Renaming Component Instances</b>	6-11
Reference Designator Prefix Setup Dialog	6-13
<b>Buses</b>	6-16
Placing a Bus	6-18
Bus Properties	6-21
Merging Buses	6-24
Wiring to a Bus	6-25
Bus Vector Connect	6-27
<b>Variants</b>	6-34
Setting Up Variants	6-34
Placing Parts in Variants	6-37

Subject	Page No.
<b>Project Management and Version Control</b>	6-47
Setting up Projects	6-48
Working with Projects	6-49
Working with Files Contained in Projects	6-50
Version Control	6-51

## 6.1 Flat Multi-sheet Design

In many instances circuit designs are too large to fit all components on a single sheet or for logical reasons it's easier to think of a circuit design if it is divided. In this case, you can use Multisim's Flat Multi-sheet Design feature. This allows you to place off-page connectors between different sections of your circuit.

➤ To add another sheet to a circuit:

1. Select **Place/Multi-Page**. The **Page Name** dialog box displays.
2. Enter the desired name and click **OK**. A blank circuit appears with the name that you entered above.
3. Place components and wire the circuit as desired.
4. Select **Place/Connectors/Off Page Connector**. A “ghost” image of an off-page connector displays attached to your mouse pointer.
5. Drag the “ghost” image to the desired location and click to place the connector. Repeat for any other required off-page connectors.
6. Wire the off-page connectors into the circuit.
7. Save the file and return to the main circuit window.
8. Select **Place/Connectors/Off Page Connector**. A “ghost” image of an off-page connector displays attached to your mouse pointer.
9. Drag the “ghost” image to the desired location and click to place the connector. Repeat for any other required off-page connectors.
10. Wire the off-page connectors into the main circuit.

---

**Caution** To achieve a connection between a point in the main circuit and a point in another page, the name of the off-page connector in the main circuit must be the same as in the other page. For example, “OffPage1” in the main circuit, will be connected to “OffPage1” in the other (flat) page.

---

**Note** See also “6.4.1.2 Connecting Buses to HB/SCs” on page 6-19.

## 6.1.1 Delete Multi-page Dialog Box

- To delete a page from a multi-page circuit file.
  1. Select **Edit/Delete Multi-Page**.

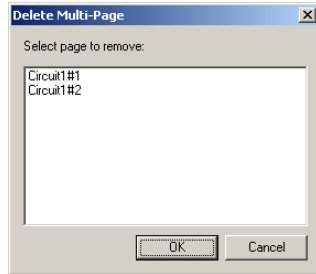

2. Highlight the page that you wish to delete and click **OK**.

## 6.2 Hierarchical Design



Hierarchical blocks and subcircuits are used to organize functionally related parts of a design into manageable pieces. Multisim's hierarchical functionality allows you to build a hierarchy of inter-connected circuits, increasing the reusability of your circuit designs and ensuring consistency across a group of designers. For example, you might build a library of commonly used circuits, stored in a central location. Those circuits could in turn be contained in other, more complex circuits, which could be used to create yet another level of circuit design. Since the interconnected circuits are linked together, and updated automatically, you can ensure that refinements made to one circuit are carried out in all related circuits as well. This lets you, for example, divide a complex project into smaller, interconnected circuits for completion by individual team members.

Hierarchical blocks and subcircuits are similar except that subcircuits are saved with the original circuit and hierarchical blocks are individual circuit files that are referenced from a main file. The connection method is the same for both using the **HB/SC Connector**.

Sub-circuits are easier to manage, as they cannot accidentally become separated from the circuit that references them. Hierarchical blocks are useful when re-using nested circuits across multiple designs, or for dividing the work when multiple designers are working on the same design.

When using hierarchical blocks, the “block” remains a separate schematic file which can be edited. The connection between a block and the circuit in which it is placed is an active link — if you place the contents of circuit A as a block of circuit B, you can open circuit A separately, make any changes necessary, and those changes are reflected in circuit B the next time you open it and in any other circuits that use circuit A.

## 6.2.1 Nested Circuits

When a circuit file is opened or created in Multisim, by definition it is the top-level circuit of the current design. All circuits may reference other, embedded (subcircuit) or linked-to (hierarchical block) nested circuits, which act as building blocks to control circuit complexity. In addition, any circuit (nested or otherwise), may comprise multiple pages for ease of understanding and printing. The **Hierarchy** tab in the **Design Toolbox** displays a graphical view of the open designs.

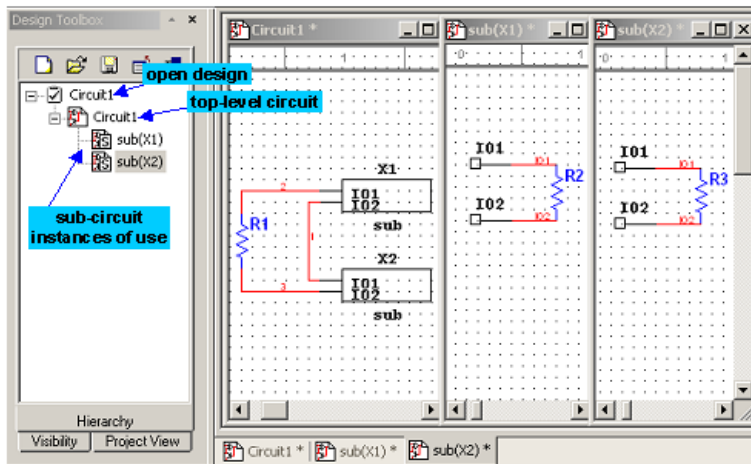

If the same nested circuit is used more than once in a design, it will appear more than once in the hierarchy view, and will have more than one tab in the main workspace. Each appearance is an *instance of use* of that nested circuit. Use instances are identified by a path formed by the names of the references used to reach them. In the simple example above, there are two ways to reach "sub": one via the reference X1 in Circuit1 and one via the reference X2.

With one notable exception (RefDes assignment), edits made to one instance of use are reflected in all others (because it is actually the same circuit that is being modified). Different views are maintained of each use instance in order that simulation may distinguish them. Thus, if a probe (see “10.15 Measurement Probe” on page 10-40) was dragged over the net IO1 in the X1 instance of sub, it would show a different voltage than if it were dragged over the same net in the X2 instance.

## 6.2.2 Component Numbering in Nested Circuits

Every part in a design has a unique reference designator (RefDes), such as R5, U2, and so on. A RefDes is assigned by default when a component is placed by taking a single letter typical of the type of part being placed (R for resistors, C for capacitors, and so on) followed by the next highest available number. You may edit these to be anything you like, so long as they are unique across a design. In the case of multi-section parts, the RefDes will also include the section identifier.

The assignment of RefDes to part is stored with the top-level circuit, and not with any of the nested circuits. This is because the same nested circuit may appear more than once in a design. Were the RefDes to be associated with a nested circuit, duplicate RefDes would appear in this situation. To combat this, it is the top-level circuit that associates a RefDes with each part's instance of use. Thus, a hierarchical block opened via top-level circuit 1 will have all the same components as are in the same hierarchical block opened via top-level circuit 2, however they will have different RefDes.

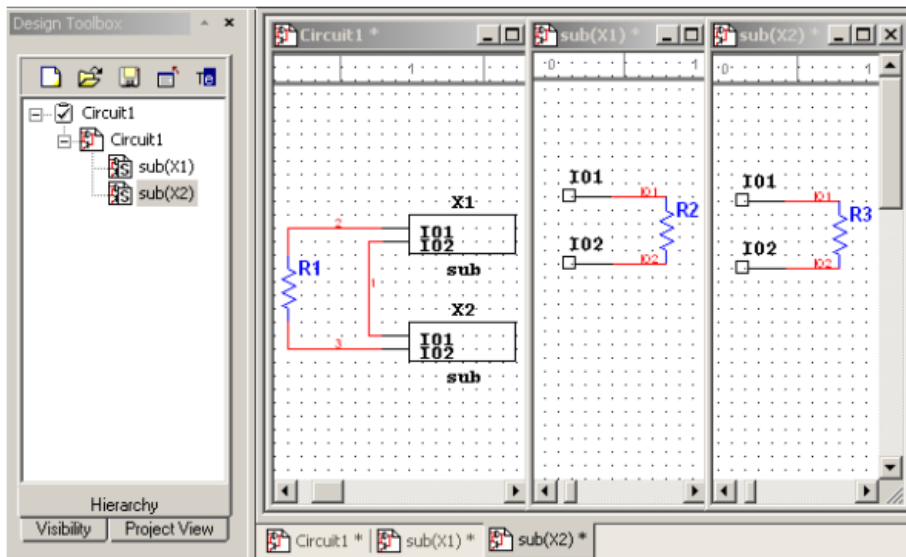

In the above example, we see Circuit1 referencing the same sub-circuit, **sub**, twice. The components, their placement, the wiring, and the net names in the sub-circuit are identical in the two instances (because they are, after all, the same sub-circuit: **sub**). However, the RefDes of their components are different, as the association of RefDes to component instance is stored with and managed by the containing design, Circuit1.

## 6.2.3 Net Numbering in Nested Circuits

Net names are unique across all the pages of a multi-page circuit. However, net names may be repeated in nested circuits. This does not cause any ambiguity, however, as the "real" names of nets in nested circuits are formed by pre-pending a dot-separated path of references to reach the circuit instance. In the diagram below, 'X1.IO1' is the full name of net number IO1 in the sub-circuit referenced by the RefDes 'X1' from the top-level circuit.

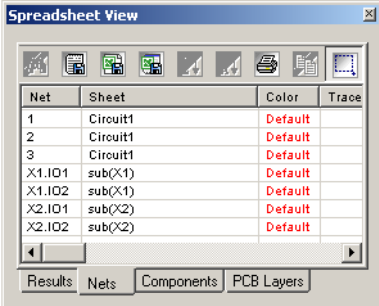

The screenshot shows a window titled "Spreadsheet View" with a toolbar and a table. The table has four columns: Net, Sheet, Color, and Trace. The data is as follows:

Net	Sheet	Color	Trace
1	Circuit1	Default	
2	Circuit1	Default	
3	Circuit1	Default	
X1.IO1	sub(X1)	Default	
X1.IO2	sub(X1)	Default	
X2.IO1	sub(X2)	Default	
X2.IO2	sub(X2)	Default	

At the bottom of the window, there are tabs for "Results", "Nets", "Components", and "PCB Layers".

## 6.2.4 Global Nets

Certain pre-defined named nets are considered global across an entire design. That is to say, anytime a net at any level in the hierarchy or on any page is re-named to one of these reserved nets, it joins this net. These reserved nets are 0, GND, VCC, VDD, VEE, and VSS. Net 0 corresponds to analog ground, and is the reference for all voltages during simulation. GND is a digital ground (as it is common for the purposes of PCB layout to wish to isolate these two ground nets).

Components like VCC, VDD, etc. that use the "T" symbol; or the GND component that uses the triangle symbol; can be renamed as desired. When a wire is attached to such a component, the netname is automatically changed to the name of the component. For example, in the diagram below, VCC was placed and then renamed to "power" by double-clicking on the

component and changing the RefDes to "power". The netname automatically changed to "power" to match the new component RefDes.



All instances of VCC are shown here.

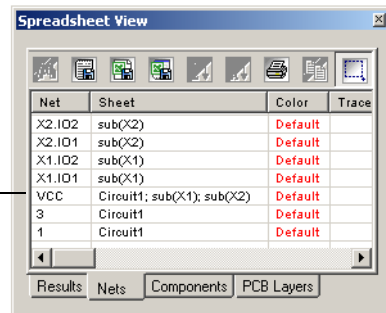

Nets created this way become accessible across pages in a multi-page circuit, without the use of Off-Page Connectors. If the symbol is placed into a nested circuit (SC or HB), the attached net is renamed to be a top-level net, and joins any other nets at the top-level with the same name. For example, having a net named "power" in a sub-circuit referenced by X1 from the top-level circuit would normally re-write the name of the net to "X1.power". This makes this net unique to any other net named "power" at the top-level or in any other nested circuit in the design (even other use instances of the same sub-circuit). However, placing a "T" component re-named to be "power" and then attaching a wire to it would result in the net being simply called "power". This creates a virtual wiring situation between all such nets named "power". Hence, this is a mechanism by which nets may be declared to be of the top-most net namespace, even when buried deeply into nested circuits.

## 6.2.5 Adding a Hierarchical Block

- To place a new hierarchical block:
  1. Select **Place/New Hierarchical Block**.

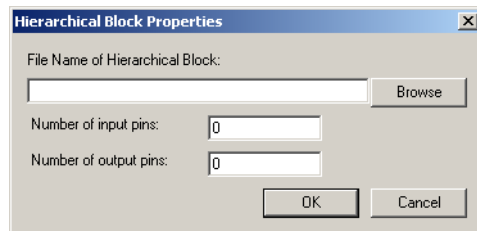

2. Enter a filename.
- Or*

3. Click on **Browse**, navigate to the folder where you would like to save the hierarchical block and click **Save**. You are returned to the **Hierarchical Block Properties** dialog box.
4. Enter the number of pins desired and click **OK**. A “ghost” image of the new hierarchical block appears. Click where you want the hierarchical block to appear.
5. Double-click on the new hierarchical block and select **Edit HB/SC** from the **Hierarchical Block/Subcircuit** dialog box that displays. A circuit window that contains only the entered pins displays.
6. Place and wire components as desired in the new hierarchical block.
7. Wire the hierarchical block into the circuit as in the example below.

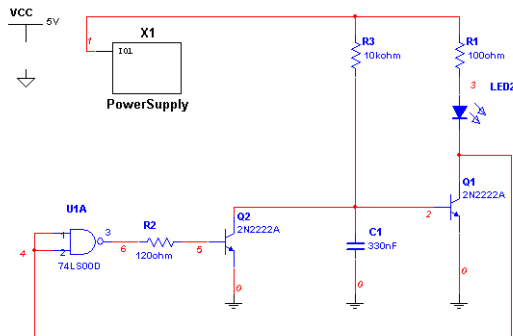

8. Save the circuit.

**Note** If you move or re-name a hierarchical block relative to the main circuit, Multisim will not be able to find it. A dialog box displays asking you to provide the new location for the hierarchical block.

### 6.2.5.1 Placing a HB from an Existing File

- To place a hierarchical block from an existing file:
  1. Select **Place/Hierarchical Block from File**, navigate to the desired file and click **Open**. The circuit is placed on the workspace.
  2. You may need to add HB/SC connectors to the HB if they are not already present.
 

To do this, double-click on the placed HB’s symbol and select **Edit HB/SC**.  
 Select **Place/Connectors/HB/SC Connector**, and place and wire the connector as desired.

When you return to the main circuit, the symbol for the HB will include pins for the number of connectors that you added.



**Note** If you have already placed instances of the hierarchical block, the following dialog displays:

Select which hierarchical block you wish to use to assign grouping information in the new hierarchical block and click OK.

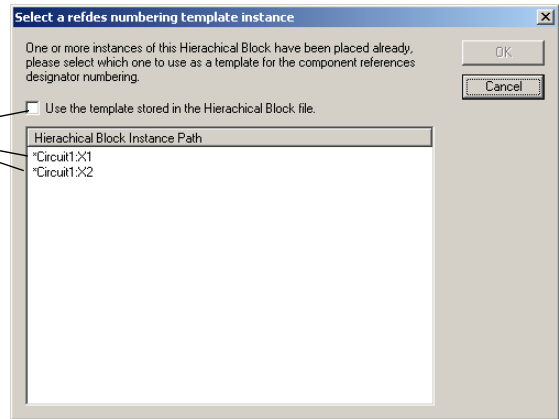

### 6.2.5.2 Replacing Components with an HB

- To replace a section of a schematic with a hierarchical block (HB):
  1. In the workspace, select the desired components and nets.
  2. Select **Place/Replace by Hierarchical Block**. The **Hierarchical Block Properties** dialog box appears. Enter the desired filename and click **OK**.
  3. The selection is replaced by a HB symbol that is correctly wired into the circuit.

## 6.2.6 Adding a Subcircuit

- To place a new subcircuit:
  1. Select **Place/New Subcircuit**. The **Subcircuit Name** dialog box appears.

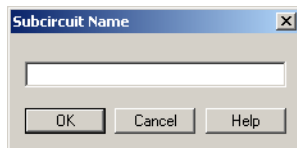

2. Enter the name you wish to use for the subcircuit, for example, “PowerSupply” and click **OK**. Your cursor changes to a “ghost” image of the subcircuit indicating that the subcircuit is ready to be placed.
3. Click on the location in the circuit where you want the subcircuit placed (you can move it later, if necessary).

The subcircuit appears in the desired location on the circuit window as an icon with the subcircuit name inside it.

4. Double-click on the new subcircuit and select **Edit HB/SC** from the **Hierarchical Block/Subcircuit** dialog box that displays. An empty circuit window appears.
5. Place and wire components as desired in the new hierarchical block.
6. Select **Place/Connectors/HB/SC Connector**, and place and wire the connector as desired. Repeat for any other required HB/SC Connectors.

When you return to the main circuit, the symbol for the subcircuit will include pins for the number of connectors that you added.

7. Wire the subcircuit into the circuit as in the example below.

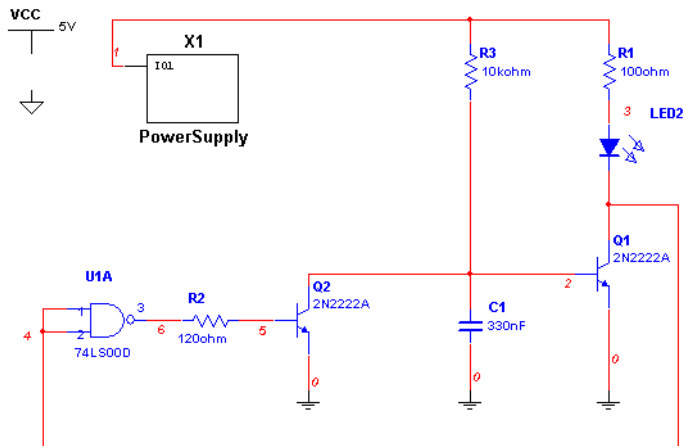

- To place another instance of the same subcircuit:

1. Select the desired subcircuit in the workspace and select **Edit/Copy**.
2. Select **Edit/Paste** to place a copy of the subcircuit on the workspace.

**Note** The copy should be pasted in the same file as the original subcircuit.

### 6.2.6.1 Replacing Components with a SC

- To replace a section of a schematic with a SC:
  1. In the workspace, select the desired components and nets.
  2. Select **Place/Replace by Subcircuit**. The **Subcircuit Name** dialog box appears.
  3. Enter the name you wish to use for the subcircuit and click **OK**. The selection is replaced by a SC symbol that is correctly wired into the circuit.

## 6.2.7 Viewing Parent Sheet

When you are viewing a subcircuit or hierarchical block you can quickly move to its parent sheet by using the procedure that follows. This is particularly useful when you have many circuits open at once.



- To view an active subcircuit or hierarchical block's parent, select **View/Parent Sheet**.

**Note** This command will move you to the next circuit upwards in the hierarchy. If you have multiple nested circuits and are viewing, for example, a subcircuit within a subcircuit, you will not move to the top of the hierarchy.

## 6.3 Renaming Component Instances

The **Rename Component Reference Designators** dialog box is used to rename/renumber components to, for example, eliminate gaps in numbering. This should be done just before the circuit is exported to PCB layout.

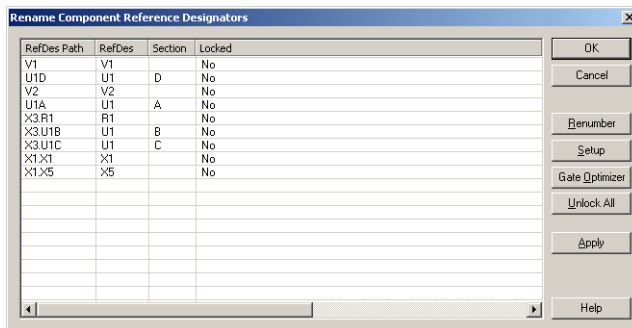

The columns in the dialog box contain the following information:

- **RefDes Path** — the path for the component. If the component is located on the main sheet (that is, *not* in a subcircuit, hierarchical block, or multi-page, the path will only contain the

component's reference designator (RefDes), as in the example "V1". If the component is not on the main sheet, the sheet on which it is located also shows, as in the example "X3.R1". This indicates that R1 is found on the subcircuit referenced by X3.

- **RefDes** — The reference designator of the component as it appears on the workspace.
- **Section** — The section of a multi-section component.
- **Locked** — "Yes" indicates that the component will not be changed by either a **Renumber** or an **Optimize** command.

➤ To renumber the components in a circuit:

1. Select **Tools/Rename/Renumber Components**.

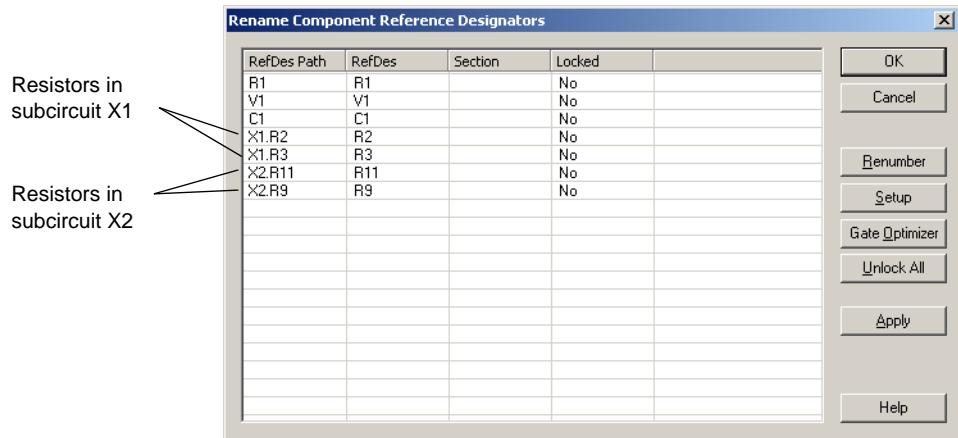

2. Click **Renumber**.

RefDes Path	RefDes
R1	R1
V1	V1
C1	C1
X1.R2	R2
X1.R3	R3
X2.R11	R4
X2.R9	R5

RefDes's in X2 have change to follow sequence (R1 through R5)

3. Click **OK** to close the dialog box and accept the changes.

➤ To optimize the circuit so that multi-section components are used as efficiently as possible:

1. Select **Tools/Rename/Renumber Components**.
2. Click **Optimize Gates**.

## 6.3.1 Reference Designator Prefix Setup Dialog

This section uses the example of two instances of the same subcircuit. Please note that the **Reference Designator Prefix Setup** dialog box can be used to assign a unique numbering system for each subcircuit, hierarchical block or multi-page. This is very helpful when trying to identify components in a design.

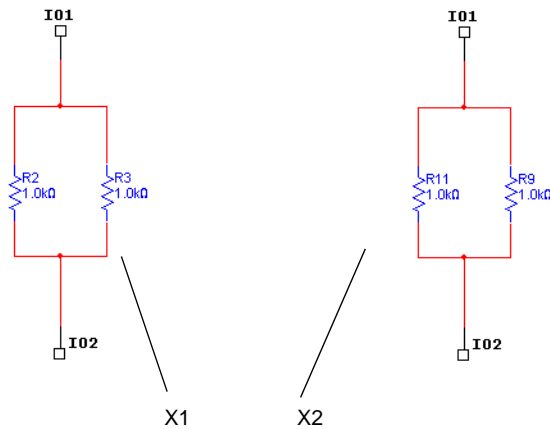
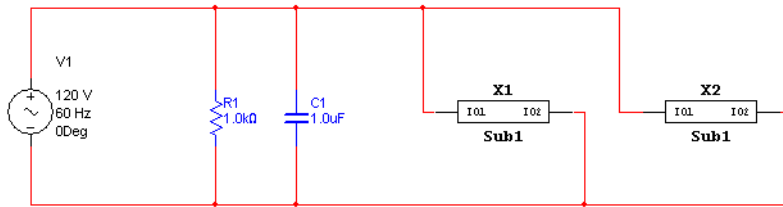

Note: X1 and X2 are instances of the same subcircuit.

➤ To set up renaming parameters:

1. Click **Setup** from the **Rename Component Reference Designators** dialog box. The following dialog box appears:

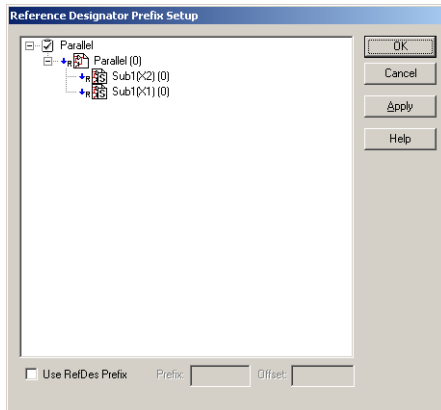

2. Select the item for which you wish to set up numbering parameters and enable **Use RefDes Prefix**.

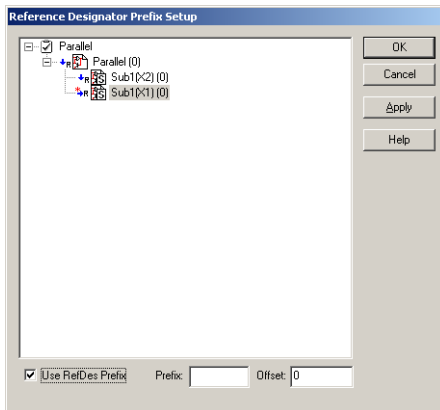

3. If desired, enter a prefix for the components in the selection in the **Prefix** field, for example "Beta".

- Enter the starting number for each RefDes in the selection in the **Offset** field, for example “100”.

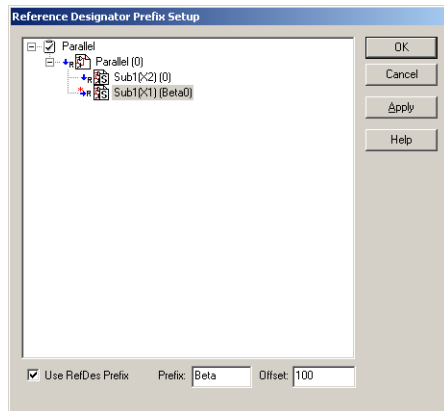

- Click **OK** to return to the **Rename Component Reference Designators** dialog box.
- Click **Renumber**. The RefDes's are renumbered to reflect the changes to the setup that you made in the **Reference Designator Prefix Setup** dialog box.

Prefix of "Beta" has been added to each component in the instance of the subcircuit.

Component numbering sequence for components in the instance of the subcircuit begins at "100".

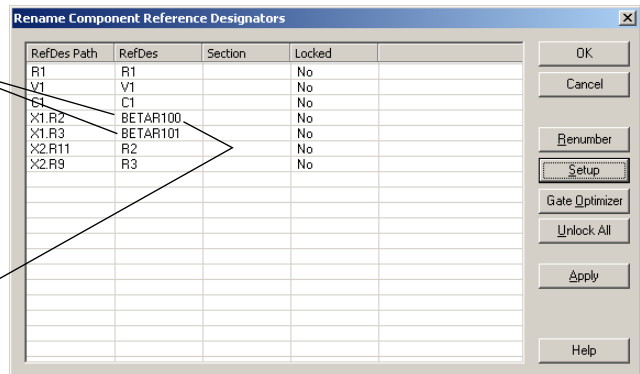

7. Click **OK** to accept the changes.

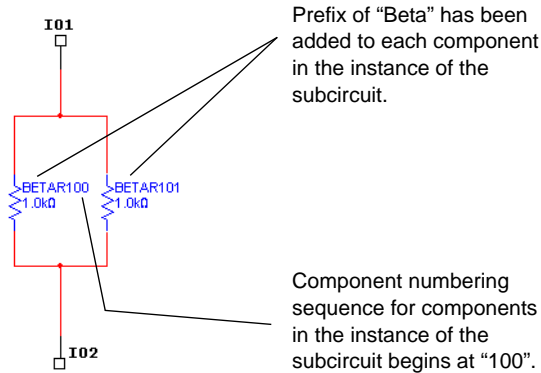

## 6.4 Buses

In order to simplify wiring, buses may be used to carry multiple nets. Buses may be used within a page, across pages, and down into nested circuits (subcircuits and hierarchical blocks).

Buses operate in two modes. In *net mode*, a bus is simply a collection of nets. Each time a wire is connected to a bus via a bus entry, you are given the choice of connecting that new wire to an existing net already in the bus, or of adding that net to the bus.

In *busline mode*, you may pre-define the number and names of buslines that are contained in that bus. When connecting a wire to the bus via a bus entry, you are prompted to specify which of the existing buslines the new wire should attach to. All wires attached to the same busline are merged into the same net.

**Note** The bus wiring mode is set in the **Wiring** tab of the **Sheet Properties** dialog box. See "3.4.2.3 Sheet Properties - Wiring Tab" on page 3-29.



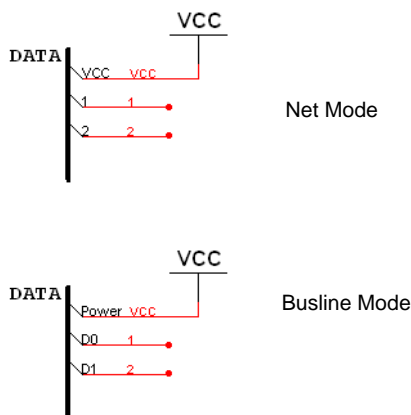

Net mode is a more traditional way of using buses in schematic capture programs. Busline mode allows for a more modern, declaration-before-use, approach to designing buses that minimizes entry errors. Although you can switch between the two modes, you are encouraged to use either one style or the other for any given circuit (switching from busline mode to net mode loses information).

Buses exist in multiple bus segments. All bus segments with the same name are parts of the same bus. They need not all be connected physically. To connect a bus to other pages of the same circuit, a bus offpage connector is used. These work analogously to regular offpage connectors in that they allow a bus to be continued onto a second or third page.

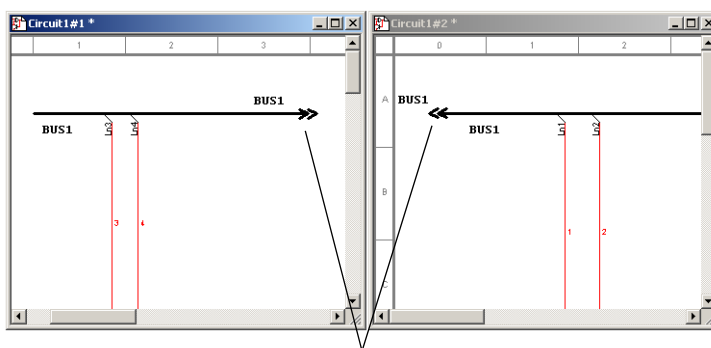

Bus Offpage Connectors

A nested circuit can use a Bus HB/SC Connector to specify that one of the pins of the hierarchical block or subcircuit should be a bus pin. When using the nested circuit, attaching a bus to such a bus pin brings up a dialog box asking you to map the buslines (or nets) of the bus on the parent circuit to those in the nested circuit. This mapping is necessary as each instance

of a nested circuit may in general be connected to a different bus. If the bus in the parent circuit is empty, no dialog will be presented and the bus will be wired in the natural manner.

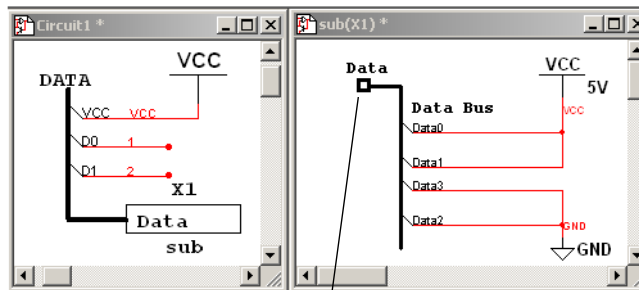

Bus HB/SC Connector

To facilitate usage of buses, a powerful *bus vector connect* facility is provided that allows for multiple pins of a chip to be connected to a bus in a single operation. This dialog allows you to select pins from multi-pin components to connect to the buslines.

## 6.4.1 Placing a Bus

➤ To place a bus in your circuit:



1. Select **Place/Bus**.
2. Click on the first point for the bus.
3. Click on the next point for the bus.
4. Continue to click on points until the bus is complete. Buses can be placed horizontally, vertically, and at 45 degrees.
5. Double-click to mark the ending point of the bus.

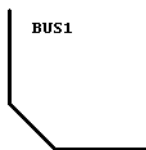

### 6.4.1.1 Placing a bus across Multi-pages

- To place the same bus across multi-pages:
  1. Select **Place/Connectors/Bus-Offpage Connector** to place a **Bus-Offpage Connector** on the workspace.
  2. Wire the connector to the desired bus.
  3. Place a bus on the multi-page, and wire another **Bus-Offpage Connector** to the bus.
  4. Double-click on the bus and change its name to match the busname of the bus on the main page.

### 6.4.1.2 Connecting Buses to HB/SCs

- To connect a bus to a bus on a hierarchical block (HB) or a subcircuit (SC):
  1. Place a bus on the workspace as described in “6.4.1 Placing a Bus” on page 6-18.
  2. Attach wires to the bus as described in “6.4.4 Wiring to a Bus” on page 6-25.
  3. Place a hierarchical block or subcircuit on your workspace.
  4. Place a bus in the HB/SC and attach wires to it as desired.

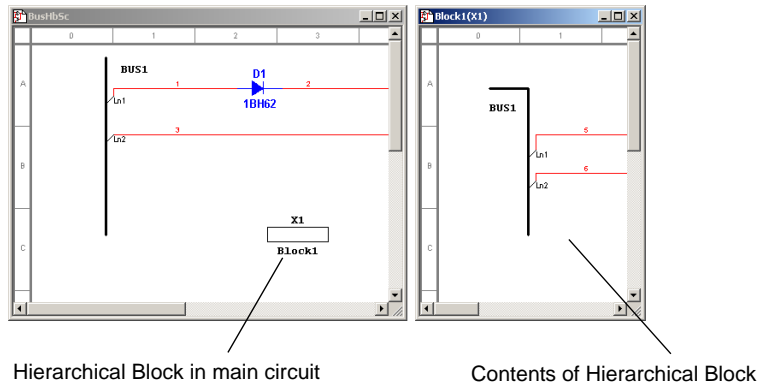

**Note** This example uses a hierarchical block.

5. Select **Place/Connectors/Bus HB/SC Connector** and place the connector in the HB/SC on the end of the bus. The symbol for the HB/SC in the main circuit will change to reflect the addition of the **Bus HB/SC Connector**. (See below).

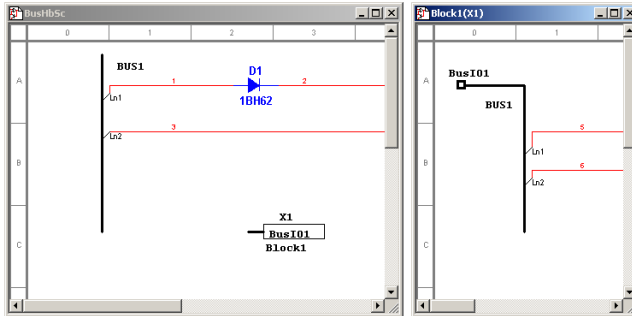

6. In the main circuit, attach the bus to the BusIO pin on the HB/SC by hovering the cursor over one end of the bus and clicking when the cursor changes to a crosshair. Move the cursor to the BusIO pin on the HB/SC symbol and click to place. The **Bus HB/SC Mapping Properties** dialog box appears.

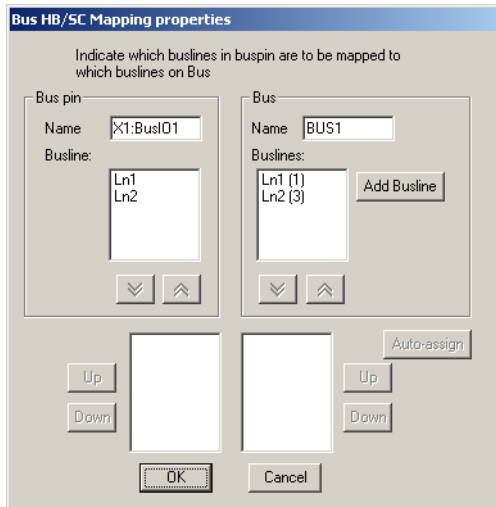

7. In the **Bus Pin** box, select the buslines from the Bus IO pin you wish to map and click on the activated down-arrow button.

8. In the **Bus** box on the right, select the buslines on the main page to which you wish to map the buslines that you selected above and click the down-arrow.

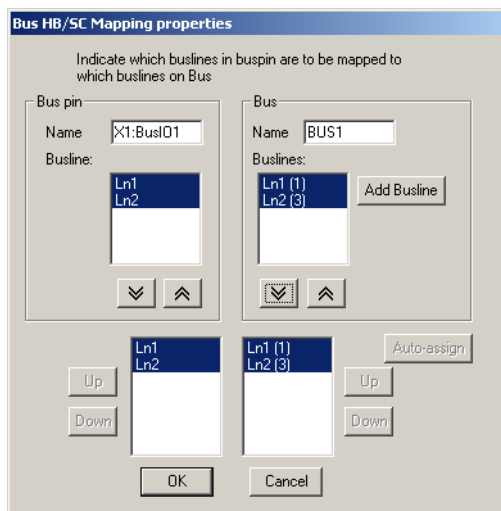

9. Click **OK**. The connection from the bus in the main circuit is made to the Bus IO pin as mapped above.

**Note** If you add more nets to the bus, you must double-click on the **Bus IO** pin in the sub-circuit or hierarchical block symbol and map the new nets via the **Bus HB/SC Mapping Properties** dialog box.

## 6.4.2 Bus Properties

You can add, delete and rename buslines from the **Bus Properties** dialog box.

### 6.4.2.1 Adding buslines to a Bus

When you are in the Busline mode (see “6.4 Buses” on page 6-16) you can pre-enter buslines for use when wiring to a bus.

➤ To add buslines to a bus:

1. Double-click on a placed bus to display the **Bus Properties** dialog box.

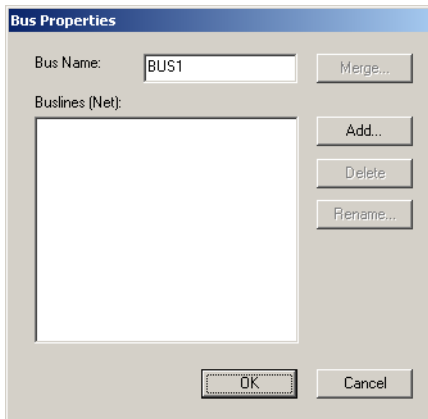

2. Click **Add** to display the **Add Buslines** dialog box.

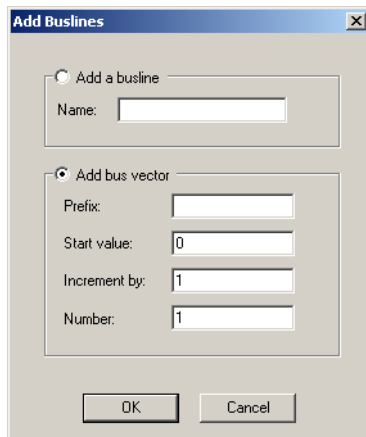

3. If you wish to add a single busline to the selected bus, enable **Add a Busline** and type a name into the **Name** field.

If you wish to add a number of buslines, enable **Add Bus Vector** and enter information in the fields as described:

- **Prefix** — the prefix for the entered buslines, for example “Out”.
- **Start Value** — the number from which the buslines will start numbering, for example, “0”.
- **Increment by** — the size of the the step between each number, for example, “1”.
- **Number** — the total number of buslines to add, for example, “4”.

- Click **OK**. The **Add Buslines** dialog box disappears, and the **Bus Properties** dialog box appears with the added buslines appearing in the **Buslines (Net)** field.

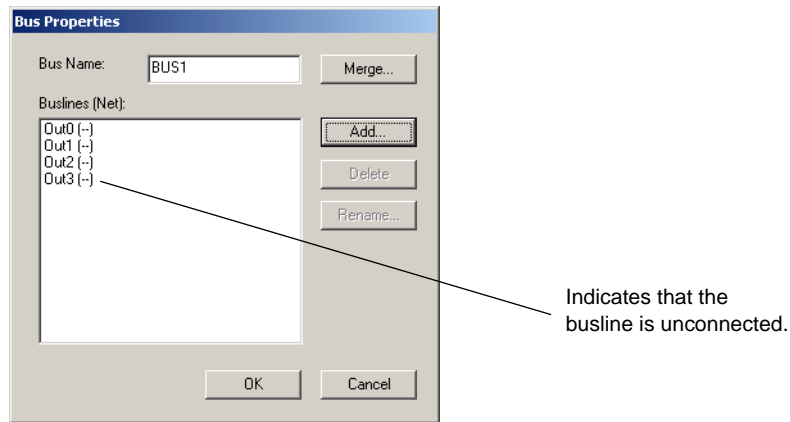

### 6.4.2.2 Deleting Buslines from a Bus

- To delete buslines from a bus:
  - Double-click on a placed bus to display the **Bus Properties** dialog box.
  - Select the desired bus(es) in the **Buslines (Net)** field and click **Delete**.

### 6.4.2.3 Renaming Buslines in a Bus

- To rename buslines in a bus:
  - Double-click on a placed bus to display the **Bus Properties** dialog box.
  - Select the desired bus(es) in the **Buslines (Net)** field and click **Rename**. The **Rename Busline** dialog box appears.

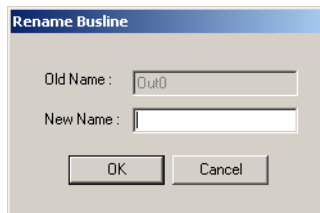

- Enter the desired name in the **New Name** field and click **OK**.

## 6.4.3 Merging Buses

- To merge two buses together so that they have the same busname:
  1. Highlight the two buses and select **Place/Merge Bus** to display the **Bus Merge** dialog box.

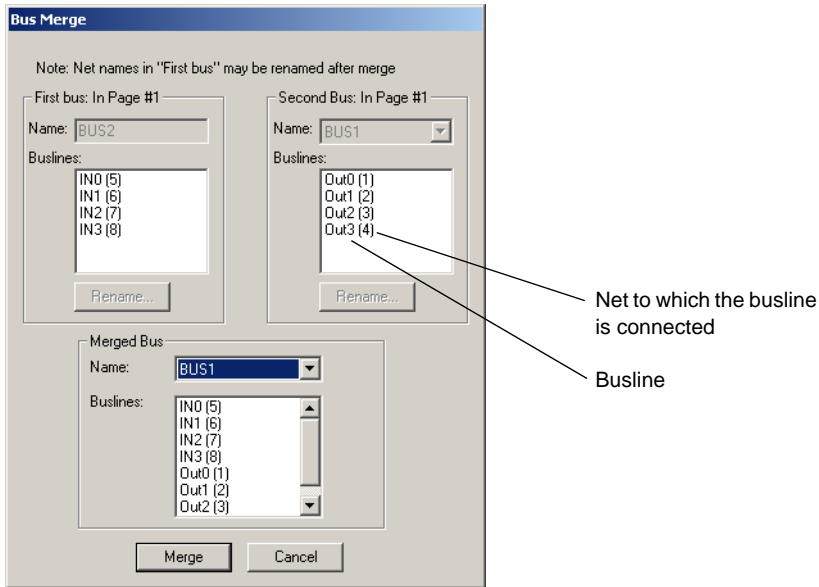

**Tip** If you want to rename busline(s) before merging the buses, select the desired busline(s) and click **Rename**. Buslines with the same name in each of the merged buses will be electrically connected after the merge.

2. In the **Merged Bus** area, select the bus to use for the merged bus from the **Name** drop-down.
3. Click **Merge**. Note that the two buses on the workspace now share the selected name, as in the following example.

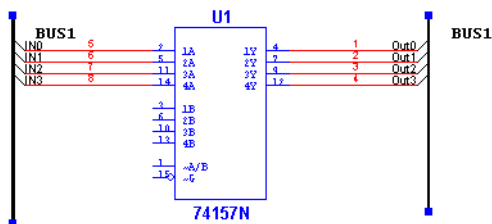



**Note** You can also access the **Bus Merge** dialog box by double-clicking on a bus, and clicking the **Merge** button in the **Bus Properties** dialog box. In this case, you must select the second bus from its **Name** drop-down list before clicking **Merge**. As well, you can merge buses by wiring them together or renaming one bus with the name of another existing bus.

## 6.4.4 Wiring to a Bus

### In Busline bus wiring mode

1. Wire the bus into your circuit by drawing a wire to any location on the bus. The **Bus Entry Connection** dialog box appears:

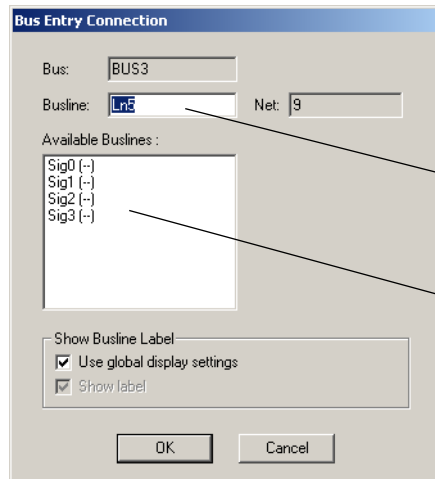

Use the default busline name, or type a new name.

Or

Select one of the available buslines.

2. Select the desired busline and click **OK**.

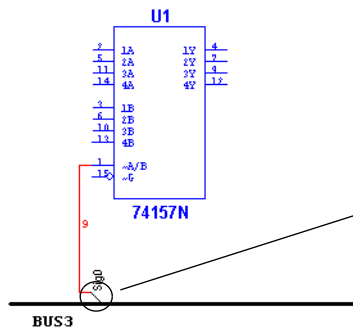

The 45 degree connection can be made to point in either direction by adjusting the mouse position when connecting the wire to the bus.

**Note** After wiring, you can re-name the net, by double-clicking on it and editing the name in the **Net** dialog box that appears.

**Note** You can select a bus entry to move it with the Arrow keys, or rotate it with SHIFT-R.

**Note** You can double-click on a bus entry to edit its properties via the **Bus Entry Connection** dialog box.

## In Net Bus Wiring Mode

1. Wire the bus into your circuit by drawing a wire to any location on the bus. The **Bus Entry Connection** dialog box appears:

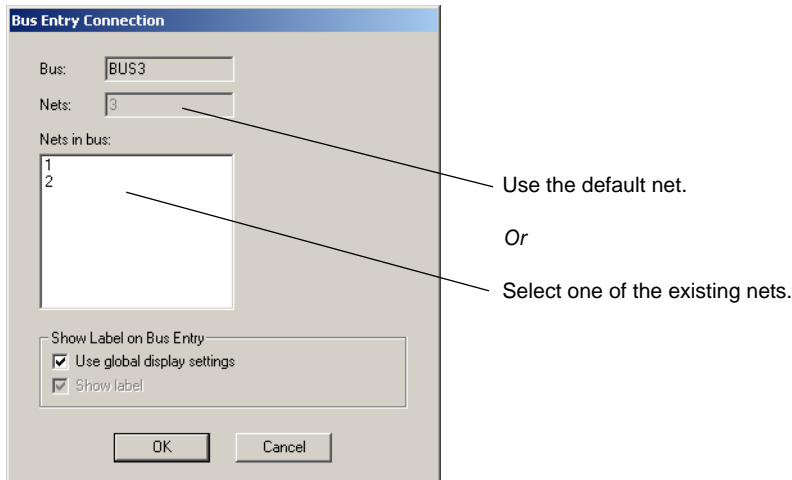

2. Select the desired net and click **OK**.

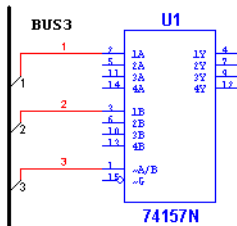

**Note** After wiring, you can re-name the net as usual, by double-clicking on it and editing the name in the **Net** dialog box that appears.

**Note** You can select a bus entry to move it with the Arrow keys, or rotate it with SHIFT-R.

**Note** You can double-click on a bus entry to edit its properties via the **Bus Entry Connection** dialog box.

## Bus Resizing

- To resize a bus:
  1. Click on the bus and drag one of the handles that appear on the bus.
- To add to the bus:
  1. Place the cursor over the bus, and when it turns to a crosshair, click the mouse.
  2. Move the cursor to the desired location and double-click to complete the bus.

## 6.4.5 Bus Vector Connect

Along with the method described in “6.4.4 Wiring to a Bus” on page 6-25, you can also use the **Bus Vector Connect** command. This is the preferred method for placing numerous connections from a multi-pinned device, such as an IC, to a bus.

The following example details the connection of an IC to a bus. However, the **Bus Vector Connect** functionality can be used to connect any multi-pin device to a bus.

### In Busline bus wiring mode

- To connect a device to a bus in Busline bus wiring mode:
  1. Place the component that you wish to connect to the bus on the workspace.
  2. Place a bus on the workspace as described in “6.4.1 Placing a Bus” on page 6-18.

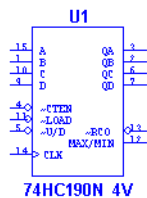

BUS1

For best results, position the bus so that it is at right-angles to the pins to be connected. Also, the bus should be long enough to comfortably accommodate the number of connections.

3. Click once on the component to select it and select **Place/Bus Vector Connect** to display the **Bus Vector Connect** dialog box.

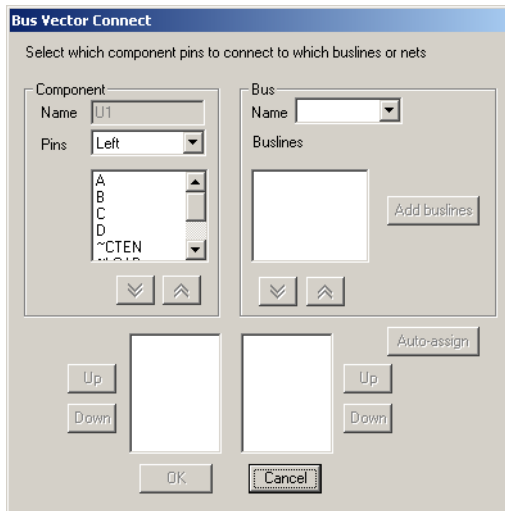

4. In the **Component** box, select the side of the component from which terminals should be connected from the **Pins** drop-down list. The list below the **Pins** field is populated based on your selection.
5. Highlight the pins that you wish to attach to the bus, as in the example below.

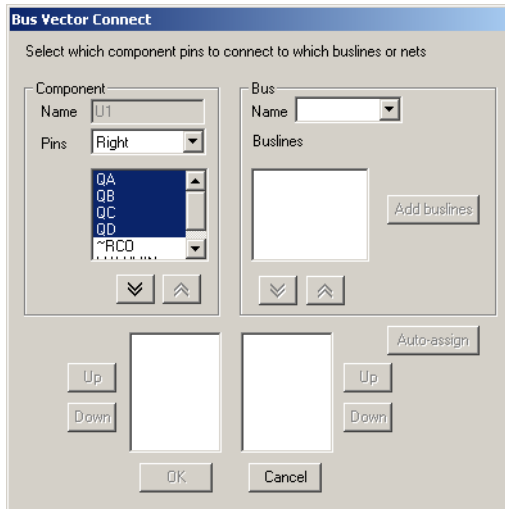

- Click on the activated down-arrow button to move the selected pins to the bottom left field.

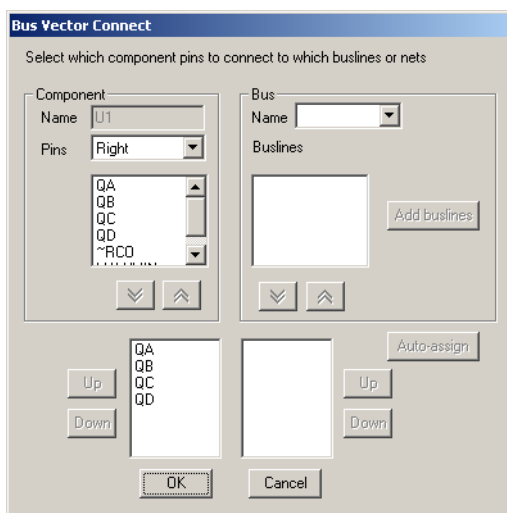

**Note** If you move an incorrect item, highlight it and click on the up-arrow button to return it to the **Pins** list.

- In the **Bus** box, select the bus you wish to connect to from the **Name** drop-down list.

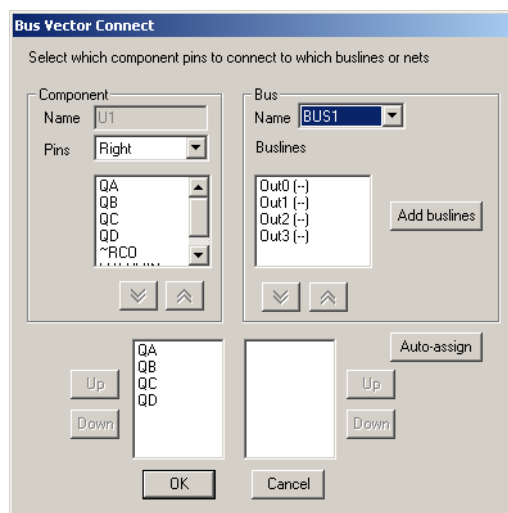

- In the **Buslines** field, select the buslines you wish to use and click on the enabled down-arrow button to move the selection to the lower-right field.

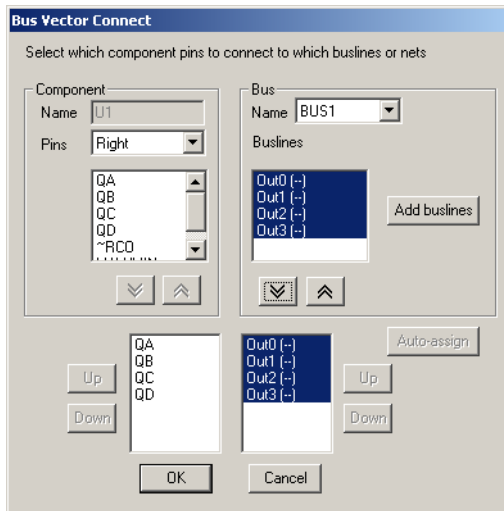

(If the **Buslines** field is empty, you can click on the **Auto-assign** button to automatically create and assign busline names that correspond to the pin names).

- Click **OK**. The connections to the bus are made as in the following example.

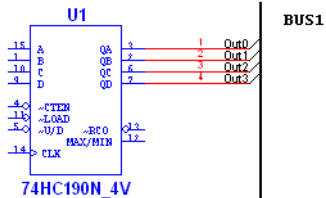

## In Net bus wiring mode

- To connect a device to a bus in Net bus wiring mode:
  1. Place the component that you wish to connect to the bus on the workspace.
  2. Place a bus on the workspace as described in “6.4.1 Placing a Bus” on page 6-18.

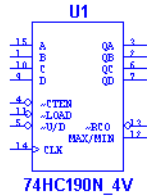

BUS1

For best results, position the bus so that it is at right-angles to the pins to be connected. Also, the bus should be long enough to comfortably accommodate the number of connections.

3. Click once on the component to select it and select **Place/Bus Vector Connect** to display the **Bus Vector Connect** dialog box.

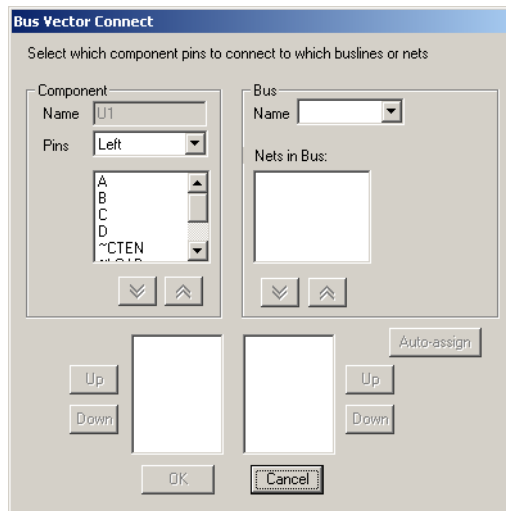

4. In the **Component** box, select the side of the component from which terminals should be connected from the **Pins** drop-down list. The list below the **Pins** field is populated based on your selection.

5. Highlight the pins that you wish to attach to the bus, as in the example below.

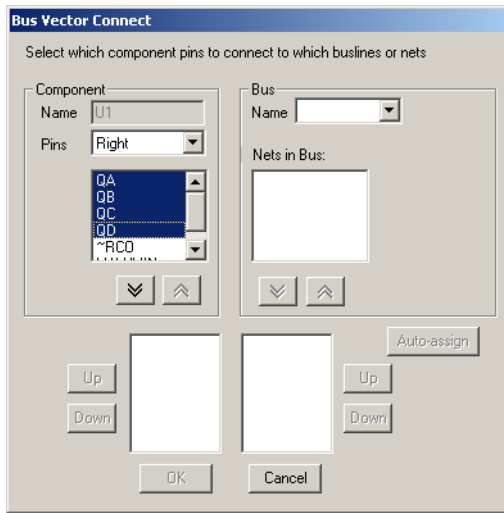

6. Click on the activated down-arrow button to move the selected pins to the bottom left field.

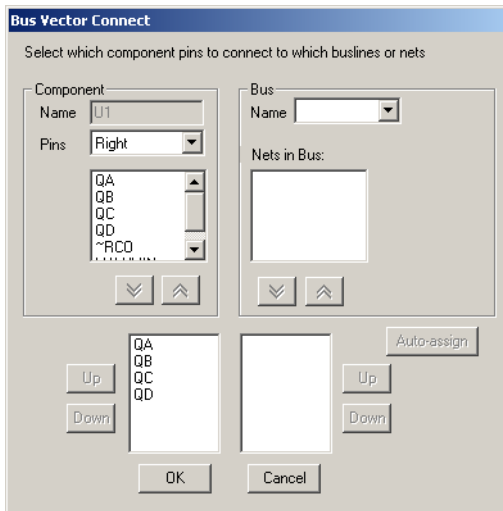

**Note** If you move an incorrect item, highlight it and click on the up-arrow button to return it to the **Pins** list.



7. In the **Bus** box, select the bus you wish to connect to from the **Name** drop-down list.

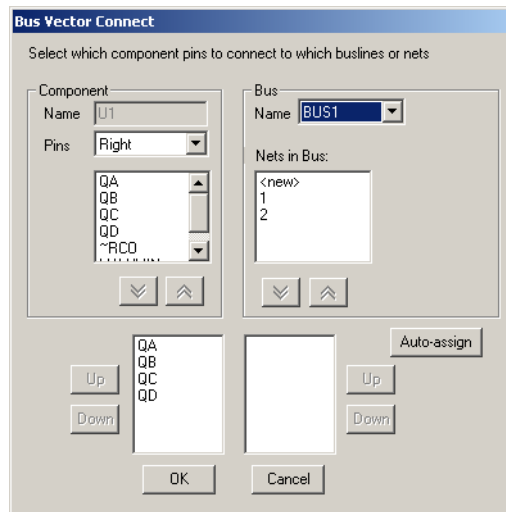

8. In the **Nets in Bus** field select:

- existing nets — for example, “1” and/or “2” in the above, and click the down-arrow button to move them to the bottom-right field.
- <new> — to map new nets to the selected component pins. Each time you click the down-arrow button when <new> is highlighted, an instance of <new> appears in the bottom-right field.

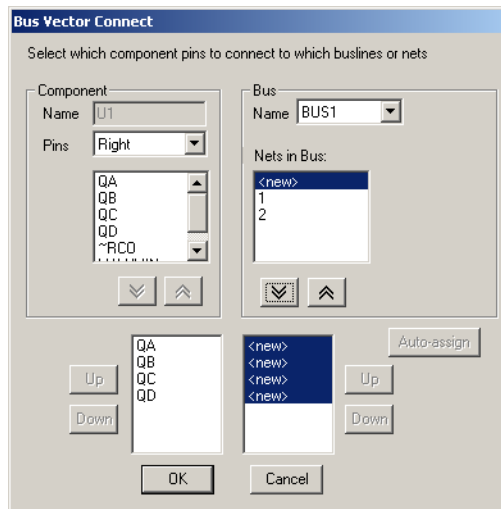

**Note** You can also click **Auto-assign** to automatically assign new nets to the mapped pins.

9. Click **OK**. The connections to the bus are made as in the following example.

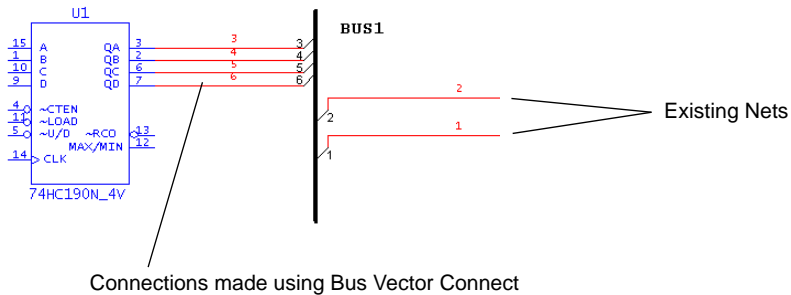

## 6.5 Variants



A variant is a specific version of a circuit. As PCBs are manufactured for distribution on a global scale, some designs may require modifications depending on their target markets. For example, power supply requirements for the European market differ from those of North America. The variations in the power supply requirements may call for the use of different components in a design. The designer would want to produce a single PCB which would meet requirements for both the North American and the European versions. The board itself must contain the traces as well as land patterns/footprints for both variations of the design. The PCB would then be populated with components according to the target market of the device.

### 6.5.1 Setting Up Variants



Variants are defined in the **Variant Manager** dialog box.

In the following example variants are entered for North American (NA) and European (EU) versions (that is, variants) of a design.

- To define circuit variants:
  1. Open a circuit in Multisim. In this example, the circuit name is “VariantTest”.
  2. Select **Tools/Variant Manager**. The **Variant Manager** dialog box appears.

- Highlight the circuit in the hierarchy that is displayed in the left pane. “Default1” is the default name for the initial variant.

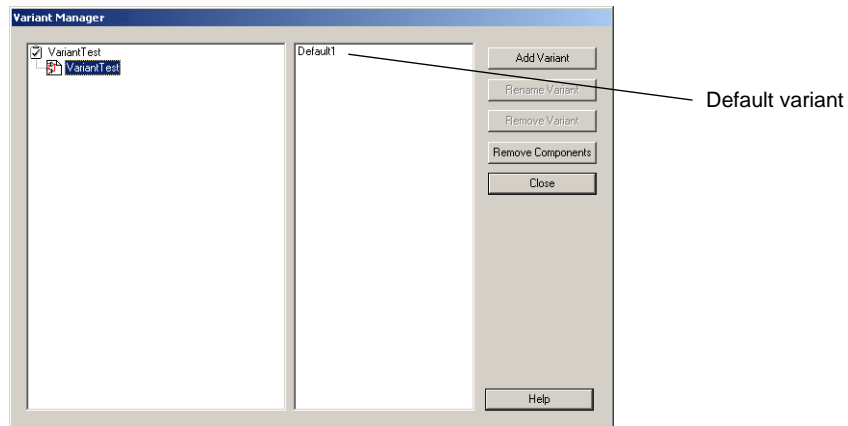

- Highlight “Default1” in the right pane. The **Rename Variant** button becomes active.
- Note** The **Remove Variant** button remains disabled, as there must be at least one variable assigned to each circuit. This button becomes active when there are two or more variants assigned to a circuit.
- Click **Rename Variant**. The **Rename Variant** dialog box appears.
  - Enter a new name for the variant (in this example, “NA”, for North America) and click **OK**. The name of the variant changes to the entered name in the right pane of the **Variant Manager** dialog box.
- The name of the European variant must now be entered.
- Click on **Add Variant** in the **Variant Manager** dialog box. The **Add Variant Name** dialog box appears.

8. Enter the name for the new variant (in this example, “EU” for Europe) and click **OK**. The **Variant Manager** dialog box now appears as follows.

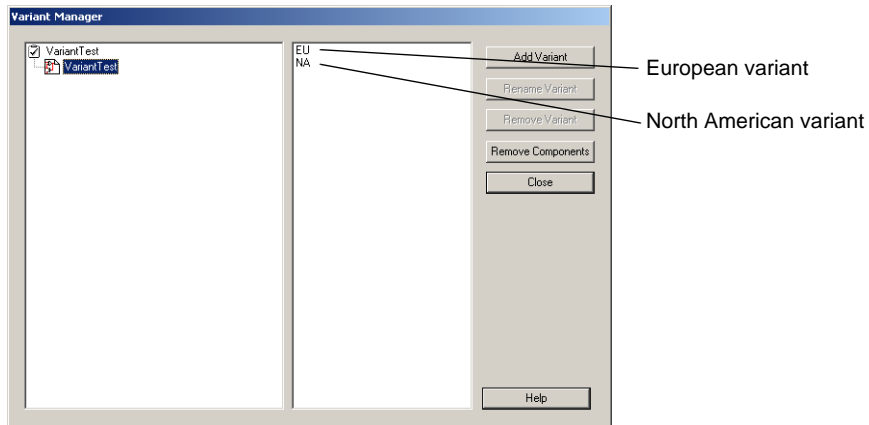

9. Click **Close** to return to the workspace.
- To delete variants from your circuit:
    1. Select **Tools/Variant Manager** to display the **Variant Manager** dialog box.
    2. Select the desired circuit in the left pane, and the variant you wish to delete in the right pane.
    3. Click **Remove Variant**. The highlighted variant is removed.
    4. Click **Close** to return to the workspace.
  - To rename variants in your circuit:
    1. Select **Tools/Variant Manager** to display the **Variant Manager** dialog box.
    2. Select the desired circuit in the left pane, and the variant you wish to rename in the right pane.
    3. Click **Rename Variant**. The **Rename Variant** dialog box appears.
    4. Enter the new variant name and click **OK** to return to the **Variant Manager** dialog box.
    5. Click **Close** to return to the workspace.

- To remove components that are not in any of the variants:
  1. Click on **Remove Components** in the **Variant Manager** dialog box. The **Components for Delete** dialog box appears.

If you do not wish to remove any of these components, click to remove the corresponding checkmark

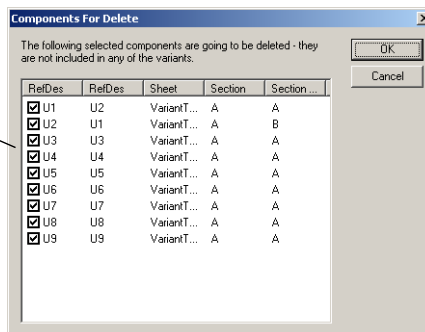

2. Click **OK** to remove the components from the workspace.

## 6.5.2 Placing Parts in Variants



This section continues the example of the variants for the North American (NA) and European (EU) markets used in “6.5.1 Setting Up Variants” on page 6-34.

- To place a part in a circuit containing variants:
  1. Place the parts in the usual manner, as documented in “4.4.1 Using the place component browser” on page 4-4.

After wiring the parts in this example, the circuit appears as follows. Note that at this point, each component is included in both the NA and EU variants of the circuit.

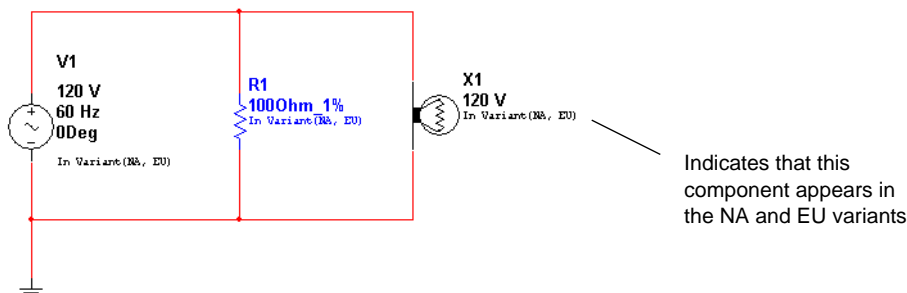

**Note** To display the variant status for the components, e.g., “In Variant (NA, EU)”, you must enable the **Variant Data** checkbox in the **Circuit** tab of the **Sheet Properties** dialog box.

2. Add a 220 V, 50 Hz power supply to the circuit. (This is for the EU variant).

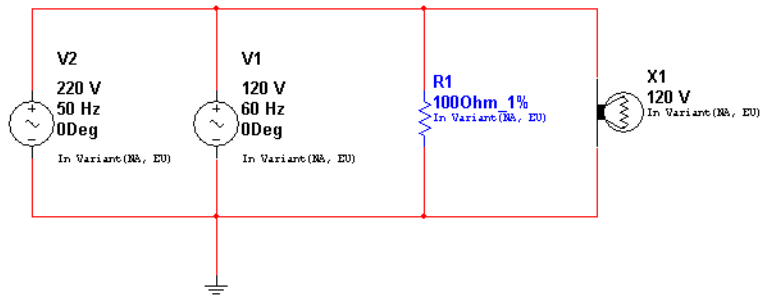

3. Add a 220V lamp to the circuit (also for the EU variant).

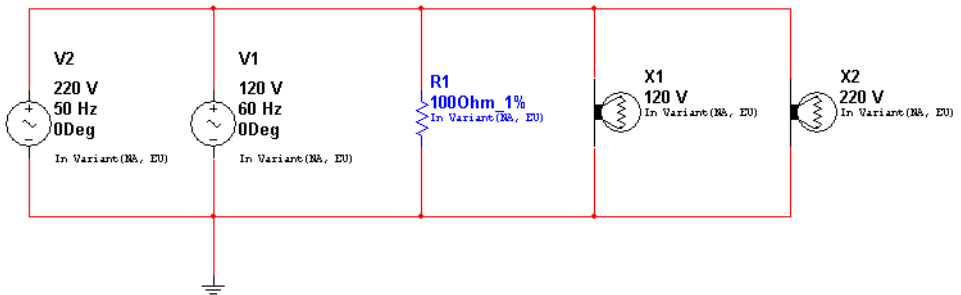

4. Assign variant status (in this case NA or EU) to each component as described below.

### 6.5.2.1 Assigning Variant Status to Components



This section continues the example of the variants for the North American (NA) and European (EU) markets used in “6.5.1 Setting Up Variants” on page 6-34. After you have set up these variants, you must set which component belongs to which variant.

➤ To assign components to variants:

1. Open the desired circuit as in the following example:

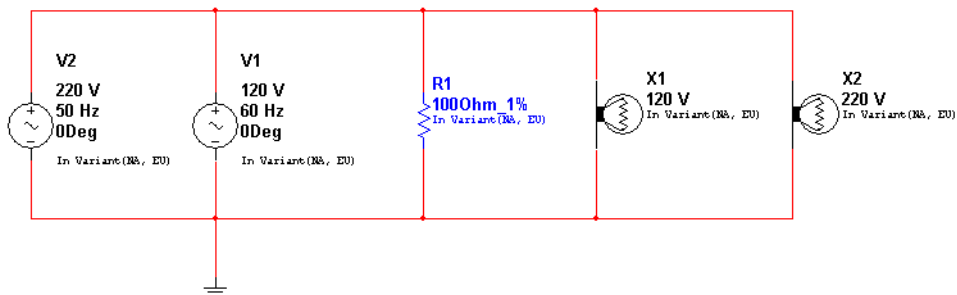

2. Double-click on a component (for example V2) to display the component's properties dialog box, and click on the **Variant** tab.

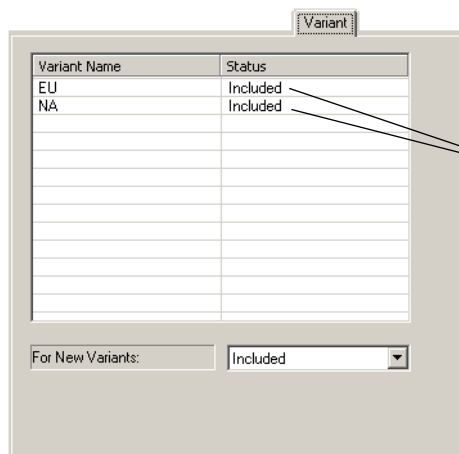

Indicates that the selected component is included in both the EU and NA variants of the circuit.

This is a 220V 50Hz power supply, so we want to include it in the EU (European) variant, but exclude it from the NA (North American) variant.

- Highlight the line that contains “NA” in the **Variant Name** column and then select **Excluded** from the **Status** column.

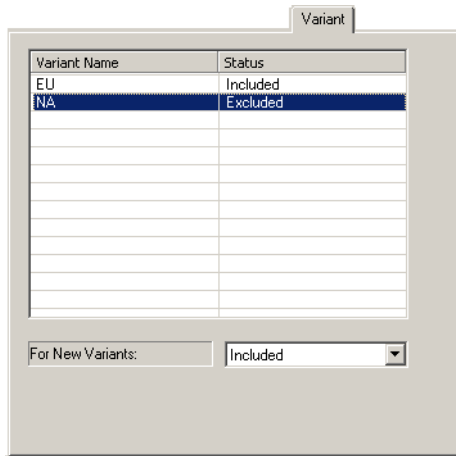

- Click **OK** to close the component’s properties dialog box.

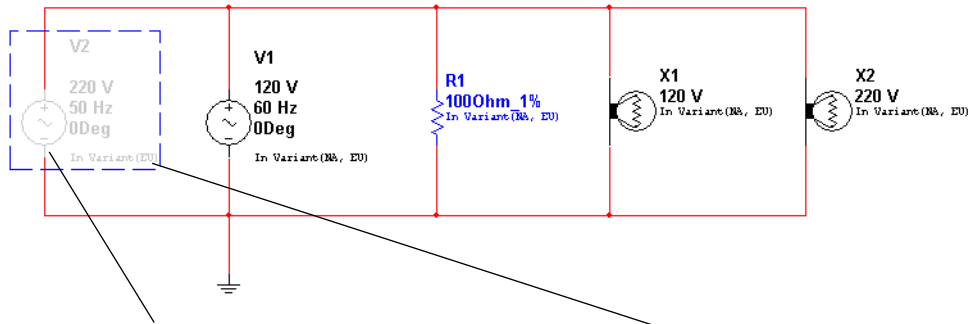

Component is dimmed, indicating that it is not present in the active variant. To set which variant is active on your workspace, see “6.5.2.3 Setting the Active Variant for Simulation” on page 6-44.

Label indicates component is only in the EU variant.

- Continuing with this example, double-click on V1 and select the **Variant** tab.  
This is a 120V 60Hz power supply, so we want to include it in the NA (North American) variant, but exclude it from the EU (European) variant.
- Highlight the line that contains “EU” in the **Variant Name** column and then select **Excluded** from the **Status** column.



7. Click **OK** to close the component's properties dialog box.

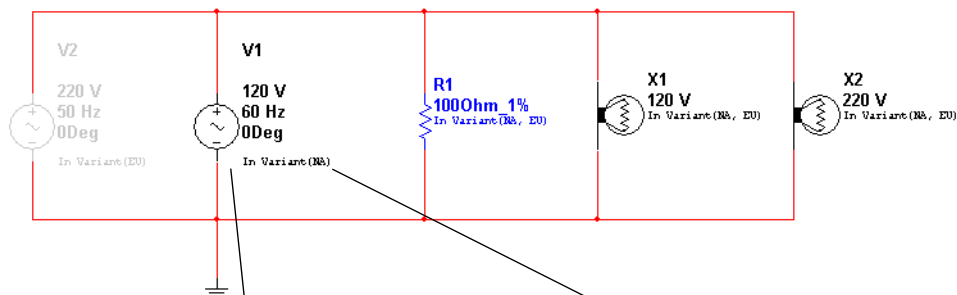

Component is not dimmed, indicating that it *is* present in the active variant. To set which variant is active on your workspace, see “6.5.2.3 Setting the Active Variant for Simulation” on page 6-44.

Label indicates component is only in the NA variant.

8. Set the variant status for the lamps X1 and X2, using the **Variant** tab as described in the preceding steps. X1 is rated at 120 V, so it is for the North American variant, and X2 is rated at 220V, so it is for the European variant.

When you are done, the circuit will appear as shown below:

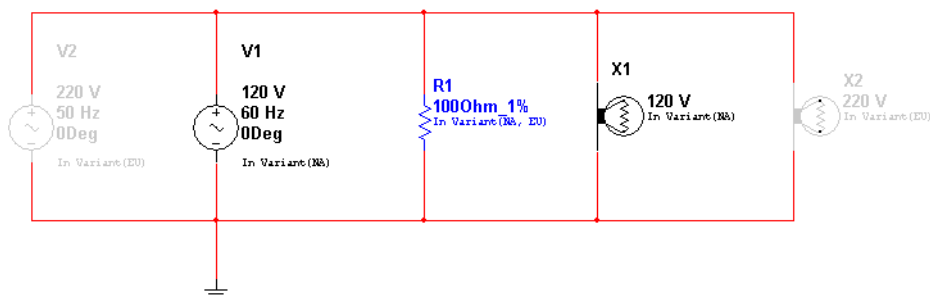

- To exclude a component from future variants of a circuit:
  1. Double-click on the desired component to display its properties dialog box, and click on the **Variant** tab.

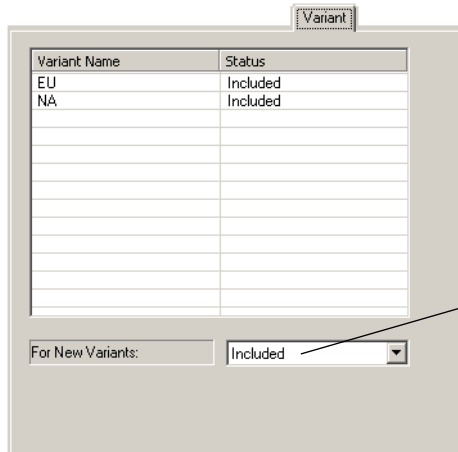

Indicates whether this component will be in any future variants of this circuit that you create. Default value is "Included".

2. Selected **Excluded** from the **For New Variants** drop-down list. This component will not be included in variants of this circuit that you may create in the future.

**Note** If you create a new variant after setting the status to **Excluded**, and then place an identical component from the database, it will still be included, as that is the default setting for new components.

**Tip** If you copy a component with variants from one circuit and paste it into a circuit with other variants, the pasted component will include the variants from the copied circuit. In this case, you may end up with a circuit that has variants (say USA and North America) that you may wish to combine. You can do this using the **Rename** button in the **Variant Manager** dialog box. Just rename one of them to match the other... for example rename USA to North America and the two variants will be merged into one variant called North America.

## 6.5.2.2 Assigning Variant Status to Nested Circuits

The active variant for a for a nested circuit (HB or SC) is whichever variant is mapped to its parent circuit's active variant.

- To assign variant status to a subcircuit or hierarchical block:



1. Right-click on the desired variant, and select **Include in Active Variant** from the pop-up.

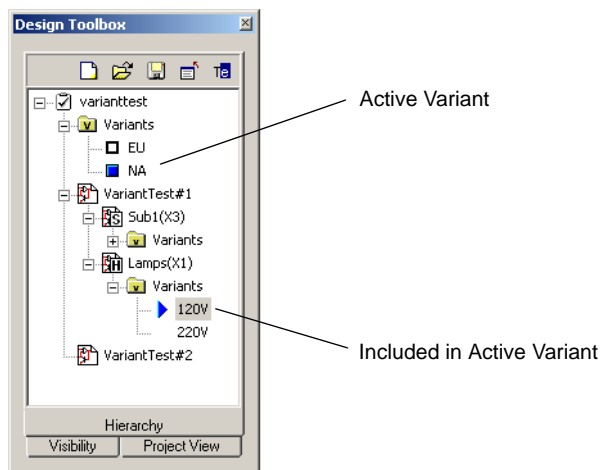
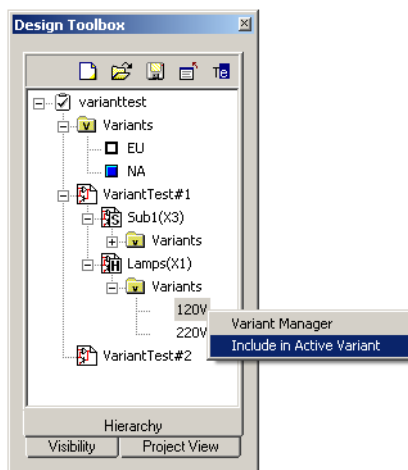

**Note** You can also assign the variant status in the **Variant** tab of the HB/SC's properties dialog box as shown below.

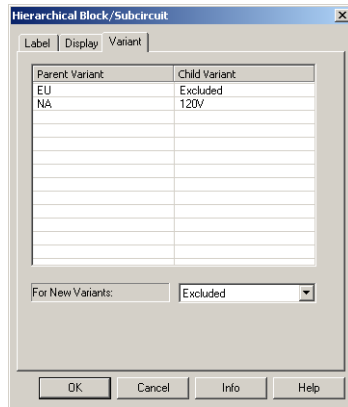

### 6.5.2.3 Setting the Active Variant for Simulation



This section continues the example of the variants for the North American (NA) and European (EU) markets used in “6.5.1 Setting Up Variants” on page 6-34.

Only one variant of a design can be simulated at a time. Consequently, you must select the variant for simulation from the available circuit variants as described below.

**Note** For details on simulation, refer to Chapter 9, “Simulation”.

#### Setting the Active Variant from the Design Toolbox

- To set the active variant from the **Design Toolbox**:
  1. Click on the **Hierarchy** tab in the **Design Toolbox**.

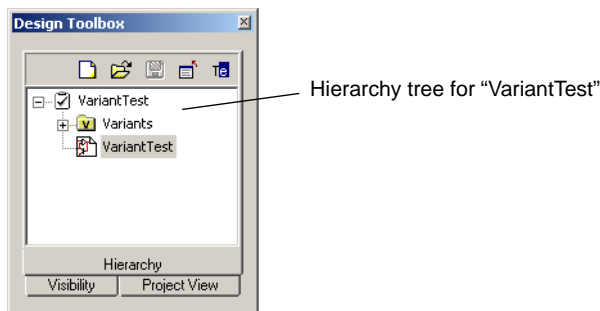

- Click on the “+” beside the **Variants** folder to open the folder.

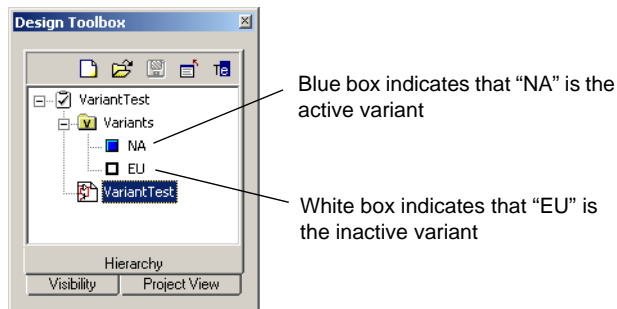

When NA is set as the active variant, the circuit appears as shown below.

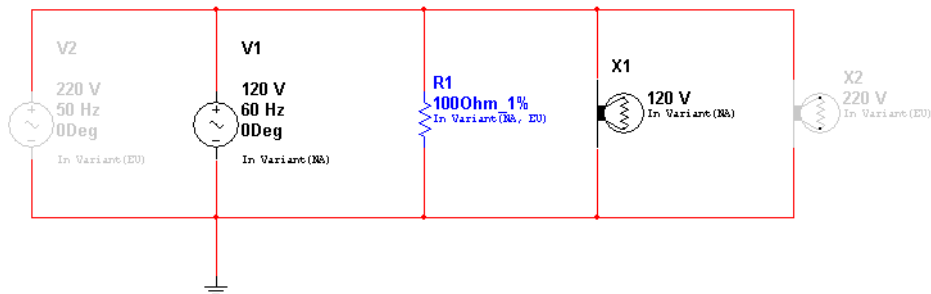

Only the active components will be included when the above circuit is simulated. The dimmed components are inactive, and will not be simulated.

- Right-click on the EU variant and select **Set Variant Active** from the pop-up that appears.

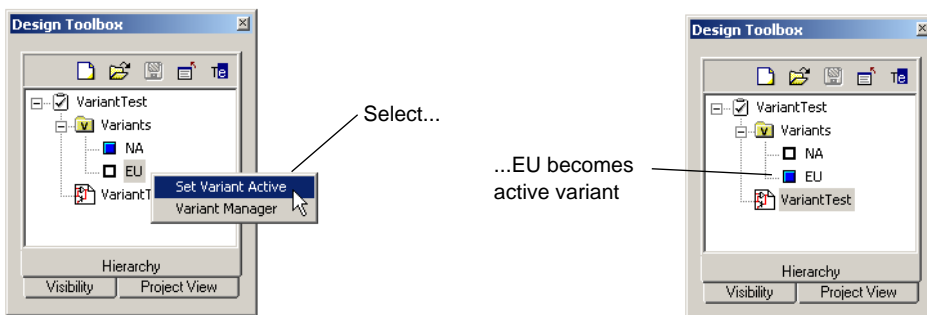

When EU is the active variant, the circuit appears as shown below:

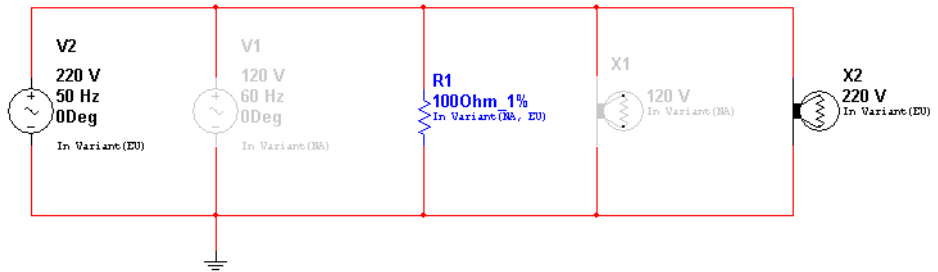

Only the active components will be included when the above circuit is simulated. The dimmed components are inactive, and will not be simulated.

### Setting the Active Variant from the Menu

- To set the active variant from the menu:
  1. Select **Tools/Set Active Variant**. The **Active Variant** dialog box displays.

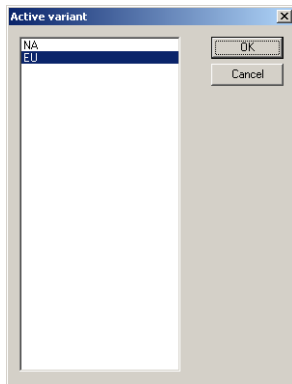

2. Highlight the variant you wish to make active and click **OK**.

## 6.6 Project Management and Version Control



In order to help manage the various files associated with a design, Multisim *Projects* may be used. A project is a collection of files. For example, all the circuit files making up a design may be grouped together in a project, as well as external design documentation (written in say, Microsoft Word), simulation output, reports, and PCB layouts generated with Ultiboard. In fact, any file at all may be grouped into a project.

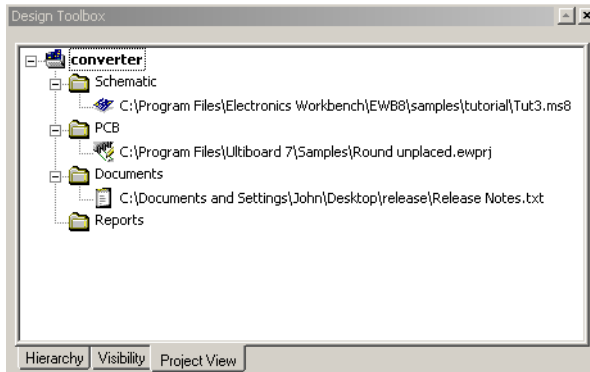

Facilities are provided to manage the files in a project as a whole: to version them, back them up, restore them, move them, and lock files within them so that no two designers accidentally work on the same file at the same time.

Note that even if a project contains a top-level circuit that references a hierarchical block, it is not necessarily the case that the hierarchical block is in that same project. This is a choice left entirely up to you. It may not be desirable to backup and version that hierarchical block with the circuit that references it if, for example, the hierarchical block is accessed from many different projects.

## 6.6.1 Setting up Projects

- To create a project for circuit files:
  1. Choose **File/New Project**. The **New Project** dialog box appears:

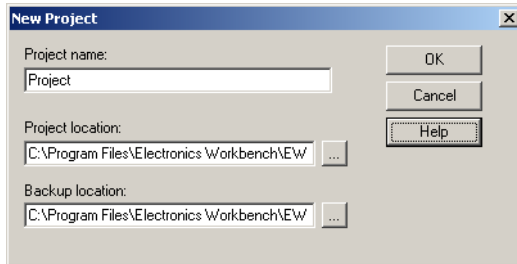

2. Specify the name for your project, the folder where the project files are to be stored, and the folder where backups of the project file are to be placed. If the folders do not already exist, they will be created. Click the button next to the location fields to browse for the desired location.
3. To save your project, click **OK**. To cancel, click **Cancel**. The **Project View** tab of the **Design Toolbox** appears.

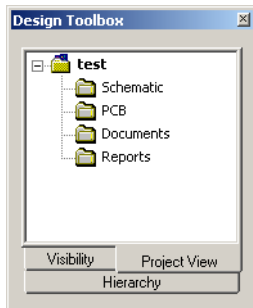

- To add circuit files to the project:
  1. Right-click on the **Schematic** folder in the project browser. From the pop-up menu that appears, choose **Add file**.
  2. A standard file selector window appears. Navigate to the location of the circuit file you want included in the project, select it and click **Open**.



3. The file is added to the project and its name appears in the project browser.

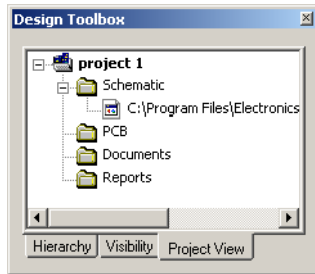

**Note** A circuit file can be part of more than one project.

- **Schematic** folder — for circuits drawn as schematics in Multisim or Multicap. May be multiple schematics as part of one project.
  - **PCB** folder — for circuits laid out in Ultiboard are logically the PCBs matching the schematic of the project.
  - **Documents** folder — for documents you wish to collect for the project. For example, MS Word description of project, Excel spreadsheet of costs, etc.
  - **Reports** folder — for reports generated by Multisim, for example, Bill of Materials, Netlist Report, etc.
- To add PCB, document or report files to a project, right-click on the folder for the desired type of file, for example, **PCB** and select **Add file**. In the file browser that appears, navigate to the desired file and click **Open**.
  - To remove a file from a project, right-click on the file and choose **Remove**.
  - To save a project, choose **File/Save Project**.
  - To close the project, choose **File/Close Project**. Closed projects can be accessed quickly by choosing **File/Recent Projects** and choosing from the displayed list.

## 6.6.2 Working with Projects

- To open a file within a project:



1. Right-click on the circuit file name in the **Project View** tab of the **Design Toolbox**.
2. From the pop-up menu that appears, choose either **Open** or **Open as Read-Only**. If the file is already open by another user, the **Open** command will not be available. If you open the file as read-only, you will not be able to save your changes to that file.

*Or*

1. Double-click on a circuit file in the project browser. If the file is not in use by another user, it will open. If it is in use, you are prompted to open it as read-only.

**Note** Files in use by another user are displayed with a different color in the project browser than files which are not in use.

➤ To open a project:

1. Choose **File/Open Project**. A standard Windows file browser appears.
2. If necessary, navigate to the correct folder and open the project file (with a .mp9 extension).

*Or*

1. Choose **File/Recent Projects** and select the project from the list that appears.
2. Once the project is open, the project browser shows a list of all the files within that project.

### 6.6.3 Working with Files Contained in Projects



You can lock, unlock, see summary information about any file in a project and set the file as the root using the pop-up menu.

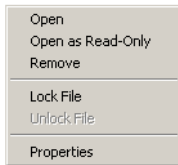

- To lock the file, preventing anyone else from opening it, right-click on the file name in the project browser and choose **Lock File** from the pop-up menu that appears.
- To unlock a file, freeing it for use by someone else, right-click on the file name in the project browser and choose **Unlock File** from the pop-up menu that appears.

- To see information on a file in a project, right-click on the file name in the project browser and choose **Properties** from the pop-up menu that appears.

A message box similar to the following appears:

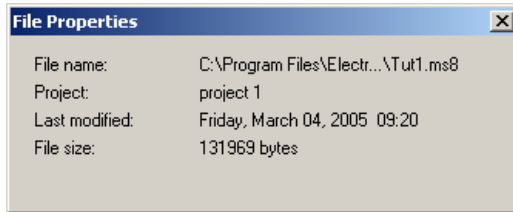

## 6.6.4 Version Control



At any given time, you can back up the contents of a project folder. You can then restore the folder as of that day and time.

- To back up a project folder:
  1. Choose **File/Version Control**. The **Version Control** dialog box appears:

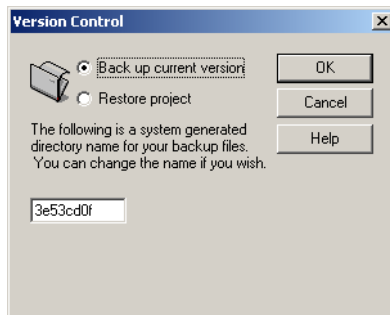

2. Select **Back up current version**.
3. The system generates a name for the backup, based on the system date. If you wish, you can change this by typing a new name in the field.
4. Click **OK**. The project file is backed up.

- To restore a backed up project folder:

**Note** Restoring a backed up project folder replaces the current folder. If you want to keep the current folder as well as the backed up version, save the folder to a new location or with a new name before proceeding.

1. Close all circuits associated with the project.
2. Choose **File/Version Control**. The **Version Control** dialog box appears.
3. Select **Restore project**. A dialog box listing the available backed up project folders appears.
4. Select the file you want and click **OK**.
5. You are prompted to confirm that you want to over-write the existing project folder contents with the backed up version.

# Chapter 7

## Components

This chapter introduces you to the underlying structure and organization of the Multisim 9 component database. It also explains how to access the database for parts and how to search the database for information.



Some of the features described in this chapter may not be available in your edition of Multisim 9. Such features have an icon in the column next to their description. Refer to the release notes for a list of the features in your edition.

The following are described in this chapter.

<b>Subject</b>	<b>Page No.</b>
<b>Structure of the Component Database</b>	7-2
Database Levels	7-2
Classification of Components in the Database	7-3
<b>Locating Components in the Database</b>	7-3
Browsing for Components	7-4
Searching for Components	7-4
<b>Types of Information Stored for Components</b>	7-6
Pre-Defined Fields	7-6
User Fields	7-7
<b>Component Nominal Values and Tolerances</b>	7-7
<b>Managing the Database</b>	7-8
Filtering Displayed Components	7-10
Managing Families	7-11
Modifying User Field Titles	7-12
Deleting Components	7-13
Copying Components	7-14
Saving Placed Components	7-16
Moving Components Between Databases	7-16
Displaying Database Information	7-17
Editing Components	7-17

Subject	Page No.
<b>Converting 2001 or V7 Databases</b>	7-18
<b>Updating Components from Databases</b>	7-19
<b>Merging Databases</b>	7-20

## 7.1 Structure of the Component Database

The Multisim component database is designed to hold the information necessary to describe any component. It contains all the details needed for schematic capture (symbols), simulation (models) and PCB layout (footprints), as well as other electrical information.

There are three levels of database provided by Multisim. The **Master Database** is read only, and contains components supplied by Electronics Workbench. The **User Database** is private to an individual user. It is used for components built by an individual that are not intended to be shared. The **Corporate Database** is used to store custom components that are intended to be shared across an organization. Various database management tools are supplied in order to move components between databases, merge databases, and edit them.

All the databases are divided into groups and then into families within those groups.

When a designer chooses a component from the database and drops it onto the circuit, it is a copy of the component that is placed onto the circuit. Any edits made to the component in the circuit do not affect the original database copy, or any similar components previously placed on the circuit. Likewise, any edits made the component in the database after a copy has been dropped do not affect the previously placed components, but will affect all subsequently placed ones.

When a circuit is saved, the component information is saved with it. On load, the user has the option to keep the loaded parts as is, to make copies to place into their user or corporate database, or to update similarly-named components with the latest values from the database.

### 7.1.1 Database Levels

Components are stored in three different database levels:

- the **Master Database** stores the components as originally shipped with Multisim; these remain the same and cannot be edited to ensure integrity of information.
- the **Corporate Database** stores components selected and, possibly, modified or created by an individual user or company/institution; these remain available to any other selected users.
- the **User Database** stores components modified, imported or created by you; these are



available only to you.

The **User Database** and the **Corporate Database** are empty when you first use Multisim. You can use the **User Database** to store frequently used components or components you create using Component editing (which is described in the following chapter).



The **Corporate Database** is primarily intended for companies/institutions (or individuals) who work on projects where components with specific attributes are shared within a group or project.

If you modify a component, thereby creating your own version, you must store it in either the **User Database** or **Corporate Database**. You cannot modify the **Master Database**.

You can build a circuit that contains components from any or all of the available databases.

## 7.1.2 Classification of Components in the Database

Multisim divides components into logical groups. Each group contains families of related components. The groups are listed below:

- Sources
- Basic
- Diodes
- Transistors
- Analog
- TTL
- CMOS
- Misc Digital
- Mixed
- Indicators
- Misc
- Electromechanical
- RF (for users with RF module)
- Electro-mechanical



## 7.2 Locating Components in the Database

You can locate components in a specific component family within a specific database by either browsing through the available data, which is the more common method, or by searching for a component that meets specific criteria. These functions are described in this section.

## 7.2.1 Browsing for Components

When you are placing a component, the browser dialog box that appears lets you browse for components anywhere in the Multisim database. For details, see “4.4.1 Using the place component browser” on page 4-4.

## 7.2.2 Searching for Components

Multisim comes with a powerful search engine to help you quickly locate components if you know some information about the type of component you need. Multisim searches its database for components that meet your criteria and presents them to you, enabling you to choose the component that most suits the needs of your application from the list of candidates.

- To perform a standard search of the database:
  1. Select **Place/Component** to display the **Select a Component** browser.
  2. Click **Search**. The **Search Component** dialog box appears:

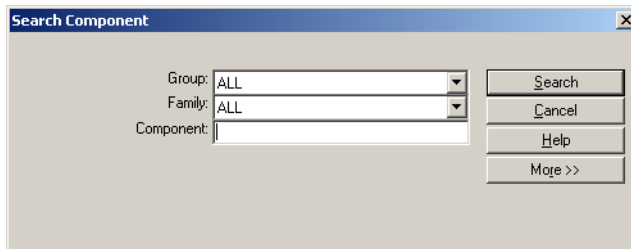

3. Optionally, click **More>>** to display additional search options.

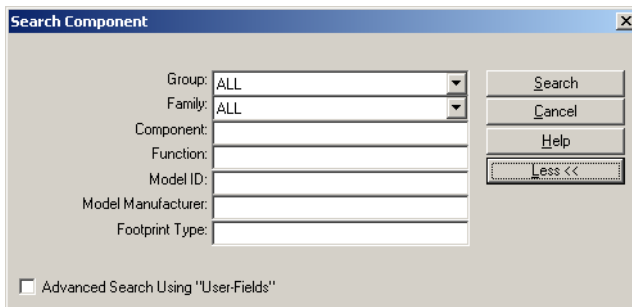

4. In the desired fields, enter your search criteria (you must enter at least one item). Enter alphanumeric characters, that is, text and/or numbers. Case is not considered, and you can use the “\*” wildcard to search on partial strings.



For example, in the **Footprint Type** field:

- “CASE646-06” finds only the exact string “CASE646-06”
- “\*06” finds any string ending with “06”
- “CASE\*” finds any string starting with “CASE”
- a “?” anywhere in the string will match exactly one character. For example, “CAS?” will match “CASE”, but not “CASE646-06”.

5. Click **Search**. When the search is complete, the **Search Component Result** dialog box appears.

**Tip** The more specific your search criteria, the smaller the number of matching components.

➤ To select a component from the search results:

When the search is complete, the **Search Component Result** dialog box appears, displaying information about the first component that matched your criteria. The **Component** list contains a list of all the components that matched your criteria. For example, using the search example above, the results look like this:

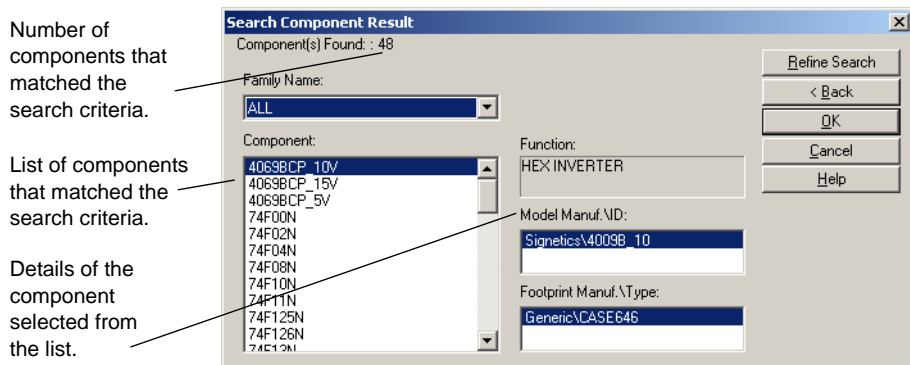

From the **Component** list, select the component you are interested in. To view information about any component found by the search, simply choose it from the list and the display fields change accordingly.

6. To place the selected component, click **OK**. You return to the **Select a Component** dialog box, where you can place the component by clicking **OK**.

You can refine your search if your initial attempt yielded a large number of items.



➤ To refine your search:

1. Click **Refine Search**. The following dialog box appears.

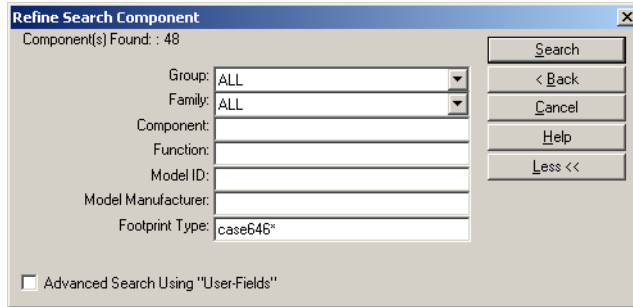

**Note** The original search parameters remain in the **Refine Search Component** dialog until a component is placed.

2. Enter desired parameters and click **Search**.

## 7.3 Types of Information Stored for Components

The Multisim databases store information about components in pre-defined fields (that is, fields that are pre-filled in Multisim) and user fields (that is, fields you can use to capture information that you want to record about a component).

Multisim also offers a detailed report of information about components, their models, and their packages. See “13.2 Component Detail Report” on page 13-5 for details.

### 7.3.1 Pre-Defined Fields

For each component, the following is stored in the **Master Database**:

- general information
- common parameters.

### 7.3.1.1 General Information

The following fields appear on the **Select a Component** browser:

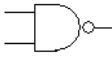
Field	Description	Example
Database	Name of Multisim database in which the component is stored.	User
Group	Name of the group to which the component belongs.	TTL
Family	Name of family to which the component belongs.	74S
Component	Name of the individual component.	74S00D
Symbol	Symbol used (either ANSI or DIN) to represent the component during schematic capture.	
Function	Describes the component.	QUAD 2-INPUT NAND
Model Manuf.\ID	Name of the company that manufactures the component and the component's ID.	Texas Instruments\74S00
Footprint Manuf.\Type	Footprint for the component (real components only) and the package type. Used in Ultiboard or other vendors' PCB layout products.	DO14

### 7.3.2 User Fields



In addition to the fields of data that are pre-defined and filled with information by Electronics Workbench before Multisim is shipped, you can also create your own fields of data to be stored about components. For details on setting up and entering data into user fields, see “8.10 Editing User Fields” on page 8-63.

## 7.4 Component Nominal Values and Tolerances

Multisim uses nominal values for each component in simulation.

When you want to observe circuit behavior that is more typical of real world results, you can choose to use tolerances instead. The components in this case randomly introduce variances to simulate the performance of actual physical components. Tolerance settings affect simulation results. For example, a 1 kohm resistor with a 10% variance could vary plus or minus 100 ohms.

- To set the tolerances to be used for components:
  1. Choose **Simulate/Global Component Tolerances**. If you have undeclared tolerances, you see a dialog box that allows you to set a percentage to be applied to undeclared tolerances in the circuit for each type of eligible component in the circuit. For example:

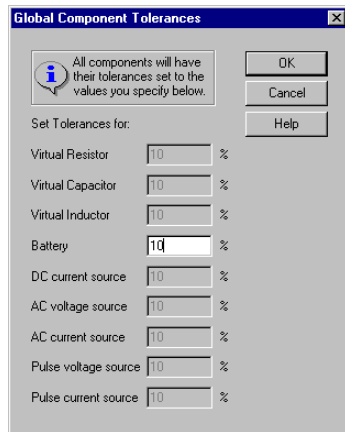

**Note** Only those components that exist in the active circuit can have values assigned to them in this dialog box. If a component is not in the active circuit, its corresponding field is disabled (greyed-out).

2. Enter the desired variances.
3. To cancel your changes, click **Cancel**. To save them, click **OK**. The simulation will now use random values as specified.

## 7.5 Managing the Database

The **Database Manager** dialog box lets you:

- add and remove component families from the **User Database** or **Corporate Database**. You cannot add or remove families in the **Master Database**.
- set up or modify user field titles for any database.
- add or change component toolbar button symbols for component families in the **User Database** or **Corporate Database**.

- To invoke the **Database Manager** dialog box:
  1. Click the **Database Manager** button on the **Main** toolbar.



*Or*

Choose **Tools/Database/Database Manager**.

The **Database Manager** dialog box appears.

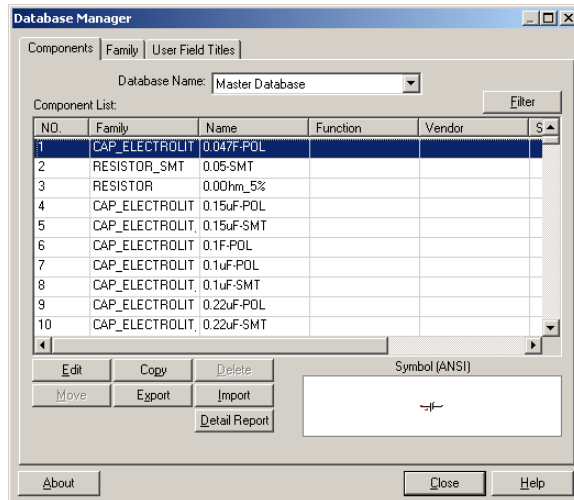

## 7.5.1 Filtering Displayed Components

➤ To filter the components that are displayed in the **Components** tab of the **Database Manager** dialog box:

1. Select the desired database from the **Database Name** drop-down list.

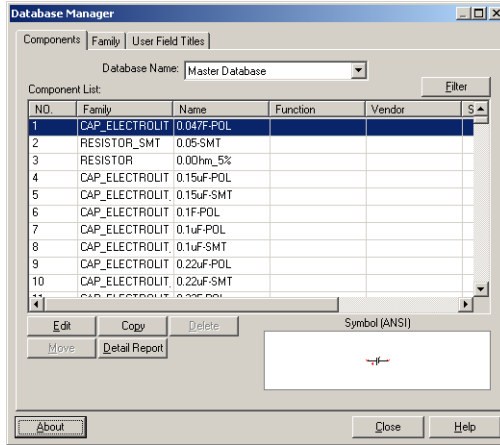

2. Click **Filter** to display the **Filters** dialog box.
3. Make selections as described below.

Select desired family. Use the CTRL and SHIFT keys with the left mouse button to select multiple items in the list, or select ALL to display all component families.

Select the User fields to display.

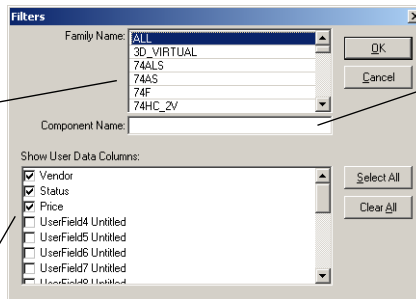

Type component name. You can also use wildcards.

Click to display all User fields.

Click to clear all checkboxes.

4. Click **OK**. The **Filters** dialog box closes and your selections are reflected in the **Components** tab of the **Database Manager** dialog box.

## 7.5.2 Managing Families

- To add a component family to the **User Database** or **Corporate Database** database:
  1. Select the **Family** tab in the **Database Manager** dialog box.
  2. In the **Database Family Tree** area, choose either the **Corporate** or **User Database**.
  3. Click **Add Family**. The **New Family Name** dialog box displays.

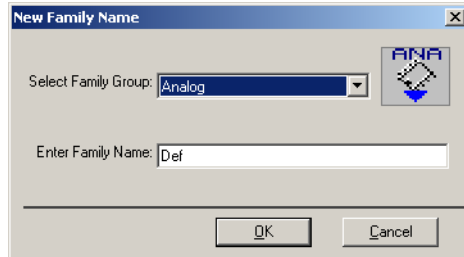

4. Enter the required information and click **OK**. You are returned to the **Database Manager** dialog box.
  5. A default icon of the group is automatically assigned to the new family. To change it, follow the procedure below.
  6. Your new family appears in the associated component group. For example, a new **Sample** family will appear in the **Analog** group of the database you selected.
- To load a component toolbar button:
    1. With the desired component family selected, click **Load**. You are prompted to navigate to the desired toolbar button file.
    2. Select the desired toolbar button file and click **Open**.
    3. The new toolbar button will be displayed in the **Database Manager** dialog box in the **Family** area and in the **Family Tree** area under the group where the family was added.
  - To edit the default family name button:
    1. With the desired component family selected, click **Edit**.
    2. Your paint program is launched and the bitmap file of the button is opened.
    3. Edit the bitmap file to your requirements and then save and close the paint program.
    4. The revised button will appear as the family name button.
    5. You can edit both the ANSI and DIN buttons by selecting the ANSI or DIN selector in the **Family** area of the **Database Manager**.

- To delete a component family from the **User Database** or **Corporate Database**.
  1. In the **Family** list, choose the Component Family from which you want to delete a component family.
  2. Click **Delete Family**. You are prompted to confirm your deletion.
  3. The Component Family is automatically removed.
- To delete empty families from the **User Database** or **Corporate Database**:
  1. Click **Delete Empty Families**. You are prompted to confirm your command to delete all empty family folders.
  2. To proceed click **Yes**. All empty family folders will be deleted from the **Family** list for the selected database.

### 7.5.3 Modifying User Field Titles

- To modify User field titles:
  1. Click the **User Field Titles** tab.

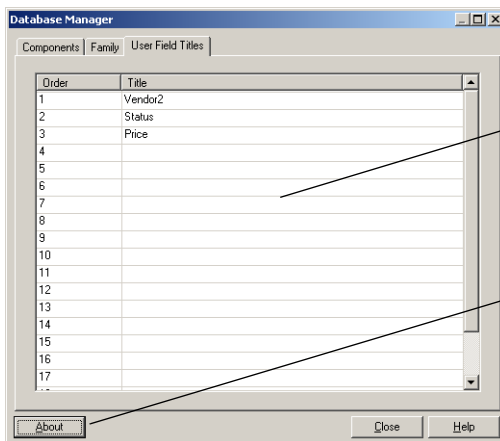

There are 20 User Fields that can be entered to provide User Specific information about the component

Click to display the Database Information dialog box.

2. Enter the desired information in the **Title** fields.
3. Click **Save**.

**Note** Modifying user field titles changes the titles for all databases, not only the selected database. User field titles can be changed again at any time.



## 7.5.4 Deleting Components

- To delete an existing component from a database:
  1. Click the **Database Manager** button on the **Main** toolbar.



*Or*

Select **Tools/Database/Database Manager**.

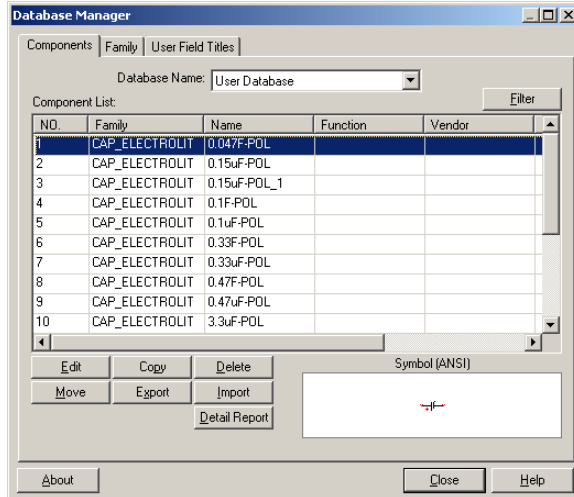

2. Select the **Components** tab.
3. From the **Database Name** drop-down list, choose the database containing the component you want to remove (**Corporate Database** or **User Database** only).

**Note** You cannot delete a component from the **Master Database**.

4. Select the components that you wish to delete.

Use the SHIFT and CTRL keys with the left mouse button to select multiple items in the list.

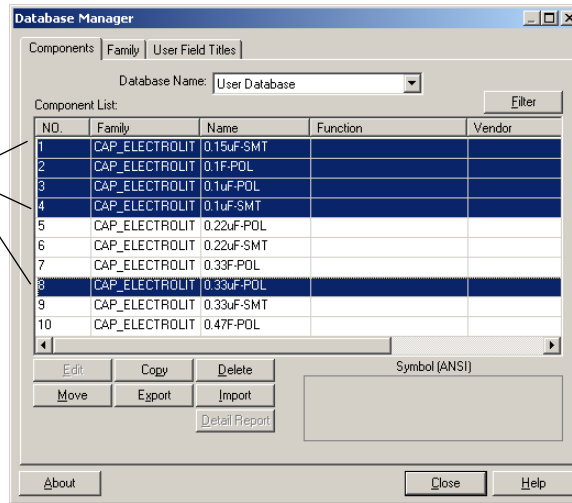

5. Click **Delete**. You are prompted to confirm the action.
6. Click **Yes**. The components are removed from the database.

## 7.5.5 Copying Components

- To copy an existing component:

1. Click the **Database Manager** button on the **Main** toolbar.



*Or*

Choose **Tools/Database/Database Manager**.

2. Select the **Components** tab in the **Database Manager** dialog box.
3. From the **Database Name** drop-down list, choose the database containing the components you want to copy.

4. Select the components that you wish to copy.

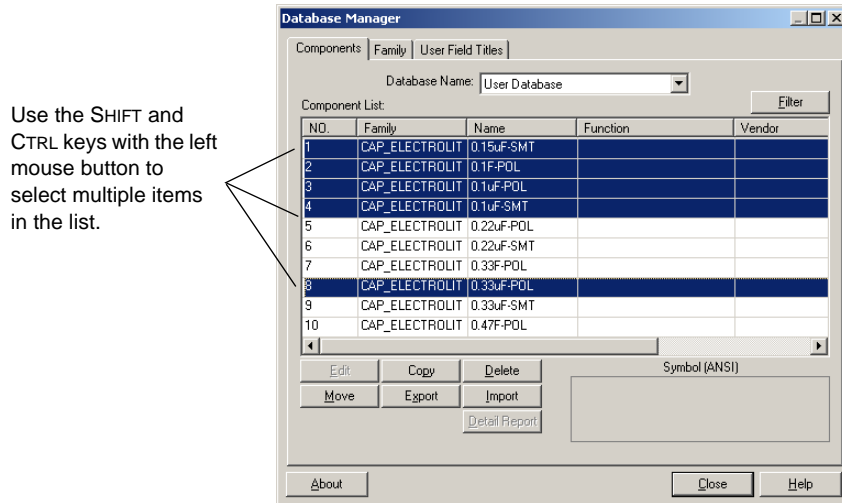

5. Click Copy. The Select Destination Family Name dialog box appears.

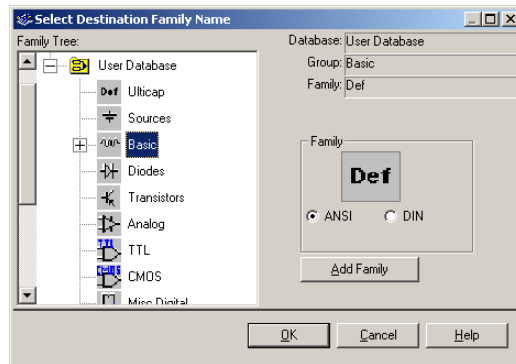

6. In the **Family Tree**, navigate to the database, group and family that you want to copy the component(s) to and click **OK**. You are returned to the **Components** tab in the **Database Manager** dialog box.

**Note** You can only copy components to the **Corporate Database** or the **User Database**.

7. When you are finished copying components, click **Close**.

## 7.5.6 Saving Placed Components

If you have made changes to a placed component (for example, changed the footprint) you can save the placed component to either the **User Database** or the **Corporate Database**.

- To save a placed component to the database:
  1. Select the component on the workspace and select **Tools/Database/Save Component to DB**. The **Select Destination Family Name** dialog box appears.
  2. Navigate to the desired location in either the **User Database** or the **Corporate Database**.
  3. If necessary, click **Add Family** to create a **Family** in the desired location and click **OK**. The following dialog box displays.

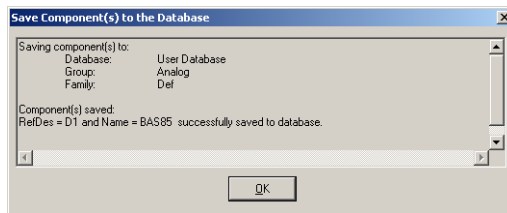

4. Click **OK** to close the dialog.

## 7.5.7 Moving Components Between Databases

- To move components from the **Corporate Database** to the **User Database**, or vice versa:



1. Choose **Tools/Database/Database Manager**.
2. Select the **Components** tab in the **Database Manager** dialog box.

3. Select the components that you wish to move.

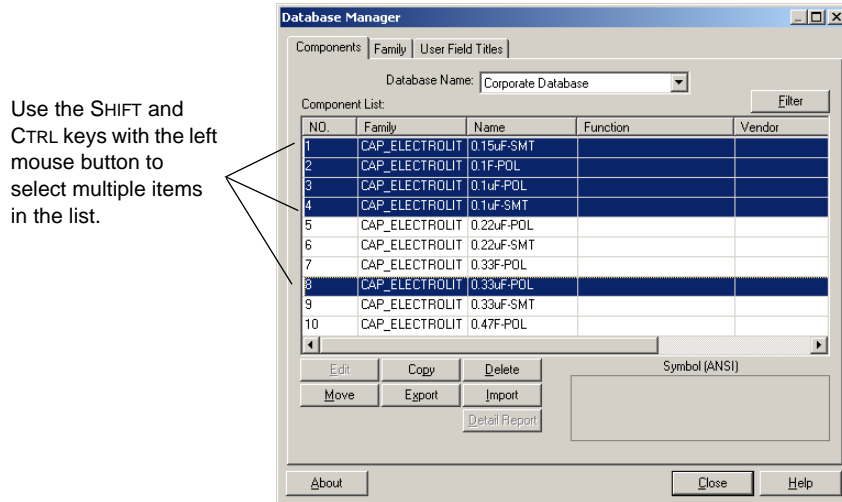

4. Click **Move**. The **Select Destination Family Name** dialog box appears.
5. Navigate to where you wish to place the moved component(s) and click **OK**.

## 7.5.8 Displaying Database Information

- To review database information:
  1. Click the **About** button in the **Database Manager** dialog box. The **Database Information** dialog box displays.
  2. To view version and other information, scroll down as desired.

## 7.5.9 Editing Components

The editing of components is discussed in detail in Chapter 8, “Component Editing”.

## 7.6 Converting 2001 or V7 Databases

If you are a user of Multisim 2001, Multisim 7 or Multicap 7, your **User Database** and **Corporate Database** must be converted to Multisim 9 format if you wish to use those components in Multisim 9.

**Note** If you are upgrading from Multisim 8, there is no need to convert these databases, as the formatting of the V8 and V9 databases is the same. However, it is recommended that you merge your existing V8 **User Database** and **Corporate Database** into Multisim 9 so that you have access to the components from these V8 databases. For details, see “7.8 Merging Databases” on page 7-20.

**Note** The option to convert the **Master Database** is not available, as a new **Master Database** is loaded when you install Multisim 9.

- To update your V6 (Multisim 2001) or V7 databases to Multisim 9:
  1. Select **Tools/Database/Convert Database**. The **Convert Database** dialog box appears.
  2. In the **Type** drop-down list select one of:
    - **Convert DB V7 ==> V9** — converts V7 components to V9 format. (Default setting).
    - **Convert DB V6 ==> V9** — converts V6 (Multisim 2001) components to V9 format.The title bar of the dialog box changes to reflect your selection.
  3. Click on **Select Source Database Names**. The **Select a Component Database Name** dialog box displays.
  4. Select the type of database that you wish to convert from the **Files of type** drop-down list:
    - **User** — user database.
    - **Corporate** — corporate database.
  5. Highlight the desired database file (the one you wish to convert) and click **Open**. You are returned to the **Convert Database** dialog box.
  6. Click **Start**. The following dialog box displays.

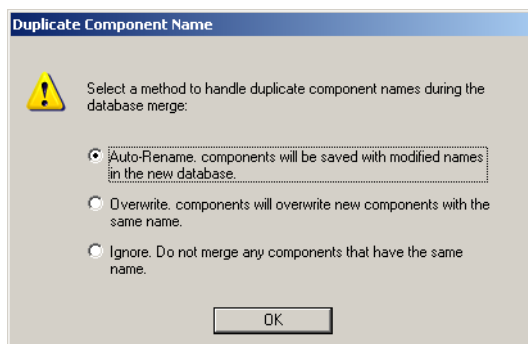

7. Select the desired option and click **OK**. The database is converted.
  - **Auto-Rename...** — Import and automatically rename the duplicate components.
  - **Overwrite...** — Replace the Multisim 9 components with V6 or V7 components.
  - **Ignore...** — Do not import V6 or V7 components with duplicate names.
8. Click **Close** to close the **Convert Database** dialog box.

## 7.7 Updating Components from Databases

If you open a circuit that was created in an older version of Multisim, you can update its components to match the current database.

➤ To update components:

1. Select **Tools/Update Circuit Components**. The following dialog displays.

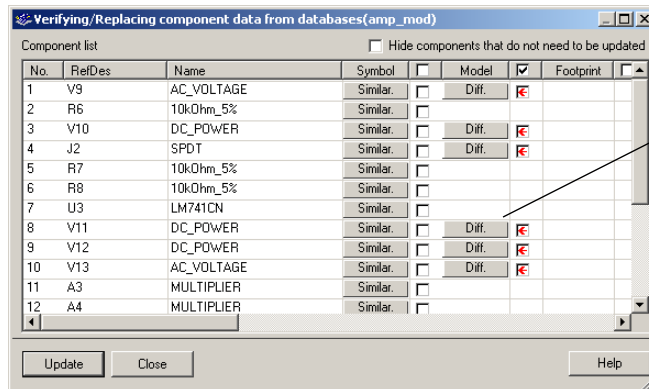

Click to display component difference.

If there are any differences, they will be indicated by a **Diff** button in the appropriate column and a red arrow.

2. If the **Diff** button appears in the **Model** column, you can click on it to show the difference in models between the component on the workspace and the model in the current database.
3. If the **Diff** button appears in the **Footprint** column, you can click on it show the difference between the component on the workspace and the footprint in the current database.

4. Select the components to update as indicated in the example below.

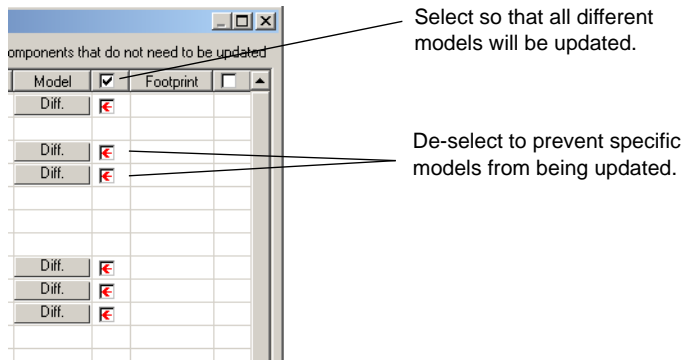

5. Click **Update** to update the selected components.

## 7.8 Merging Databases

- To merge the contents of another database into your **User** or **Corporate Database**:
  1. Select **Tools/Database/Merge Database**. The **Database Merge** dialog box appears.
  2. Click **Select a Component Database Name** and navigate to the database that you wish to merge into your database and click **Open**. You are returned to the **Database Merge** dialog box.
  3. Select the desired Target Database
  4. Click **Start**. The selected database is merged into your **User Database**.
  5. Click **Close**.



# Chapter 8

## Component Editing

This chapter explains how to create, edit, copy, or delete a component, and how to manage the Multisim 9 component database. It also explains how to load into the Multisim 9 database any models that you may have developed, obtained or purchased, and how to create simulation models using Multisim's Model Makers or code modeling.



Some of the features described in this chapter may not be available in your edition of Multisim 9. Such features have an icon in the column next to their description. Refer to the release notes for a list of the features in your edition.

### Editing a Component Pin Model

The following are described in this chapter.

<b>Subject</b>	<b>Page No.</b>
<b>Introduction to Component Editing</b>	8-2
<b>Adding Components with the Component Wizard</b>	8-4
Using an Existing Symbol File	8-11
<b>Editing Components</b>	8-12
<b>Editing a Component's General Properties</b>	8-14
<b>Editing a Component's Symbol</b>	8-15
Copying a Component's Symbol	8-16
Creating and Editing a Component's Symbol with the Symbol Editor	8-17
<b>Editing a Component's Model</b>	8-38
Adding a Model to a Component	8-40
Creating a SPICE Model for a Component	8-42
Loading an Existing Model	8-48
Modify a Model's Data	8-48
Copying the Model of One Component to Another	8-49
<b>Editing a Component Pin Model</b>	8-50

Subject	Page No.
<b>Editing a Component's Footprint</b>	8-51
Select a Footprint dialog box	8-52
Add a Footprint dialog box	8-57
Advanced Pin Mapping Dialog	8-58
<b>Editing a Component's Electronic Parameters</b>	8-62
<b>Editing User Fields</b>	8-63
<b>Creating a Component Model Using the Model Makers</b>	8-64
AC Motor	8-65
BJT Model Maker	8-65
Converters	8-77
Diode Model Maker	8-80
Transformers	8-84
MOSFET (Field Effect Transistor) Model Maker	8-90
Operational Amplifier Model Maker	8-97
Silicon Controlled Rectifier Model Maker	8-102
Zener Model Maker	8-106
<b>Creating a Model Using Code Modeling</b>	8-111
What is Code Modeling?	8-111
Creating a Code Model	8-112
The Interface File (Ifspec.ifs)	8-115
The Implementation File (Cfunc.mod)	8-121

## 8.1 Introduction to Component Editing

You can edit components in Multisim using the following methods:

- **Component Wizard** — used to create and edit new components. For details see “8.2 Adding Components with the Component Wizard” on page 8-4
- **Component Properties** dialog box — used to edit existing components and is accessed from the **Database Manager** dialog box. For details, see “8.3 Editing Components” on page 8-12.

You can modify any component stored in the Multisim component database. (See Chapter 7, “Components” for more information on this database.) For example, an existing component might now be available in a new package (originally pin-through hole, now surface mount). You can easily copy the component information and change only the package details to create this new component. You can also create your own component and place it into the database or load a component from another source.

You cannot edit the **Master Database**. However, you can copy components to the corporate or user database and then modify them as desired.

**Tip** Where possible, we recommend that you modify an existing, similar component, rather than create one.

Each component in the component database is identified by the following types of information, each of which are in a specific tab in the **Component Properties** dialog box. These are described in subsequent sections of this chapter.

- general information (such as name, manufacturer, date and author)
- symbol (pictorial representation of the component for schematic capture)
- model (information used to represent the actual operation/behavior of the component during simulation) — necessary only for a component that will be simulated.
- pin model (information used to represent the behavior of the pin during simulation)
- footprint (the package that Multisim uses when exporting a schematic containing this component to a PCB Layout package such as Ultiboard)
- electronic parameters of the component
- user fields (if used to further define the components)

In addition, components can be organized by using the **Database Manager** which lets you:

- add and remove component families from the **User** or **Corporate** databases
- modify user field titles for any database
- add and change family icons.

**Note** If you modify any information about a component in the **Master Database**, you must store the modified information in the **User Database** or **Corporate Database** database.

---

**Caution** If you modify information about any component in the **Corporate Database** or **User Database**, you are prompted for a new name for the component. If you do not give a new name, Multisim saves the changes to the original location, so the original **User Database** or **Corporate Database** component information is overwritten.

---

**Tip** You can also edit components that you have already placed on the workspace. This can be done using the component's properties dialog box (double-click on the component to display) and changing parameters in the various tabs. Changes made to placed components in this manner will not be reflected in the database. If you place the same component from the database, it will contain the parameters that it had *before* it was edited. Edits to individual components can also be made via the **Spreadsheet View**.

## 8.2 Adding Components with the Component Wizard

Multisim includes a **Component Wizard** to step you through the process of creating a component.

➤ To create a component:



1. Click the **Create Component** button in the **Main** toolbar.

*Or*

Choose **Tools/Component Wizard**.

The **Component Wizard** appears.

- Enter the component name, author and type.
- Enter a brief description in the **Function** box that will identify the component.
- Select the component simulation and layout footprint requirements for the component.
- To use the component for simulation and PCB layout, select **I will use this component for both simulation and layout (model and footprint)**.
- To use the component only for simulation, select **Simulation only (model)**.
- To use the component only for PCB layout, select **Layout only (footprint)**.

**Note** The number of steps you will have to complete will depend upon which component requirements you select in Step 1. If you will use the component for both simulation and layout, the wizard includes eight steps. If you will use the component for simulation only, the wizard includes seven steps, for layout only it includes six steps.

2. Click **Next**. Step 2 of the wizard appears.

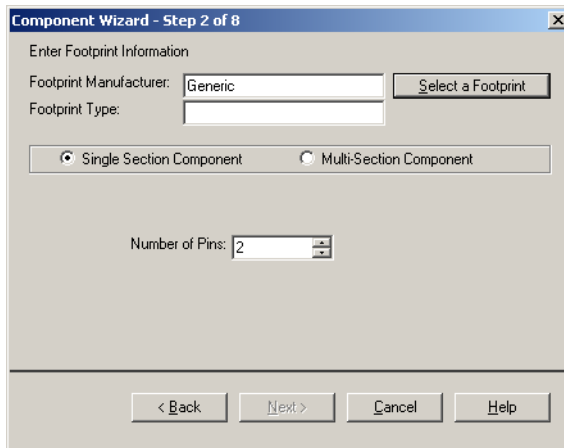

You will enter footprint information in this step.

3. Click **Select a Footprint**. The **Select a Footprint** dialog box appears, where you select a footprint from one of the databases.

- Select the desired **Database Name**, scroll down the list at the bottom of the dialog box and click the desired **Footprint**, for example, TO-39.

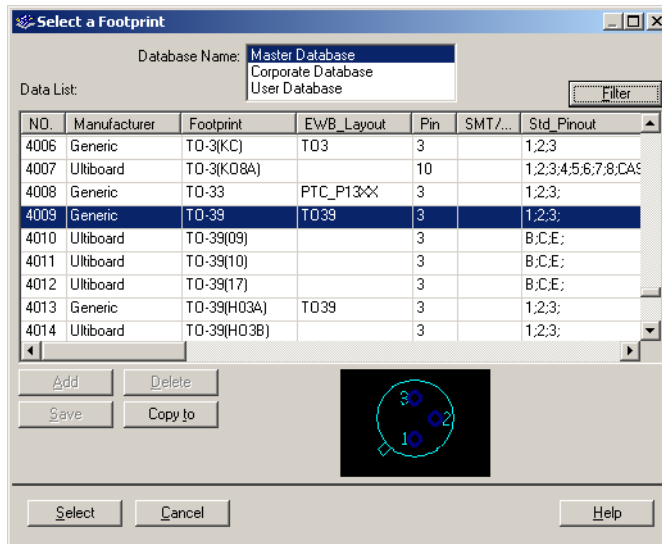

For more details on this dialog box, see “8.8.1 Select a Footprint dialog box” on page 8-52.

**Note** If you do not wish to assign a footprint at this time, select the database where the component will be stored and click on the **Add** button. The **Add a Footprint** dialog box appears. Type in a name in the **Footprint** field, for example, placeholder. Enter “Generic” in the manufacturer field and click **OK**. For details, see “8.8.2 Add a Footprint dialog box” on page 8-57.

4. Click **Select**. You are returned to the **Component Wizard**. The **Footprint Manufacturer** and **Footprint Type** fields have been populated based on the selected footprint.

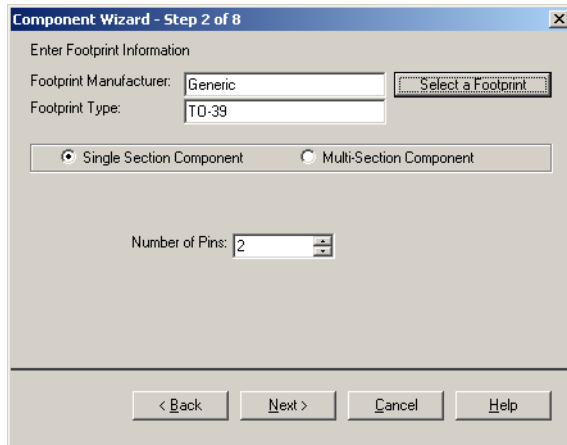

**Note** You can also enter values directly into the **Footprint Manufacturer** and **Footprint Type** fields instead of using the **Select a Footprint** dialog box. If you enter a value in either of these fields that do not exist in the **Master** or **User Database**, you will be prompted to confirm that you wish to add the information to a new footprint. If you select Yes, you will be presented with the **Add a Footprint** dialog box. For details, see “8.8.2 Add a Footprint dialog box” on page 8-57.

5. Specify the number of pins for the component (three, in this example). You have a choice of selecting a single or multi-section component and the number of pins for each.

6. Click **Next**. Step 3 of the wizard appears.

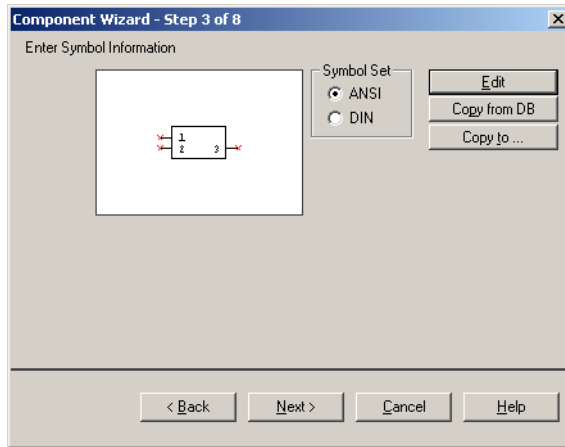

- The symbol you assign to this component appears when it is placed on the workspace.
- To modify the symbol information, click **Edit** and the **Symbol Editor** will be launched — see “8.5.2 Creating and Editing a Component’s Symbol with the Symbol Editor” on page 8-17 for more details.
- Selecting **ANSI** or **DIN**, allows you to use the symbol for the symbol set you prefer.
- By clicking **Copy To**, you can choose to have the same symbol used for both. You can also use this button to copy the symbol of a multi-section component to another section in that component. For details, see “8.5.1.1 Using “Copy To...”” on page 8-16.
- Click the **Copy From DB** button to browse the component database libraries if you wish to use an existing component symbol. For details, see “8.5.1 Copying a Component’s Symbol” on page 8-16.

7. Click **Next**. The following dialog box appears.

Click to add hidden pins: Power; Ground; Common.

Click in field and select whether to include or exclude pin from Electrical Rules Checking.

Click in field and select pin model type from drop-down list that appears.

Click in field and select desired Section for pin.

Symbol Pins	Section	Type	ERC Status
1	A	BIDIRECTIONAL	INCLUDE
2	A	BIDIRECTIONAL	INCLUDE
3	A	BIDIRECTIONAL	INCLUDE

8. To accept the symbol information displayed, click **Next**. Step 5 of the wizard appears.

Displays Advanced Pin Mapping dialog box

Symbol Pins	Footprint Pins	Pin Swap Group	Gate Swap Group
1	1		
2	2		
3	3		

The symbol and footprint pin mapping is needed for exporting to a layout package. A symbol pin is the name of the pin in the symbol, for example, Vcc. The footprint pin is the number or name of that pin on the footprint in PCB layout.

The symbol and footprint pins must accurately map in order to transfer correctly to PCB layout — see “Pins” on page 8-22 for a more detailed explanation of symbol and footprint pins.

- For each symbol pin, enter a corresponding footprint pin. The mapping information you enter here will be displayed in the **Footprint** tab of the **Component Properties**



dialog box.

- For advanced pin mapping options, click **Map Pins**. The **Advanced Pin Mapping** dialog box displays. For details, see “8.8.3 Advanced Pin Mapping Dialog” on page 8-58.

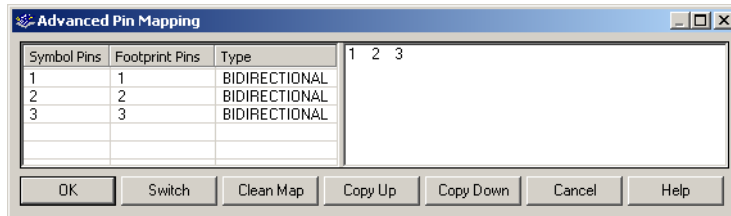

9. Click **Next**. If the component does not require simulation, skip to step 12. Otherwise, the following dialog box appears.

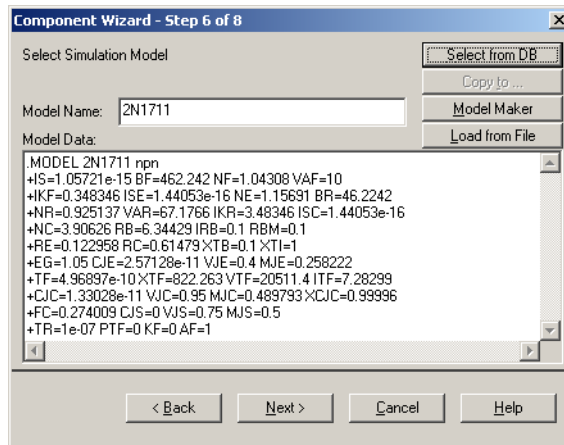

- The **Select from DB** button displays the **Select Model Data** dialog box, where you copy model data from an existing component. For details, see “8.6.5 Copying the Model of One Component to Another” on page 8-49.
- The **Copy to** button displays the **Select Target** dialog box. In this case you are copying model information from a selected section of a multi-section component to the target sections that you select in the **Select Target** dialog box. For details, see “8.5.1.1 Using “Copy To...”” on page 8-16. This would typically be used after using the **Select from DB** button to copy model data from another component. This model data will have only been copied to the selected section of the component. By using **Copy to**, you can copy the information into the remaining sections of the component.
- The **Model Maker** button displays the **Select Model Maker** dialog box. For more information, see “8.6.3 Loading an Existing Model” on page 8-48.
- The **Load from File** button displays a standard file browser where you navigate to, and select, the desired model file.



10.If necessary, click **Next** to display this dialog box.

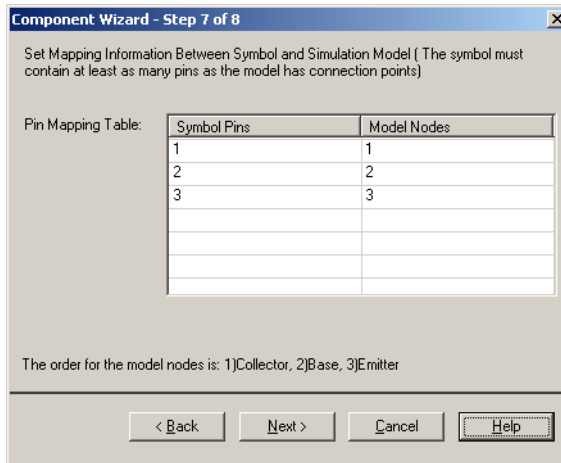

- For each symbol pin enter a corresponding number to connect to its respective nodes in the model. The mapping information you enter here will be displayed in the **Model** tab of the **Component Properties** dialog box.

11. Click **Next**. The dialog box that appears lets you indicate where you would like the new component that you just created to be saved. If there is no family in the group that you want to save the component, you can add a new family by clicking on the **Add Family** button. For details, see “7.5.2 Managing Families” on page 7-11.

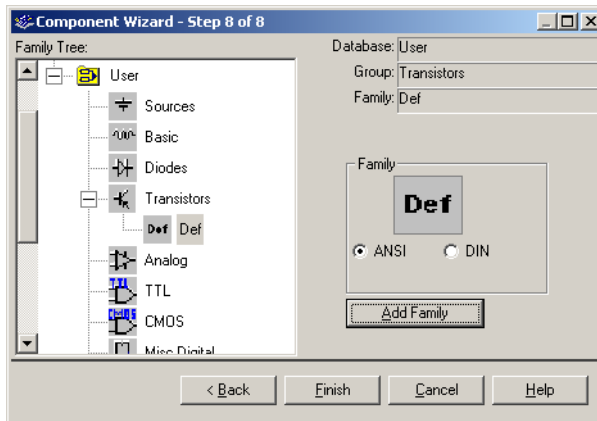

12.Navigate to the family where you want to save the component and click **Finish**. The component is saved in the selected family.

## 8.2.1 Using an Existing Symbol File

This section demonstrates how to use a symbol that you create in the **Symbol Editor** when creating a new component using the **Component Wizard**.

**Note** In this example, we will use `Bjt_new.sym` for the symbol's filename.

Multisim saves all symbols as `Sym_temp.sym` in the folder pointed to by your environmental variable `Temp`. Therefore, you must first locate this folder.

- To determine the environment variable:
  1. Start your computer.
  2. Follow the steps below for your operating system:
    - Windows XP**
      - Click Start, right-click on **My Computer** and select **Properties**.
      - Under the Advanced tab, click the **Environment Variables** button.
      - In the **User Variables For <user>** section, note the path for `TEMP` (e.g., `C:\Documents And Settings\User\Local Settings\Temp`)
    - Windows 2000**
      - Right-click on **My Computer** and select **Properties**.
      - Under the Advanced tab, click the **Environment Variables** button.
      - In the **User Variables For <user>** section, note the path for `TEMP` (e.g., `C:\Documents And Settings\User\Local Settings\Temp`)
    - Windows NT4**
      - Click Start, right-click on **My Computer** and select **Properties**.
      - Under the Environment tab, in the **User Variables For <user>** section, note the path for `TEMP` (e.g., `C:\Documents And Settings\User\Local Settings\Temp`)
- To create a symbol file:
  1. Start Multisim 9.
  2. Select **Tools/Symbol Editor**.
  3. In the symbol editor, create the desired symbol. For details, see “8.5.2 Creating and Editing a Component's Symbol with the Symbol Editor” on page 8-17.
  4. Select **File/Save As** and save the symbol into an easily accessible location (for example `C:\Temp>Bjt_new.sym`).
- To create a new component with the symbol saved in the above step:
  1. Select **Tools/Component Wizard**.
  2. Complete step 1 of the component wizard and click **Next**.

3. In step 2 of the component wizard, enter the desired footprint and number of pins.
4. In step 3 of the component wizard, click the **Edit** button. The Symbol Editor appears.
5. Select **File/Open** and open the symbol file saved earlier (C:\Temp>Bjt\_new.sym).
6. Select **File/Save As** and save the symbol as sym\_temp.sym in the folder determined for TEMP (e.g., C:\Documents And Settings\User\Local Settings\Temp).  
(You are overwriting the existing sym\_temp.sym).
7. Select **File/Exit**. Notice that the symbol now appears in the component wizard preview window.
8. Continue with the remaining steps in the component wizard. For details, see “8.2 Adding Components with the Component Wizard” on page 8-4.

## 8.3 Editing Components

- To edit an existing component:



1. Click the **Database Manager** button on the **Main** toolbar.

*Or*

Choose **Tools/Database/Database Manager**.

The **Database Manager** dialog box appears:

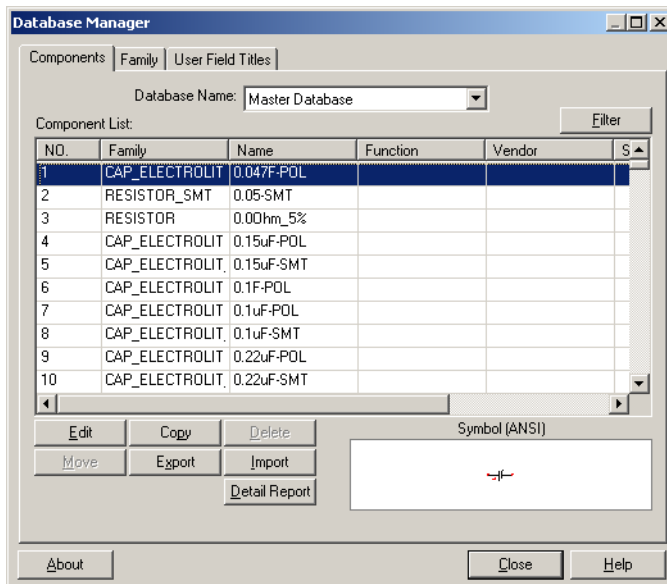

2. Select the **Component** tab if it is not selected.
3. In the **Component List**, select the component you want to edit.
4. Click **Edit**. The **Component Properties** dialog box appears, consisting of multiple tabs:

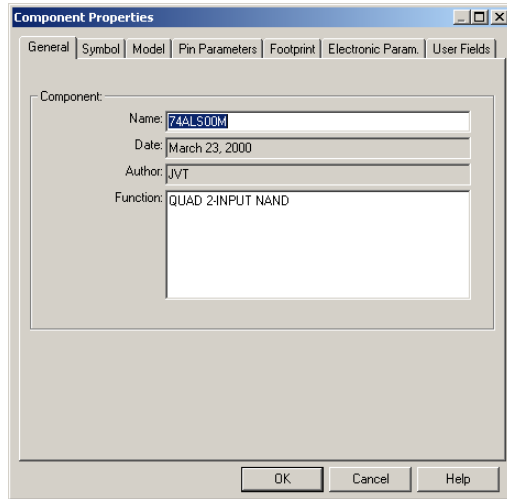

5. To edit component information in the various tabs, see:
  - “8.4 Editing a Component’s General Properties” on page 8-14
  - “8.5 Editing a Component’s Symbol” on page 8-15
  - “8.6 Editing a Component’s Model” on page 8-38
  - “8.7 Editing a Component Pin Model” on page 8-50
  - “8.8 Editing a Component’s Footprint” on page 8-51
  - “8.9 Editing a Component’s Electronic Parameters” on page 8-62
  - “8.10 Editing User Fields” on page 8-63.
6. Click **OK** from any of the tabs to save the edited component.



You are prompted to specify the location where you want the edited component saved.

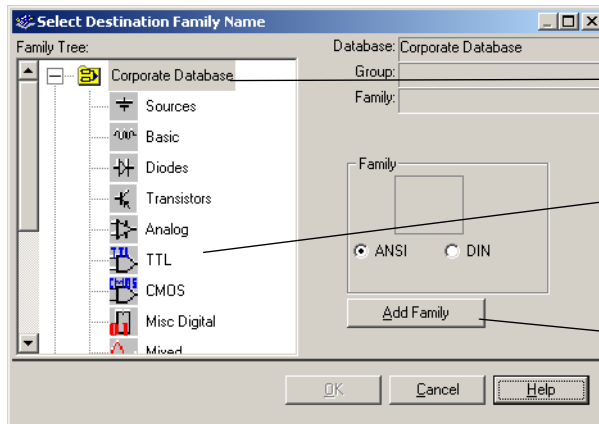

Choose the database in which you want the edited component stored.

Choose the family group in which you want the edited component stored and then click the family name. The OK button becomes active.

Click here to add a new family (prompted for group and name).

**Note** Remember, you cannot change information in, or add to, the **Master Database**, so you must make your changes in either the **Corporate Database** or **User Database**.

## 8.4 Editing a Component's General Properties

The **General** tab of the **Component Properties** dialog box allows you to modify the component's name and change the functional description. The date and author are drawn from system information and cannot be changed.

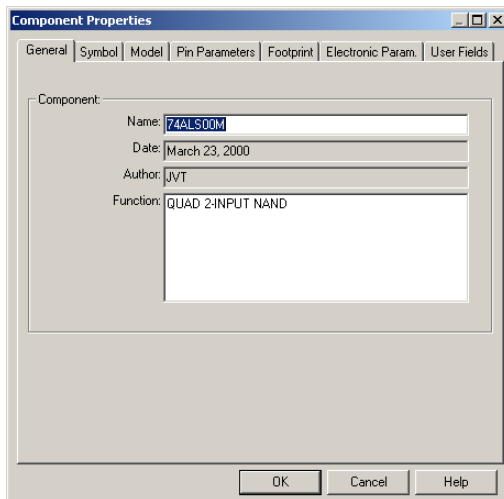

## 8.5 Editing a Component's Symbol

The **Symbol** tab of the **Component Properties** dialog box allows you to:

- edit a component's symbol
- give a component the same symbol as another component
- create a symbol for a component.

The symbol set (ANSI or DIN) of the displayed symbol.

Section of the component.

Read-only for existing pins. If the number of pins is changed, can be edited for new pins.

The symbol assigned to this component, if any. This is what will appear when this component is placed on the circuit window.

Shared/hidden pins that are common to all gates in the IC.

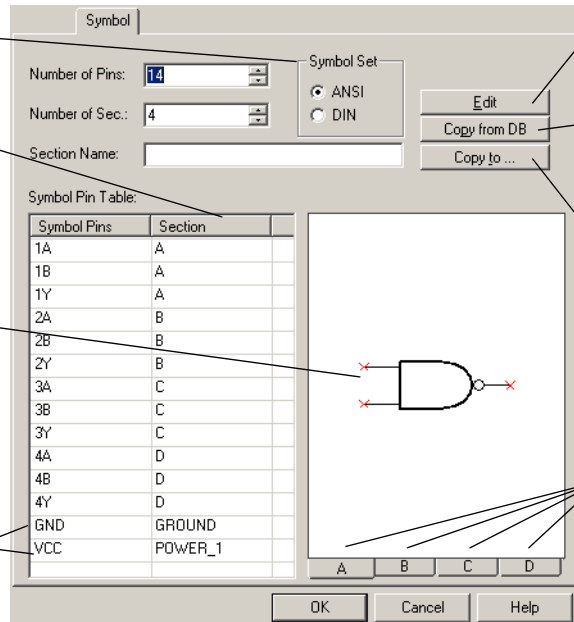

Use to edit a component's symbol.

Use to copy a symbol from another component.

Use to copy a symbol to another section

Click to display sections of component.

## 8.5.1 Copying a Component's Symbol

- To copy a symbol from another component:
  1. From the **Symbol** tab of the **Component Properties** dialog box, click **Copy from DB**. The **Select a Symbol** dialog box appears.

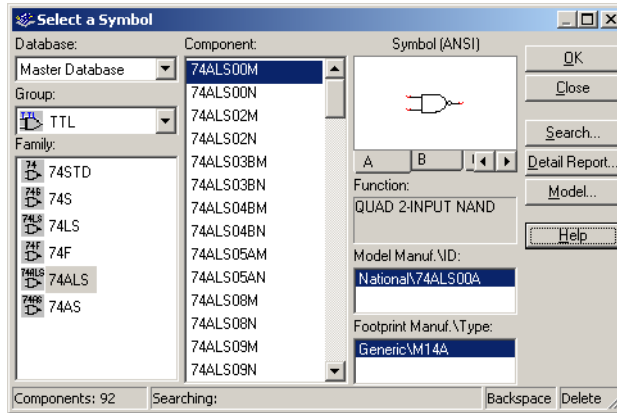

2. Navigate through the **Database**, **Group**, **Family** and **Component** lists to identify the component whose symbol you want to copy and click **OK**. (Click **Close** to cancel.) You return to the **Component Properties** dialog box, where the symbol associated with the selected component appears.
3. If you want to change the symbol set to be associated with this component, select **ANSI** or **DIN** from the **Symbol Set** box. The appropriate symbol appears in the upper part of the dialog box.
4. To confirm the association of this symbol with your component, click **OK**.

### 8.5.1.1 Using “Copy To...”

- To copy the symbol of a multi-section component to another section in that component:
  1. Click **Copy to** in the **Symbol** tab of the **Component Properties** dialog box.

*Or*

Click **Copy to** in the **Create Component Wizard - Step 3 of 7** dialog box.



The **Select Target** dialog box displays.

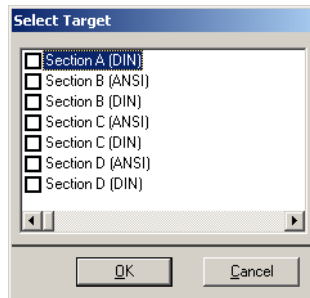

2. Select the sections to where you would like to copy the symbol and click **OK**.

**Note** The **Select Target** dialog box is also accessed from the **Select Simulation Model** dialog box of the **Create Component Wizard**. In this case you are copying model information from a selected section of a multi-section component to the target sections that you select in the **Select Target** dialog box.

## 8.5.2 Creating and Editing a Component's Symbol with the Symbol Editor

The **Symbol Editor** is a specialized graphics editor that allows you to create or modify a component's symbol. The **Symbol Editor** functions in the "normal" mode when editing component symbols in the database, or creating a new symbol. To edit the symbol for a single component in your active circuit, use the "In-Place Edit Mode". See "8.5.2.4 In-Place Edit Mode" on page 8-26 for details.

- To edit a component symbol:
  1. Double-click on the desired component and click **Edit Component in DB** to display the **Component Properties** dialog box.
  2. In the **Symbol** tab of the **Component Properties** dialog box, in the **Symbol Set** box, be sure you have selected the desired symbol set (**ANSI** or **DIN**).
  3. Click **Edit**. The **Symbol Editor** appears, displaying the selected symbol for you to edit.

The **Symbol Editor** looks like this:

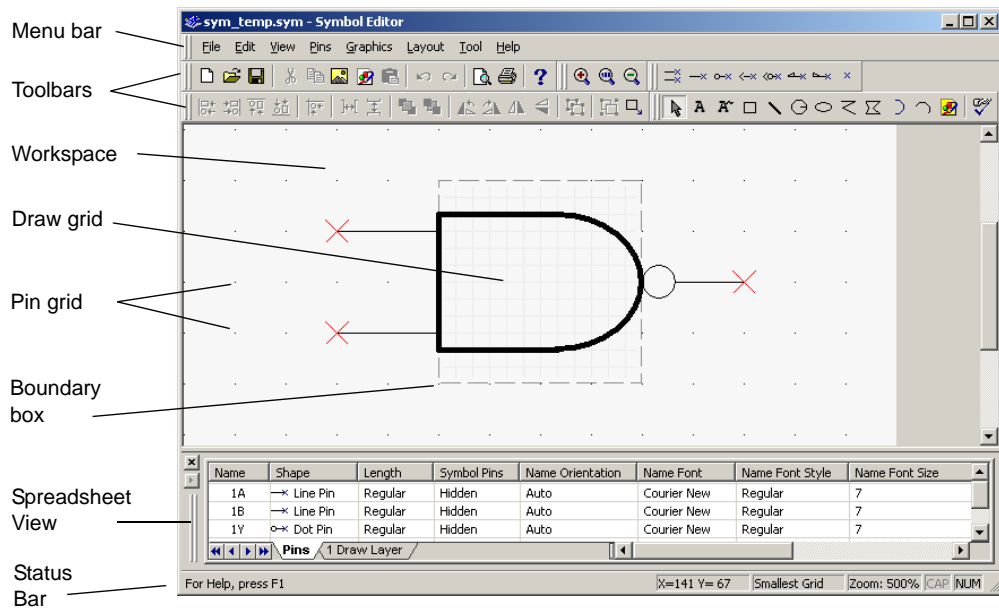

The **Symbol Editor** dialog box consists of:

- the **menu bar**, which contains the menus with their associated commands.
- the **toolbars**, which give quick access to the most commonly-used tools.
- the **workspace**, which is where you build or modify your symbols. The **Pin Grid** aids in the placement of pins. Its size cannot be adjusted. The **Draw Grid** aids in the placement of graphic elements inside the **Boundary Box**.
- the **Spreadsheet View**, which is where you find and edit various graphical primitives and pin parameters.
- the **Status Bar**, which gives information on the commands and actions associated with the position of the cursor.

The next sections describe the menus, toolbars and **Symbol Editor** functionality in more detail.

## 8.5.2.1 Symbol Editor Spreadsheet View

The **Spreadsheet View** is where you find and edit various symbol parameters. When you select an item on the workspace, it is highlighted in the spreadsheet, and vice versa. If you make a change to an item in the spreadsheet, it is reflected on the symbol in the workspace.

### Pins Tab

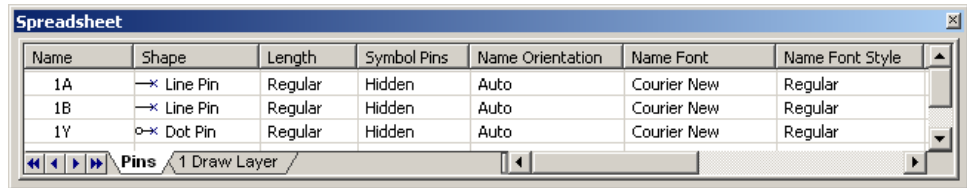

Column	Description
Name	The pin's name. You can perform full or partial negation on pin names by typing the ^ symbol on either side of any character that you wish to display a negation bar on the symbol.
Shape	Select a row and click in this field to display a list of pin types. Choices are: Line Pin; Dot Pin; Clock Pin; Dot-Clock Pin; Input Wedge Pin; Output Wedge Pin; Zero-Length Pin. Select the desired pin type. The symbol changes to reflect your selection. For details on pin types, see "Pins" on page 8-22.
Length	Select a row and click in this field to display a list of pin lengths. Choices are: Short (1 grid); Regular (2 grids); Long (3 grids); Extra Long (4 grids). If Zero-Length Pin is selected in the Shape field, the list of pin lengths is not available in the Length field.
Symbol Pins	Select a row and click in this field and select either Hidden or Visible to hide or show the pin name on the symbol.
Name Orientation	Select a row and click in this field to set the orientation of the pin's name on the symbol. Choices are: Auto; Vertical; Horizontal.
Name Font	The font used for the pin's name.
Name Font Style	The style of font used for the pin's name (for example, Bold).

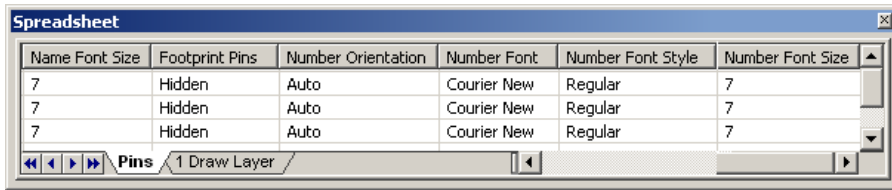

Column	Description
Name Font Size	The size of the font used for the pin's name.
Footprint Pins	Select a row and click in this field and select either Hidden or Visible to hide or show the footprint pin on the symbol.
Number Orientation	Select a row and click in this field to set the orientation of the pin number on the symbol. Choices are: Auto; Vertical; Horizontal.
Number Font	The font used for the pin's number.
Number Font Style	The style of font used for the pin's number.
Number Font Size	The size of the font used for the pin's number.

See also “ Pins” on page 8-22.

## Draw Layer Tab

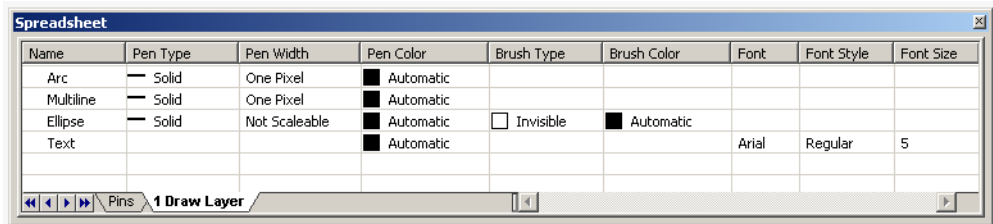

Column	Description
Name	The type of graphic element.
Pen Type	The appearance of lines for graphics elements, excluding placed text. Select a row and click in this field to display a list of pen types. Choices are: Solid; Dash; Dot; Dash-Dot; Dash-Dot-Dot; Invisible; Solid Inside Frame.
Pen Width	The width of the lines in graphic elements, excluding placed text. Select a row and click in this field to display a list of pen types. Choices are: Not Scalable; One Pixel; Two Pixels; Three Pixels; Four Pixels; Five Pixels.
Pen Color	The color of lines for graphic elements, including placed text. Select a row and click in this field to display a color palette.
Brush Type	The style of the fill in elements such as polygons, that have a fill. Select a row and click in this field to display a list of fill types. Choices are: Solid; Invisible; Horizontal; Vertical; Diagonal Downward; Diagonal Upward; Cross; Diagonal Cross.
Brush Color	The color of the fill in elements such as polygons, that have a fill. Select a row and click in this field to display a color palette.
Font	The font name, active for placed text elements only. Select a row and click in this field to display a list of fonts.
Font Style	The font style, active for placed text elements only. Select a row and click in this field to display a list. Choices are: Regular; Italic; Bold; Bold Italic.
Font Size	The font size, active for placed text elements only. Select a row and click in this field to display a list of sizes.

**Note** If objects are grouped using **Edit/Group**, their distinct names and properties will no longer appear. The name for any grouped object will appear as “Group”.

## 8.5.2.2 Working with the Symbol Editor

To use the **Symbol Editor** to create working symbols you need to be familiar with the elements required to make up a symbol in Multisim. The key elements needed for a symbol are:

- shape
- pins

These are described in more detail in the following sections.

### Shape

A symbol requires a shape to allow users to recognize its general function.

You use the drawing capabilities of Multisim's **Symbol Editor** to construct a shape that makes logical sense for the component you are creating or modifying. The simplest way to do this is to edit the shape of an existing component. Once this is done, you must add pins.

### Pins

There are three main parts to a pin. These are the:

- **Name** — This is the name of the pin and is usually the same as that given in the data sheet. For example, most digital parts have pins named “VCC” and “GND”. These names are used to identify the actual name of the pin in the symbol and must be unique. It is recommended that you use concise names as they display best on the workspace and on printed output.

There are two methods to handle components that have more than one pin with the same name:

1. Have one pin on the symbol that represents the duplicated pin (for example, “GND”) and match the footprint pins later to the one on the symbol pin.
  2. Add multiple pins that have the same basic name but append a digit to represent each occurrence. For example, you could represent multiple ground connections as GND1, GND2, GND3, etc.
- **Footprint Pin** — This is the pin number on the footprint for the device. This numbering will match the numbering used in PCB layout. Within the **Symbol Editor** you only choose whether to display the footprint pins by default, or not, and their orientation on the workspace.
  - **Shape** — The shape of the pin denotes the type of pin. Multisim provides seven pin shapes that you can use: Line Pin; Dot Pin; Clock Pin; Dot-Clock Pin; Input Wedge Pin; Output Wedge Pin; Zero-Length Pin. For details, see “Place Pin Toolbar” on page 8-36. The shapes are used for identification purposes and do not have any impact on the operation of the component.

**Note** The symbol and footprint pins must accurately map in order to transfer correctly to PCB layout.

This is a 555 timer's symbol shown in the Symbol Editor

Footprint Pin  
Symbol Pin

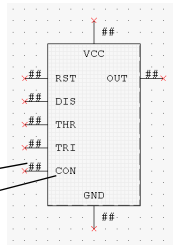

This is the 555 timer's symbol shown in Multisim's workspace

Footprint Pin  
Symbol Pin

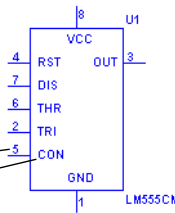

The relationship of the Footprint Pin to the Symbol Pin is mapped in the Footprint tab of the Component Properties dialog box. For details, see "8.8 Editing a Component's Footprint" on page 8-51

➤ To add a pin to a symbol:

1. Click on the desired pin type in the **Place Pin Toolbar**.
2. Click on the workspace where you want the pin to appear.

**Note** Pins cannot be placed on top of each other or on corners of the boundary box. If you attempt to do so, the cursor switches to a circle with a line through it, indicating that the action is prohibited.

➤ You can edit a pin's properties in the **Pins** tab of the **Spreadsheet View**. For details, see "Pins Tab" on page 8-19.

## Default Pin Options Dialog Box

For details on the **Pin Array Options** dialog box, go to “Pin Array Options Dialog Box” on page 8-25.

- To set up the default options for pins:

1. Choose **Pins/Default Pin Options**.

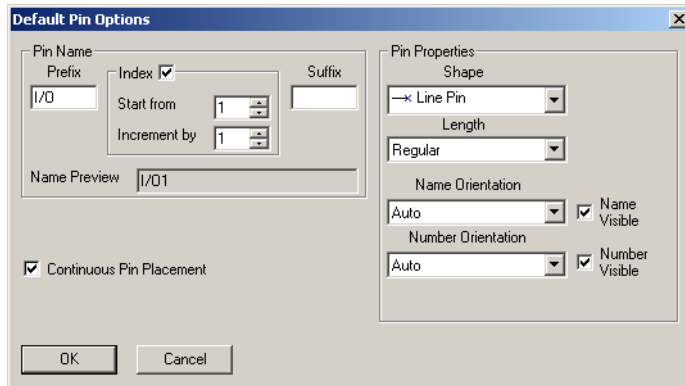

2. Set the options in the **Pin Name** box:
  - **Prefix** field—appears before the pin name. A preview of the prefix appears in the **Name Preview** field.
  - **Suffix** field—appears after the pin name. A preview of the suffix appears in the **Name Preview** field.
  - **Index** checkbox—enables the **Start from** and **Increment by** fields.
  - **Start from** field—the starting number for the pins.
  - **Increment by** field—the size of the steps between pin numbers.
3. Set the options in the **Pin Properties** box.
  - **Shape** drop-down list—the shape of the pin.
  - **Length** drop-down list—the length of the pin.
  - **Name Orientation** drop-down list—the orientation of the pin name. If you do not wish to show the pin name, turn off the **Name Visible** checkbox.
  - **Number Orientation** drop-down list—the orientation of the pin number. If you do not wish to show the pin number, turn off the **Number Visible** checkbox.
4. Optionally, enable the **Continuous Pin Placement** checkbox. This allows you to place pins one after the other, based on the parameters entered in the above steps, until the **ESC** button on your keyboard is pressed.



## Pin Array Options Dialog Box

➤ To place a pin array on a symbol:

1. Choose **Pins/Place Pin Array**.

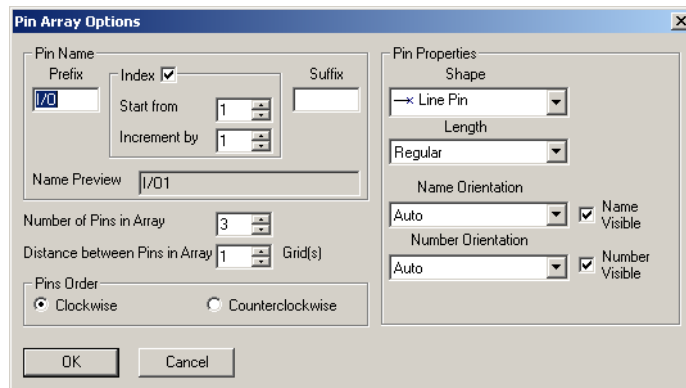

2. Set the options in the **Pin Name** box:

- **Prefix** field—appears before the pin names. A preview of the prefix appears in the **Name Preview** field.
- **Index** checkbox—enables the **Start from** and **Increment by** fields.
- **Start from** field—the starting number for the pins in the array.
- **Increment by** field—the size of the steps between pin numbers in the array.
- **Suffix** field—appears after the pin names. A preview of the suffix appears in the **Name Preview** field.

3. Enter the quantity of the pins desired in the **Number of Pins in Array** field.

4. Enter the spacing of the pins (in grids) in the **Distance between Pins in Array** field.

5. Set the options in the **Pins Order** box:

- **Clockwise** button—pins are placed in ascending order clockwise.
- **Counterclockwise** button—pins are placed in ascending order counter-clockwise.

6. Set the options in the **Pin Properties** box.

- **Shape** drop-down list—the shape of the pin.
- **Length** drop-down list—the length of the pin.
- **Name Orientation** drop-down list—the orientation of the pin name. If you do not wish to show the pin name, turn off the **Name Visible** checkbox.
- **Number Orientation** drop-down list—the orientation of the pin number. If you do not wish to show the pin number, turn off the **Number Visible** checkbox.

7. Click **OK** and place the array in the desired location. You are not permitted to place the array if there is insufficient space.

### 8.5.2.3 Enter Text Dialog Box

This dialog box is accessed from either the **Symbol Editor**, or **Title Block Editor**. For details on the **Title Block Editor**, see “5.3 Title Block Editor” on page 5-15.

- To enter text on a symbol or title block:
  1. Select **Graphics/Text**.

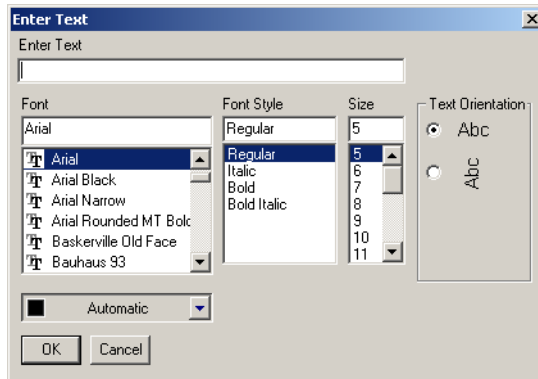

2. Type the desired text in the **Enter Text** field.
3. Change the formatting of the text as desired:
  - **Font** field—select desired font from the list or type in.
  - **Font Style** field—select desired style from the list.
  - **Size** field—select desired size from the list or type in.
  - **Text Orientation** box—select either horizontal or vertical orientation.
  - **Automatic** drop-down—optionally, select a new color from the pop-up that appears when you click on the down-arrow.
4. Click **OK** and place the text in the desired location.

---

**Caution** If the boundary does not contain sufficient space to place the text, it will be lost when you click the mouse.

---

### 8.5.2.4 In-Place Edit Mode

To edit the symbol for a component placed on the workspace, right-click on the component and select **Edit Symbol** from the pop-up that appears. The **Symbol Editor** launches in the **In-Place Edit Mode**.

You can edit the symbol via the menus, toolbars and spreadsheet.

In the **In-Place Edit Mode**, you can change the graphical elements of a symbol (e.g., the shape and placed text). You cannot add or remove pins as this would affect the footprint and model mapping.

**Note** The **In-Place Edit Mode** only changes the symbol for the selected component. It does not change the symbol for other components of the same value within the active circuit, or in the database.

## 8.5.2.5 Symbol Editor Menus

The **Symbol Editor** menus contain all the commands necessary to create and edit component symbols.

### File Menu

The following selections are available under the **File** menu:

Menu	Use
New	Opens a new untitled document in the Symbol Editor. If you already have one open, it will close first, after prompting you to save any changes.
Open	Opens an existing document in the Symbol Editor. If you already have one open, it will close first, after prompting you to save any changes.
Save	Saves changes to the active document.
Save As	Opens the standard Windows "Save As" dialog box where you can save the active document under a new or existing name.
Print Setup	Opens the standard Windows "Print Setup" dialog box where you can enter the desired parameters for your printer.
Print Preview	Opens the Print Preview dialog box, which shows the symbol in the active document with the best fit to the page. There are no other sizes available.
Print	Opens the standard Windows "Print" dialog box where you can enter the desired printing properties and print the symbol. The symbol is printed with the best fit to the page. There are no other sizes available for printing the symbol.
Exit	Closes the Symbol Editor and returns you to the main Multisim screen. Before exiting, you are prompted to save changes, if any, to the active document.

## Edit Menu

The following selections are available under the **Edit** menu:

Menu	Use
Undo	Undoes the previous action.
Redo	Redoes the previous "undo" action.
Cut	Removes the selected element(s) from the workspace and places them on the clipboard.
Copy	Places a copy of the selected element(s) on the clipboard. Note that pin names cannot be copied separately.
Paste	Places a copy of the element(s) on the clipboard on the workspace at the cursor's location. If the clipboard contains pins and graphical elements, only the graphical elements will be pasted.
Delete	Removes the selected element(s) from the workspace. They are <i>not</i> placed on the clipboard.
Copy As Picture	Copies the symbol on the workspace to the clipboard as a metafile. For use with Winword.
Copy As Bitmap	Copies the symbol on the workspace to the clipboard as a bitmap image. For use in PaintBrush.
Select All	Selects all of the elements on the workspace.
Flip Horizontal	Flips the selected element(s) horizontally. Does not apply to pins.
Flip Vertical	Flips the selected element(s) vertically. Does not apply to pins.
Rotate 90 Clockwise	Rotates the selected element(s) 90 degrees clockwise. Does not apply to pins.
Rotate 90 Counter CW	Rotates the selected element(s) 90 degrees counter-clockwise. Does not apply to pins.
Snap To Grid	Snaps the selected element(s) to the Draw Grid that is found within the symbol's boundary box. Does not apply to pins.
Group	Places selected elements in one group. Does not apply to pins.
UnGroup	Returns an element that was made using the Group command, back to its individual elements. Does not apply to pins.

Menu	Use
Bring To Front	Brings selected element(s) to the foreground on the workspace. Other element(s) appear behind them. Does not apply to pins.
Send To Back	Sends selected element(s) to the background on the workspace. Other elements appear in front of them. Does not apply to pins.
Resize Boundary Box	Places a cursor at the lower-right side of the boundary box. Drag it to the desired location to resize the boundary box. You cannot make the boundary box smaller than the elements that it contains or smaller than is required for the pins that are attached to it.

## View Menu

The following selections are available under the **View** menu:

Menu	Use
Toolbars	Toggles the following toolbars on and off: Standard Toolbar; Zoom Toolbar; Draw Tools; Pin Place Toolbar; Drawing Toolbar.
Spreadsheet	Toggles the spreadsheet view on and off. For details, see "8.5.2.1 Symbol Editor Spreadsheet View" on page 8-19.
Status Bar	Toggles the Status bar at the bottom of the screen on and off.
Show Pin Grid	Toggles the Pin Grid, which displays outside of the Boundary Box on the workspace, on and off. For consistency throughout Multisim, the Pin Grid's size cannot be changed.
Show Draw Grid	Toggles the Draw Grid, which displays inside the Boundary Box, on and off.
Draw Grid Size	Sets the size of the Draw Grid, which displays inside the Boundary Box. The choices are: No Grid; Smallest Grid; Small Grid; Regular Grid; Large Grid.
Zoom In	Magnifies the element(s) in the workspace.
Zoom Out	Reduces the viewing size of the element(s) in the workspace.
Zoom 100%	Displays the items in the workspace at their normal viewing size. This is the size that they will be displayed at in Multisim. When the Symbol Editor first opens, the magnification is set to 200%.

Menu	Use
Center By Mouse	When viewing the workspace at high magnifications, you can use this command to center the image on the workspace. Select Center By Mouse and then click on the spot that you would like to be placed at the center of the workspace.
Redraw	Redraws all elements in the workspace.

## Pins Menu

The following selections are available under the **Pins** menu. For details on pin types, see “Pins” on page 8-22.

Menu	Use
Select	Use to select element(s) on the workspace by clicking and dragging the mouse.
Line Pin	Places a line pin on the workspace.
Dot Pin	Places a dot pin on the workspace.
Clock Pin	Places a clock pin on the workspace.
Dot-Clock Pin	Places a dot-clock pin on the workspace.
Input Wedge Pin	Places an input wedge pin on the workspace.
Output Wedge Pin	Places an output wedge pin on the workspace.
Zero-Length Pin	Places a zero-length pin on the workspace.
Place Pin Array	Displays the Pin Array Options dialog box where you enter parameters to place a pin array on the workspace. For details, see “Pin Array Options Dialog Box” on page 8-25.
Default Pin Options	Displays the Default Pin Options dialog box where you enter the default settings for the various pin types. For details, see “Default Pin Options Dialog Box” on page 8-24.

## Graphics Menu

The following selections are available under the **Graphics** menu:

Menu	Use
Text	Displays the Enter Text dialog box where you enter and format text to be placed on the workspace. For details, see "8.5.2.3 Enter Text Dialog Box" on page 8-26.
Line	Draws a line on the workspace.
Multiline	Draws a multiline on the workspace.
Half Ellipse Arc	Places half of an ellipse on the workspace. Click once at the desired starting point and click again where you wish the diameter of the ellipse to end. As you move the cursor, a dotted outline of the ellipse appears. Click again to place the outer point of the arc at the desired location.
Segment Arc	Places an arc on the workspace. Click once to place the center point of the arc, click again to place the outer diameter point. As you move the cursor, a dotted outline of the arc appears. Now move the cursor and click to place the arc's end point.
Bezier	Places a bezier curve on the workspace. Click to place the start of the curve, then move the cursor on the workspace. As you move the cursor, a dotted outline of the bezier curve appears. Click to place the end point of the bezier, then move and click the cursor twice more to form the final shape of the bezier.
Rectangle	Places a rectangle on the workspace.
Circle	Places a circle on the workspace. Click to place the center of the circle, then move the cursor on the workspace. As you move the cursor, a dotted outline of the circle appears. When the circle is the desired size, click to place it on the workspace.
Ellipse	Places an ellipse on the workspace. Click to place the center of the ellipse, then move the cursor on the workspace. As you move the cursor, a dotted outline of the ellipse appears. When the ellipse is the desired shape and size, click to place it on the workspace.
Polygon	Places a polygon on the workspace. Click to place the polygon's corners and right-click to finish.
Bitmap	Places a bitmap image on the workspace. Click to display a standard Windows "Open" dialog box, where you can select the desired bitmap.

**Note** Graphical primitives such as lines and rectangles can only be placed inside the boundary box. If you attempt to place them outside of the boundary box, the cursor will change to a circle with a line through it, indicating that the action is prohibited.

## Layout Menu

To align two or more graphic elements, use one of the following selections from under the **Layout/Align** menu:

Menu	Use
Left	Left aligns the selected elements.
Horiz. Center	Horizontally centers the selected elements.
Right	Right aligns the selected elements.
Top	Aligns the selected elements along their top edges.
Vert. Center	Vertically centers the selected items.
Bottom	Aligns the selected elements along their bottom edges.

## Tool Menu

The following selection is available under the **Tool** menu:

Menu	Use
Check Symbol	Confirms that the symbol has no errors, such as duplicate pin names.
Customize	Displays the Customize dialog box. For details, see "3.6 Customizing the Interface" on page 3-37.

## Help Menu

The following selections are available under the **Help** menu:

Menu	Use
Help Topics	Displays the helpfile.
About Symbol Editor	Displays a splash window with information about the Symbol Editor.



## Pop-up Menus

Depending on where you right-click in the Symbol Editor, different pop-up menus appear.

Right-clicking from a *menu* displays a pop-up which allows you to toggle the following toolbars on and off: Standard Toolbar; Zoom Toolbar; Draw Tools; Pin Place Toolbar; Drawing Toolbar.

Right-clicking in the *workspace* displays a pop-up that contains: Cut; Copy; Paste; Show Draw Grid; Draw Grid Size; Snap To Grid; Flip Horizontal; Flip Vertical; Rotate 90 Clockwise; Rotate 90 Counter CW. For details on these, see “Edit Menu” on page 8-28.







### 8.5.2.6 Toolbars







The toolbars give access to the most commonly-used tools.

#### Standard Toolbar



The buttons in the **Standard** toolbar are described below:



Button	Description
	Open button. Opens a new untitled document in the Symbol Editor. If you already have one open, it will close first, after prompting you to save any changes.
	Open button. Opens an existing document in the Symbol Editor. If you already have one open, it will close first, after prompting you to save any changes.
	Save button. Saves changes to the active document.
	Cut button. Removes the selected element(s) from the workspace and places them on the clipboard.
	Copy button. Places a copy of the selected element(s) on the clipboard.
	Paste button. Places a copy of the element(s) on the clipboard on the workspace at the cursor's location.

Button	Description
	Copy As Picture button. Copies the symbol on the workspace as a metafile.
	Copy As Bitmap button. Copies the symbol on the workspace as a bitmap image.
	Undo button. Undoes the previous action.
	Redo button. Redoes the previous “undo” action.
	Print Preview button. Opens the Print Preview screen, which shows the symbol in the active document with the best fit to the page. There are no other magnifications available.
	Print button. Opens the standard Windows “Print” dialog box, where you can enter the desired printing properties and print the symbol. The symbol is printed with the best fit to the page. There are no other magnifications available for printing the symbol.
	About Symbol Editor button. Displays a splash screen with information about the Symbol Editor.

## Zoom Toolbar











The buttons in the Zoom toolbar are described below.





Button	Description
	Zoom In button. Magnifies the elements on the workspace.
	Zoom 100% button. Displays the items in the workspace at their normal viewing size. This is the size that they will be displayed at in Multisim. When the Symbol Editor first opens, the magnification is set to 200%.
	Zoom Out button. Reduces the viewing size of the element(s) on the workspace.

## Draw Tools Toolbar



The buttons in the **Draw Tools** toolbar are described below:





Button	Description
	Select button. Use to select element(s) on the workspace by clicking and dragging the mouse.
	Rectangle button. Places a rectangle on the workspace.
	Line button. Places a line on the workspace.
	Circle button. Places a circle on the workspace. Click to place the center of the circle, then move the cursor on the workspace. As you move the cursor, a dotted outline of the circle appears. When the circle is the desired shape and size, click to place it on the workspace.
	Ellipse button. Places an ellipse on the workspace. Click to place the center of the ellipse, then move the cursor on the workspace. As you move the cursor, a dotted outline of the ellipse appears. When the ellipse is the desired shape and size, click to place it on the workspace.
	Multiline button. Places a multiline on the workspace.
	Polygon button. Places a polygon on the workspace.
	Half Ellipse Arc button. Places a half ellipse arc on the workspace.
	Segment Arc button. Places an arc on the workspace. Click once to place the center point of the arc, click again to place the out diameter point. As you move the cursor, a dotted outline of the arc appears. Now move the cursor and click to place the arc's end point.



Button	Description
	Places a bezier curve on the workspace. Click to place the start of the curve, then move the cursor on the workspace. As you move the cursor, a dotted outline of the bezier curve appears. Click to place the end point of the bezier, then move and click the cursor twice more to form the final shape of the bezier.
	Text button. Displays the Enter Text dialog box, where you enter and format text to be placed on the workspace. For details, see “8.5.2.3 Enter Text Dialog Box” on page 8-26.
	Bitmap button. Places a bitmap image on the workspace. Click to display a standard Windows “Open” dialog box, where you can select the desired bitmap.
	Check Symbol button. Confirms that the symbol has no errors, such as duplicate pin names.

## Place Pin Toolbar



The buttons on the Place Pin Toolbar are described below.

Button	Description
	Line Pin button. Places a line pin on the workspace.
	Dot Pin button. Places a dot pin on the workspace.
	Clock Pin button. Places a clock pin on the workspace.
	Dot-Clock Pin button. Places a dot-clock pin on the workspace.
	Input Wedge Pin button. Places an input wedge pin on the workspace.





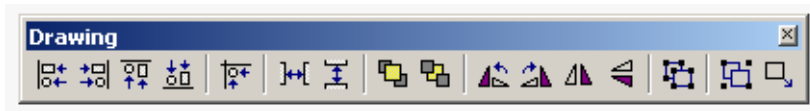

Button	Description
	Output Wedge Pin button. Places an output wedge pin on the workspace.
	Zero-Length Pin button. Places a zero-length pin on the workspace.









**Note** For details on pin types, see “ Pins” on page 8-22.

## Drawing Toolbar



The buttons on the **Drawing** toolbar are described below:

Button	Description
	Align Left button. Moves selected objects horizontally so that their left sides line up with the left side of the left-most object. At least two objects must be selected to enable this button. Does not work for pins.
	Align Right button. Moves selected objects horizontally so that their right sides line up with the right side of the right-most object. At least two objects must be selected to enable this button. Does not work for pins.
	Align Top button. Moves selected objects vertically so that their top sides line up with the top side of the top-most object. At least two objects must be selected to enable this button. Does not work for pins.
	Align Bottom button. Moves the selected objects vertically so that their bottom sides line up with the bottom side of the bottom-most object. At least two objects must be selected to enable this button. Does not work for pins.
	Snap To Grid button. Snaps the selected element(s) to the Draw Grid that is found within the symbol's boundary box. Does not work for pins.
	Distribute Horizontal button. Evenly spaces the selected objects horizontally. At least three objects must be selected to enable this button. Does not work for pins.
	Distribute Vertical button. Evenly spaces the selected objects vertically. At least three objects must be selected to enable this button. Does not work for pins.

Button	Description
	Bring To Front button. Brings selected element(s) to the foreground on the workspace. Other element(s) appear behind them. Does not work for pins.
	Send To Back button. Sends selected element(s) to the background on the workspace. Other elements appear in front of them. Does not work for pins.
	Rotate 90 Counter CW button. Rotates the selected element(s) 90 degrees counter-clockwise. Does not work for pins.
	Rotate 90 Clockwise button. Rotates the selected element(s) 90 degrees clockwise. Does not work for pins.
	Flip Horizontal button. Flips the selected element(s) horizontally on the workspace. Does not work for pins.
	Flip Vertical button. Flips the selected element(s) vertically on the workspace. Does not work for pins.
	Ungroup button. Returns an element that was made using the Group command back to its individual elements. Does not work for pins.
	Group button. Places selected elements in one group. Does not work for pins.
	Resize Boundary Box button. Places a cursor at the lower-right side of the boundary box. Drag it to the desired location to resize the boundary box. You cannot make the boundary box smaller than the elements that it contains or smaller than is required for the pins that are attached to it.

## 8.6 Editing a Component's Model

A component that has an effect on the circuit *must* have a model if you wish to simulate that component.

The **Model** tab of the **Component Properties** dialog box offers you a number of options to choose from when assigning a model to your component. You can:

- create a model
- load an existing model for a component
- modify the model information of a component
- copy a model of one component to another

**Note** If you select a component from the **Master Database**, you will not be able to modify its model information.

Displays the list of Models associated with the component

Allows the user to select a model from the existing Multisim database

Allows the user to add or edit a new or existing model in the Multisim database

Allows the user to delete a model or number of models from the model list in the Model name section

Allows the user to copy model information to other sections of a multisection component

Displays the spice model data of the selected component

Displays template of pins connected to their respective nodes in the model

Symbol Pins	Model Nodes
1A	1
1B	2
1Y	3

The Symbol Pins column displays the names of the pins associated with the symbol.

The Model Nodes column displays the order in which the Symbol Pins are represented in the model data.

You can directly modify the existing model data by using the **Add/Edit** button, or you can enter information from scratch using this method. The **Model Data** and the **Pin Mapping Table** fields contain the information that make up the model itself (and are thus the most important part for simulation purposes). The **Model Data** field contains the model's code (for example in SPICE) and the **Pin Mapping Table** lists the symbol pins and their corresponding mapping order (**Model Nodes**).

**Note** If you modify a model, the model changes for all other components within the same database, whose model is based on that template. If you want to modify a model for a specific component, save the modified model with a name similar to that of the component. Alternatively, you can copy a model whose model template matches what you want.



. You can import or load an existing model. These options are described in more detail in "8.6.3 Loading an Existing Model" on page 8-48.



Depending on your edition of Multisim, you can create your own model using the **Model Makers**. Procedures for using the **Model Makers** are given in “8.11 Creating a Component Model Using the Model Makers” on page 8-64.

**Note** If you choose to edit a model’s data or template directly, be very careful when entering information. Making a typing error or removing a character by mistake could cause the model to function improperly. Unless you are experienced at creating/editing models, it is recommended that you copy a model that has the same Template information you require.

### 8.6.1 Adding a Model to a Component

Multisim allows you to create models and place them in either the **Corporate Database** or **User Database**. These models can then be used when creating components or editing a component’s model.

- To create a model and save it to the **User Database** or **Corporate Database**:  
First add a new model ID to the Database.



1. Click the **Add/Edit** button on the **Model** tab of the **Component Properties** dialog box. The **Select a Model** dialog box appears.

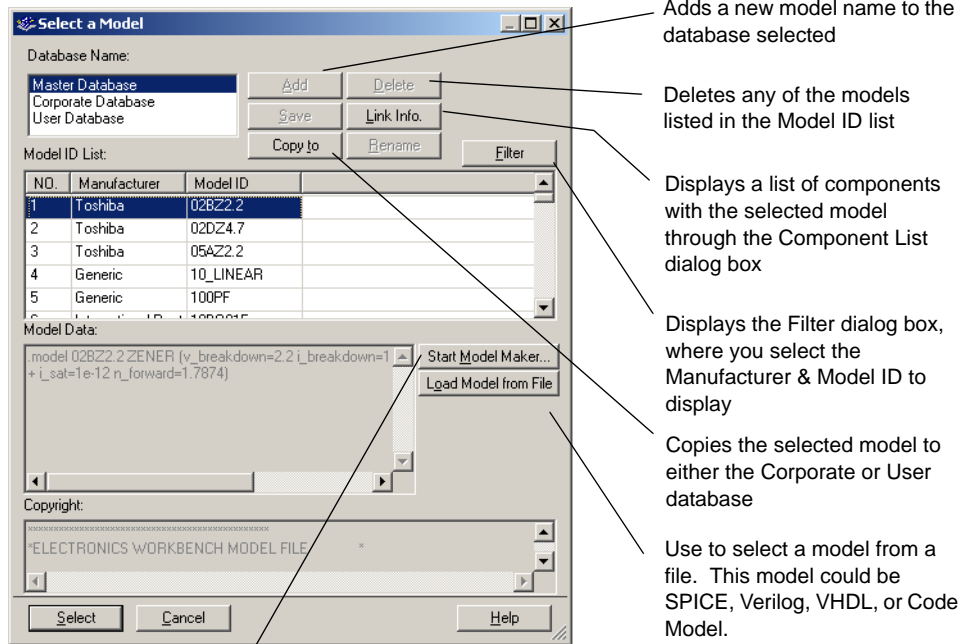

Accesses Multisim's Model Maker in order to create a SPICE model for the selected model.

2. Select the database in the **Database Name** field where you want the new model to be stored.
3. Click the **Add** button. The **Set Parameters** dialog box appears. Enter the name that you would like to call the new model and click **OK**.
4. The name of the model appears in the **Model ID List** of the database you selected.
5. Highlight the model you just created in the **Model ID List**. Notice there is no model data provided.

Next, enter information into the model; you can create a model by writing a SPICE model or using the available **Model Makers**, load a model from a file, or copy existing model data information right into the **Model Data** field.



The models for a component can come from a variety of sources. Please note that some of these options may not be available in your edition of Multisim.

### 8.6.1.1 Component List Dialog Box

- To display a list of components with a selected model:
  1. Select a model in the **Model ID** list in the **Select a Model** dialog box.
  2. Click **Link Info** in the **Select a Model** dialog box. The **Component List** dialog box displays.

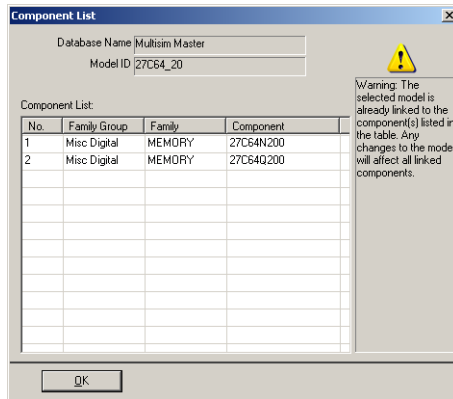

3. Click **OK** to close the dialog.

## 8.6.2 Creating a SPICE Model for a Component

Multisim is based on industry standard SPICE 3F5. It supports models created using standard SPICE syntax. You can create a model using the Model Makers, by assigning values to the parameters of a primitive model, or by creating a subcircuit model.

### 8.6.2.1 Creating a Model Using a Model Maker

- To use a model created by the **Model Makers**:
  1. Select the **Model ID** in the **Select a Model** dialog box.

- Click the **Start Model Maker** button. The **Select Model Maker** dialog box appears.

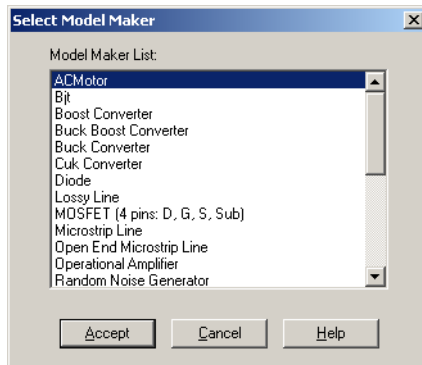

- Select the **Model Maker** you wish to use to make a model.
- Click **Accept** to continue to start the process of making a model. Click **Cancel** to return to the **Model** tab of the **Component Properties** dialog box.
- For analog model makers, refer to subsequent sections of this chapter for procedures on using specific **Model Makers**. For RF model makers, see “15.5 RF Model Makers” on page 15-31.
- When you have entered in all the required information in the **Model Maker** dialog boxes, click **OK**. The data for the model you have just created will appear in the **Model Data** field.

### 8.6.2.2 Creating a Primitive Model

Certain devices have primitive SPICE models. These devices are listed in the table below. A primitive model is a model that is defined by a collection of parameters. They are used as basic building blocks in circuits and in subcircuits.

R	Semiconductor resistor model
C	Semiconductor capacitor model
SW	Voltage controlled switch
CSW	Current controlled switch
URC	Uniform distributed RC model
LTRA	Lossy transmission line model
D	Diode model

NPN	NPN BJT model
PNP	PNP BJT model
NJF	N-channel JFET model
PJF	P-channel JFET model
NMOS	N-channel MOSFET model
PMOS	P-channel MOSFET model
NMF	N-channel MESFET model
PMF	P-channel MESFET model

An example of a primitive model for a 2n2222a NPN BJT Transistor follows. The first line of a primitive model begins with the statement, `.MODEL`, followed by the model name and then the primitive type. In the example below the model name is “2N2222A” and the primitive type is “NPN”. The rest of the lines of the model define the parameters of the NPN BJT. Note that they begin with a “+”. Details regarding the parameters are found in the *Multisim Component Reference Guide*. You do not need to define all of the parameters; any that are omitted are assigned default values.

```
.MODEL 2N2222A NPN
+IS=2.04566e-13 BF=296.463 NF=1.09697 VAF=10
+IKF=0.0772534 ISE=1.45081e-13 NE=1.39296 BR=0.481975
+NR=1.16782 VAR=100 IKR=0.100004 ISC=1.00231e-13
+NC=1.98587 RB=3.99688 IRB=0.2 RBM=3.99688
+RE=0.0857267 RC=0.428633 XTB=0.1 XTI=1
+EG=1.05 CJE=1.09913e-11 VJE=0.99 MJE=0.23
+TF=2.96787e-10 XTF=9.22776 VTF=25.2257 ITF=0.0793144
+CJC=3.1941e-11 VJC=0.4 MJC=0.85 XCJC=0.901093
+FC=0.1 CJS=0 VJS=0.75 MJS=0.5
+TR=3.83883e-07 PTF=0 KF=0 AF=1
```

For further information regarding primitive models, please consult the *Multisim Component Reference Guide* or the SPICE 3F5 user manual (<http://bwrc.eecs.berkeley.edu/Classes/IcBook/SPICE/>).

### 8.6.2.3 Creating a Subcircuit Model

Many electronics devices are not represented by primitives, but are still well suited as SPICE models. Subcircuit Models are used to capture the characteristics of these models. A subcircuit model is built from a collection of devices that contain primitive models, voltage and/or current sources, and/or other subcircuit models.

You can either create a subcircuit model from scratch by typing it into the model data window or you can first draw the circuit in Multisim and export the SPICE netlist and then modify it for use as a subcircuit model.

All subcircuit models must begin with a line that begins with `.SUBCKT` followed by the subcircuit model name and the external nodes of the subcircuit that will be connected to other components. The subcircuit must end with the statement `.ENDS`.

```
.SUBCKT <SubcircuitName> <N1> <N2> <N3> <N4>
...
.ENDS SubcircuitName
```

A subcircuit model is defined by naming and connecting the internal devices that make up the subcircuit. For example, to define that a  $100\text{k}\Omega$  resistor with the reference designator R1 is connected between nodes 4 and 5 you would write:

```
R1 4 5 100k
```

An example of a subcircuit model follows:

```
.SUBCKT SampleSubcircuit 4 2

R1 1 2 1.000e+003
C1 2 0 1.0E-6
R2 1 0 3.0k
D1 0 2 D1N3909

.MODEL D1N3909 D (
+   IS = 6.233e-10
+   RS = 0.003866
+   CJO = 1.132e-10
+   VJ = 0.75
+   TT = 3.699e-07
+   M = 0.2711
```

```
+ BV = 100
+ N = 1.505
+ EG = 1.11
+ XTI = 3
+ KF = 0
+ AF = 1
+ FC = 0.5
+ IBV = 0.0001
+ TNOM = 27
+ )
.ENDS
```

This is the subcircuit for the following circuit drawn in Multisim:

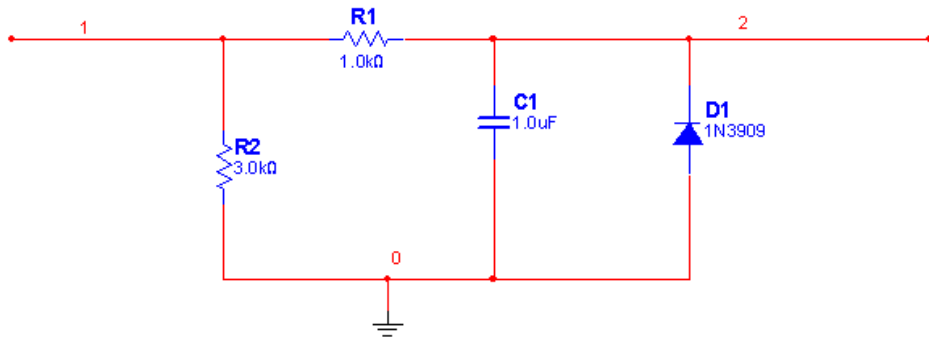

Note that nodes 1 and 2 are the two nodes that will be connected outside of the subcircuit model. They are defined as external nodes by including them in the first line of the subcircuit model.

The resistors, capacitor, and diode are all primitives. The only parameters defined for the resistors and capacitor are their values, but the diode has additional parameters defined using the .model statement.

For more information about creating models from Subcircuits consult the SPICE User Manual.

### Extensions to SPICE 3F5

Multisim is based on industry standard SPICE 3F5; it also supports certain extensions to the language in order to make it more powerful.

You can use conditional statements and tables in the Voltage Controlled Voltage Source, Voltage Controlled Current Source, Current Controlled Voltage Source, and Current

Controlled Current Source. These sources begin with E, G, H, F respectively when used in a subcircuit.

To represent conditional statements you would use the following syntax:

```
<source type><name> <positive node> <negative node> VALUE = { <expression> }
```

Instead of a fixed expression, the value across the nodes can be the result of a conditional expression. The conditional expression should be represented with the following syntax:

```
IF ( <condition>, <value if true>, <value if false>)
```

For example a Voltage Controlled Current source would be defined as:

```
G_example 1 0 Value = { IF ( V(UVLO)>3, 12.5uA, 0 ) }
```

You can also have multiple conditions:

```
IF ( <condition1>, <value if 1 true>, IF ( <condition2>, <value if 2 true>, <value if 2 false>))
```

A Voltage Controlled Current source with multiple conditions would be defined as follows:

```
G_example 1 0 Value = { IF ( V(UVLO)>3, 12.5uA, IF (V(UVLO)>0.5, 5uA, 0) ) }
```

Tables are supported in the following format:

```
E<name> <positive node> <negative node> TABLE { <expression> } =  
+(<input value1>,<output value1> ) ( <input value2>,<output value2> ) ...  
+( <input valuen>,<output valuen> )
```

For example:

```
E_example 11 12 TABLE {V(1) * 0.5 } = (1, 11) (2, 40) (3, 33) (4, 44) (5, 55)  
+ (6, 66) (7, 77.3) (8, 88.1) (9, 99.2)
```

You may also represent non-linear dependant sources as follows:

```
B<name> <positive node> <negative node> <V or I>= <condition> ? <value if true>  
: <value if false>
```

Where V is used for a non-linear dependant voltage source and I is used for a non-linear dependant current source.

For Example:

```
B1 56 0 V=V(20)<1 ? 2 : 0
```

You can also have multiple conditional statements. For example:

```
B1 56 0 V=V(20)<1 ? 2 : V(12)>(4.15+V(6)) ? 0 : 4
```

### 8.6.3 Loading an Existing Model

- To load or import an existing VHDL, Verilog HDL, Code Model, or SPICE model for your component:
  1. Click **Load Model From File** in the **Select a Model** dialog box. A standard file browser appears, allowing you to choose the file type, name and location of the files to be loaded. Before loading a netlist, make sure you know what folder it is in. Most Bspice, Xspice and Pspice netlists end in extensions `.cir` or `.net`.
  2. Select the file to load and click **OK**. The model data appears in the **Model** tab fields of the **Component Properties** dialog box.

**Note** PSpice is not an industry standard, but is proprietary to the Orcad SPICE simulation tool. Since some component vendors make models for their components available in PSpice format, Multisim has been designed to support PSpice models as extensively as possible. However, you will not be able to share models or circuits with other SPICE users or tools.

### 8.6.4 Modify a Model's Data

Models can only be modified if they are in the Corporate or User database. Multisim does not allow information stored in the **Master Database** to be edited.

- To modify a model in the Corporate or User database:
  1. Make sure that the model is located in the Corporate or User database.
  2. Select the model you wish to edit by clicking on it in the **Model ID List** in the **Select a Model** dialog box.
  3. The model data can be modified by making changes directly in the **Model Data** area of the **Select a Model** dialog box.
  4. Select the **Save** button to save any changes that were made to the model.

**Note** If the model that has been modified is being used by a component in the database where it is located (Corporate or User) a message window will appear indicating that the model has been linked to a component in the component database. Multisim will not allow you to save the modifications to this named model. You will have to change the name of the model.



## 8.6.5 Copying the Model of One Component to Another

- To copy the model information from an existing component:
  1. Click **Add From Comp** in the **Model** tab of the **Component Properties** dialog box. The **Select Model Data** dialog box appears.

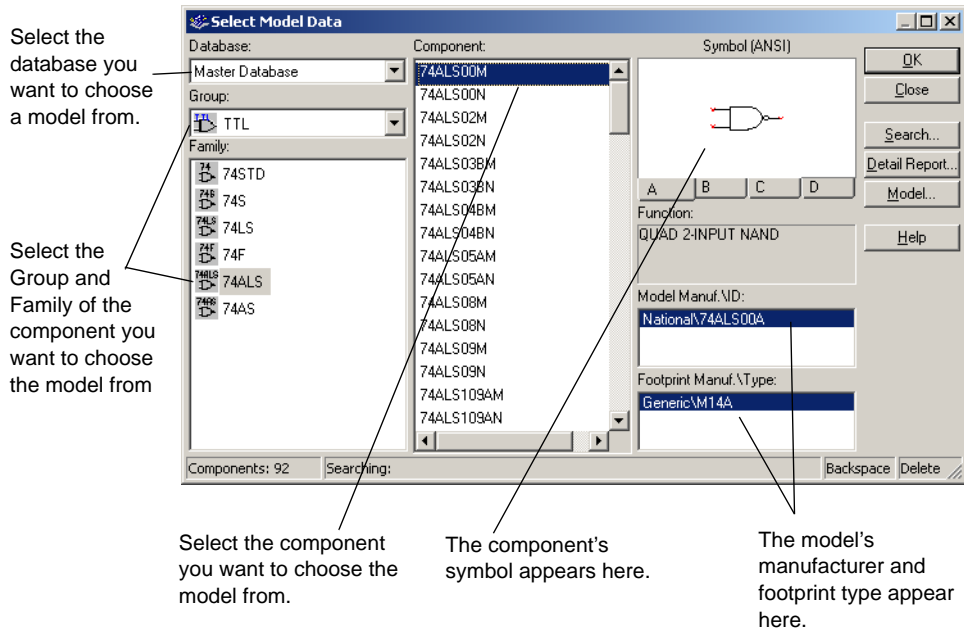

2. Select from among the available databases in the **Database** drop-down list.
3. Using the **Component** list, choose the component whose model template most closely matches what you want.
4. To view the model of the component you selected, click the **Model** button.
5. Click **OK** to return to the **Component Properties** dialog box.
6. The model name is added to the list of models associated to the component.

## 8.7 Editing a Component Pin Model

The **Pin Parameters** tab of the **Component Properties** dialog box allows you to the type of pin for each of the symbol pins in a component.

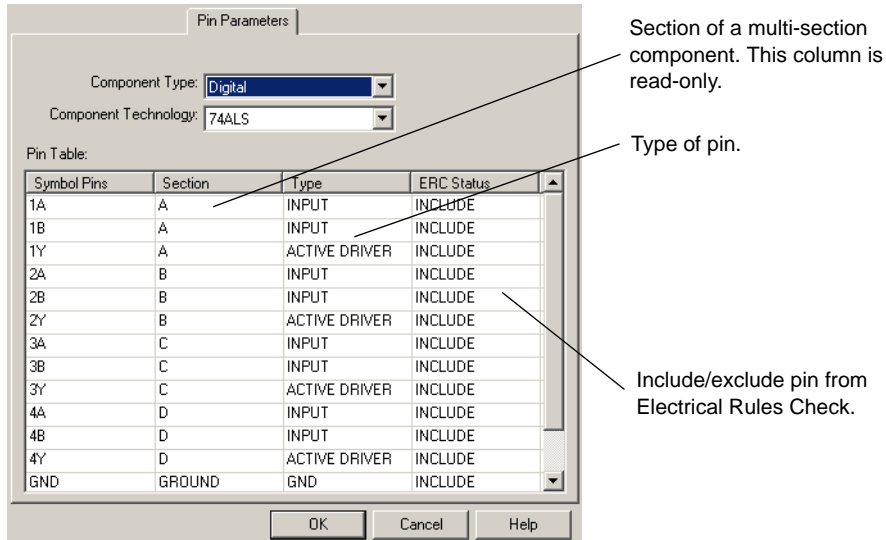

**Note** The Symbol Pin is the name of the pin. For example, most digital parts have pins named “Vcc” and “GND”.

➤ To enter pin parameters:

1. Select the type of component in the **Component Type** drop-down list.
2. Select the technology in the **Component Technology** drop-down list.
3. For each symbol pin, click in the corresponding field in the **Type** column and select the pin type from the drop-down list that appears.

**Tip** You can assign the same pin type to multiple symbol pins at once. Use the CTRL and SHIFT keys to select the desired pins and then select the desired type from one of the *selected* **Type** fields. The type for all of the selected symbol pins will change to reflect your selection.

4. Select whether or not you wish to include each symbol pin in the **Electrical Rules Check** by clicking in the corresponding field in the **ERC Status** column and selecting either INCLUDE or EXCLUDE. (The default is INCLUDE).

## 8.8 Editing a Component's Footprint

The **Footprint** tab of the **Component Properties** dialog box allows you to specify/modify package information for a component and map footprint and symbol pins of a component.

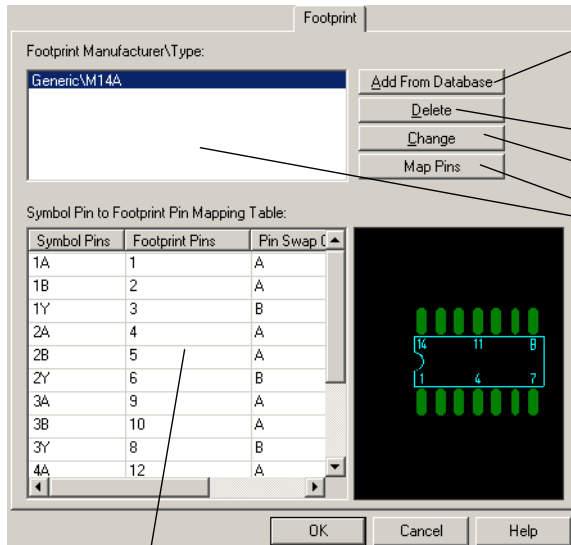

Allows the user to add a footprint package to the component from a list of footprints in the selected database.

Allows the user to delete any of the footprint packages assigned to the component in the Footprint Manufacturer\Type section.

Displays the Change Footprint dialog box (see "5.1.2.3 Edit Footprint Dialog Box" on page 5-6).

Displays the Advanced Pin Mapping dialog box.

Shows the user the manufacturer and footprint name associated with the component.

Shows the symbol pin names of the component and the footprint pin they are associated with in the package.

**Note** A footprint in the **Master Database** cannot be modified. To modify a footprint a copy must be added to the **Corporate Database** or **User Database**.

## 8.8.1 Select a Footprint dialog box

- To modify or enter package information:

1. Click the **Add From Database** button in the **Footprint** tab of the **Component Properties** dialog box. The **Select a Footprint** dialog box appears.

Indicates what database footprints are in.

Lets you filter the contents of the Data List. See "8.8.1.1 Filter dialog box" on page 8-53.

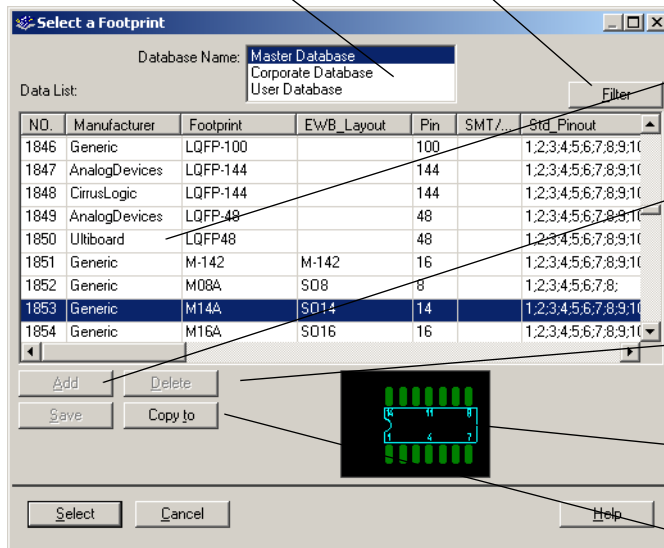

Shows list of footprints.

Lets you add a footprint to the User Database or Corporate Database database. See "8.8.2 Add a Footprint dialog box" on page 8-57

Lets you delete a footprint from the Corporate or User Database.

Shows a snapshot of what the footprint looks like.

Lets you copy a footprint from one database to another.

2. Select the **Database Name** where the footprint is that you want to edit.
3. If the footprint is in the **Master Database**, select the footprint in the **Data List** and click the **Copy To** button. The **Set Parameters** dialog box appears prompting you to place it in the **Corporate Database** or **User Database**.

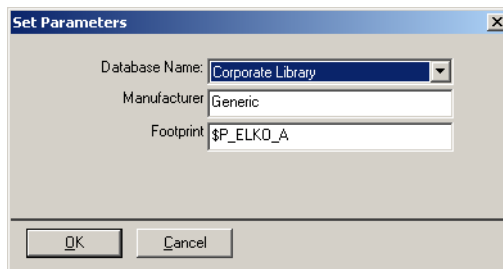

4. Click **OK**. The footprint is copied to the database you indicated and you are returned to the **Select a Footprint** dialog box.
5. Click the field of the footprint you want to modify.
6. Enter the appropriate information.

**Note** Once a footprint is modified, you will be prompted to save the footprint with the modifications. If you choose not to save, the modifications will be removed.

7. Click the **Save** button. The modifications are saved.

➤ To map symbol and footprint pins:

1. Navigate to the **Footprint** tab of the **Component Properties** dialog box.
2. Select the footprint you wish to make modifications to in the **Footprint Manufacturer\Type** box.
3. In the **Symbol Pin to Footprint Pin Mapping Table**, for each **Symbol Pin**:

- Select its corresponding footprint pin from the drop-down list in the **Footprint Pins** column, using information from the component's datasheet.

**Note** For a discussion of the differences between symbol pins and footprint pins, see “Pins” on page 8-22.

- Select its swap group from the drop-down list in the **Swap Group** column. Pins in the same swap group can be interchanged during the PCB layout process.

### 8.8.1.1 Filter dialog box

You can filter what is displayed in the **Data List** of the **Select a Footprint** dialog box by using the **Filter** dialog box. For example, you may wish to view a specific footprint from a specific device manufacturer only.

➤ To filter contents of the **Data List**:

1. Click **Filter** in the **Select a Footprint** dialog box to display the **Filter** dialog box.

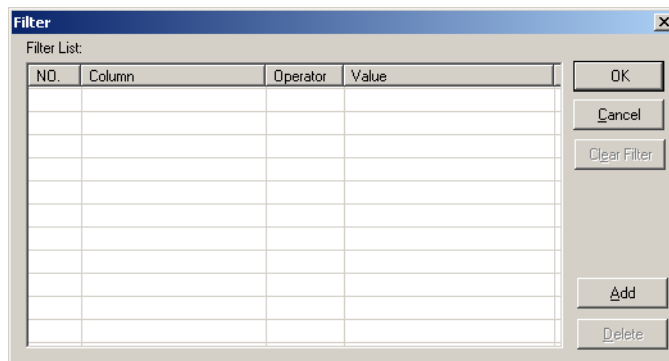

2. Click **Add**. The dialog box changes as shown below.

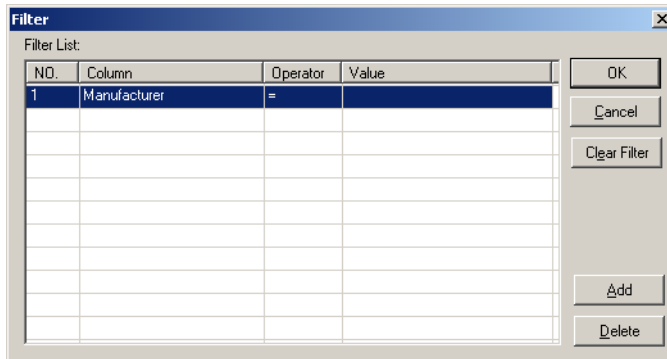

3. Enter desired parameters as shown below:

- **Column** — corresponds to the columns in the **Select a Footprint** dialog box. Click in the field and select the desired value from the drop-down list that appears (“Footprint”, for example).
- **Operator** — select one of: =; NOT =; Contains; Starts with.
- **Value** — a value you would expect to see in the selected **Column** (“16”, for example).

The dialog box will resemble the following:

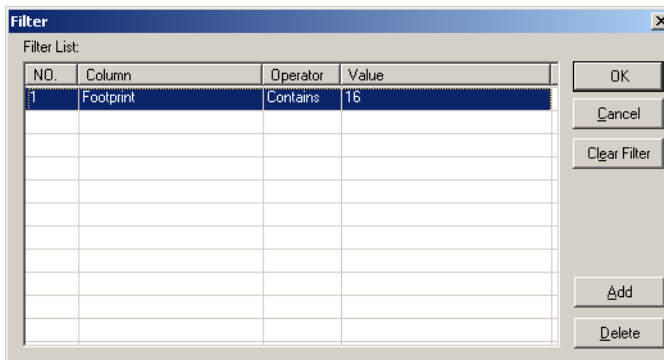

- Click **OK**. The **Filter** dialog box closes and the **Select a Footprint** dialog box displays with the **Data List** populated according to the parameters you entered in the **Filter** dialog box.

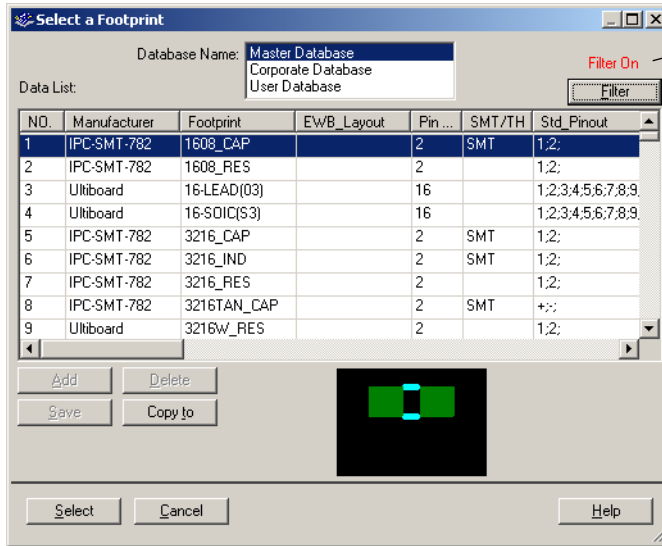

Remains visible until **Clear Filter** is clicked in the **Filter** dialog box.

- Optionally, click **Filter** to display the **Filter** dialog box and enter more parameters.
- Click **Add** and enter parameters as shown above. For example:

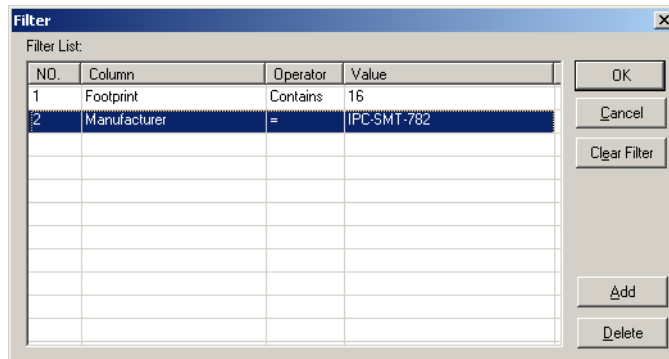

- Click **OK** to return to the **Select a Footprint** dialog box. The contents of the dialog now reflect the two filters that you entered in the **Filter List**.

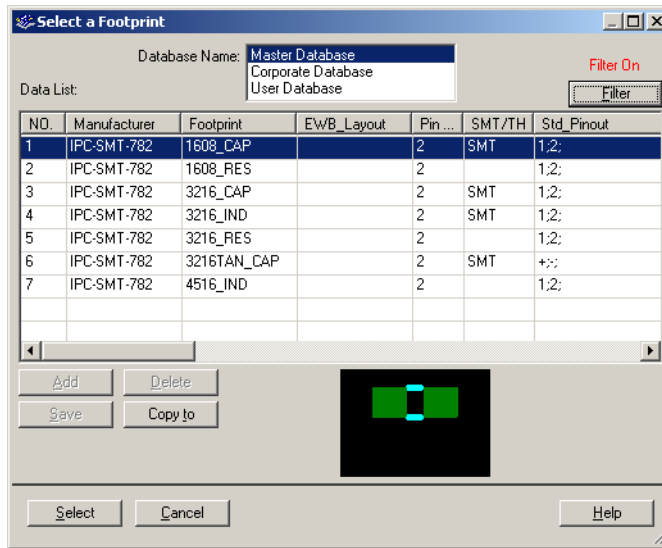

**Tip** Add as many filters as necessary to reduce the items in the **Data List** to an easily scrollable quantity.

- To display all available footprints in the **Select a Footprint** dialog box, click **Clear Filter** and **OK** from the **Filter** dialog box.
- To clear an individual filter from the **Filter** dialog box, select the filter and click **Delete**.



## 8.8.2 Add a Footprint dialog box

- To add a footprint to the **User Database** or **Corporate Database**:
1. Select either **Corporate Database** or **User Database** in the **Database Name** field of the **Select a Footprint** dialog box. For details, see “8.8.1 Select a Footprint dialog box” on page 8-52.
  2. Click on **Add** in the **Select a Footprint** dialog box. The **Add a Footprint** dialog box displays.

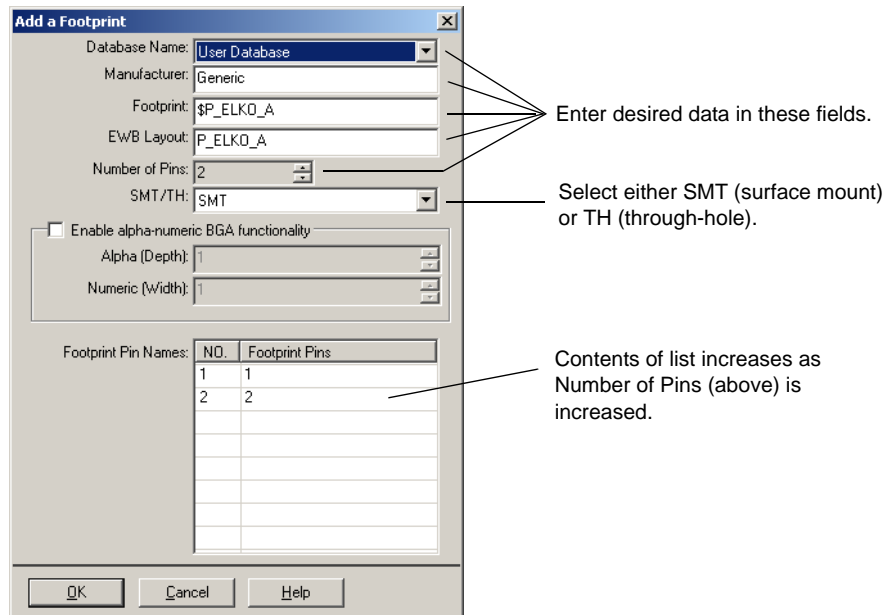

3. Enter the required footprint data as shown above.
4. For BGAs (Ball Grid Arrays):
  - Check the **Enable alpha-numeric BGA functionality** checkbox.
  - **Alpha (Depth)** — enter the number of rows of footprint pins in the BGA.
  - **Numeric (Width)** — enter the number of columns of footprint pins in the BGA.

As you change the values in the above two fields, the **Footprint Pins** values are updated as in the example shown below.

Enable alpha-numeric BGA functionality

Alpha (Depth): 2

Numeric (Width): 4

NO.	Footprint Pins
1	A1
2	A2
3	A3
4	A4
5	B1
6	B2
7	B3
8	B4

**Note** BGA pins in Ultiboard (Electronic Workbench’s PCB layout software), are named in a matrix array starting with A1, A2...Ax; the next row would be B1, B2...Bx, etc. When creating this symbol in Multisim, the footprint pins are initially named 1, 2, 3 etc... . The functionality described in this step allows the footprint pins to be renamed to match the alpha-numeric pin naming method used in Ultiboard. This feature is especially useful for BGAs with large numbers of pins that would otherwise have to be manually renamed.

5. Click **OK**.

### 8.8.3 Advanced Pin Mapping Dialog

The **Advanced Pin Mapping** dialog box is used to map symbol pins to footprint pins and is especially useful for more complex components.

- To display the **Advanced Pin Mapping** dialog box:
  1. Click on the **Map Pins** button in either the **Footprint** tab of the **Component Properties** dialog box, step 5 of the **Component Wizard**, or the **Edit Footprint** dialog box.

This example shows the pin mapping for an LM3301N, Quad High Gain Norton Op-amp.

Shows all pins

Tabs A, B, C & D show pins from individual sections.

The COM tab shows pins common to all sections.

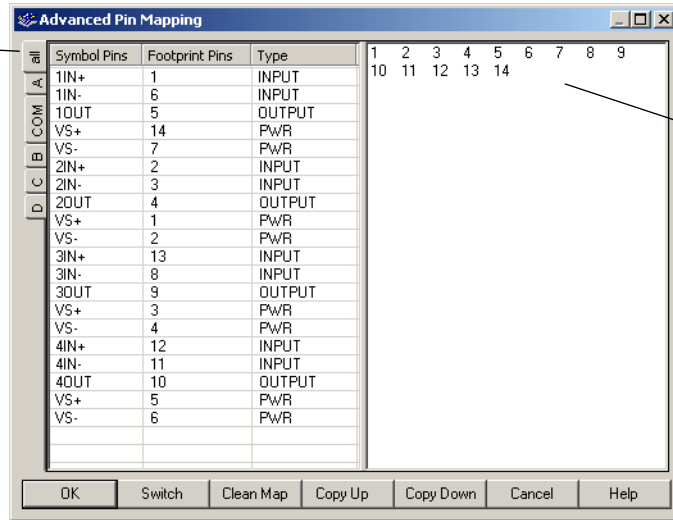

Footprint Pins

- To reverse the display so that the symbol pins appear in the right pane, click **Switch**.

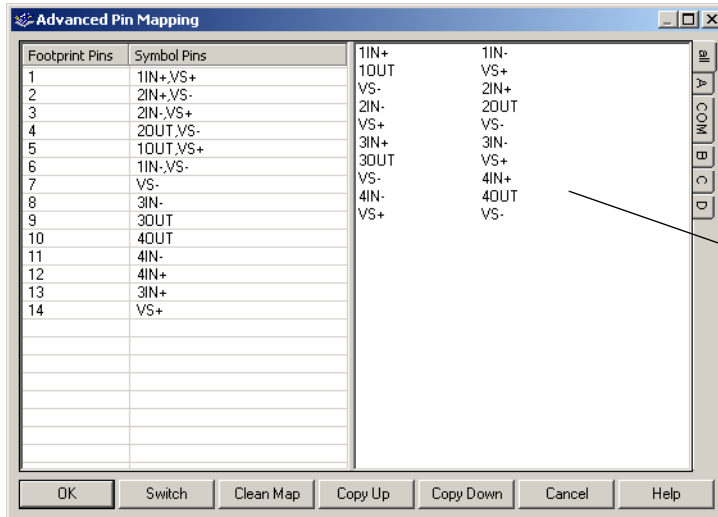

Symbol Pins

- To remove all pin mapping, click **Clean Map**.

## Mapping Pins

The following example uses the **Advanced Pin Mapping** dialog box with the footprint pins displayed in the right pane. If you wish to display the symbol pins in the right pane, click **Switch**. The same mapping techniques will apply.

- To map footprint to symbol pins:

1. Display the **Advanced Pin Mapping** dialog as described earlier in this section.

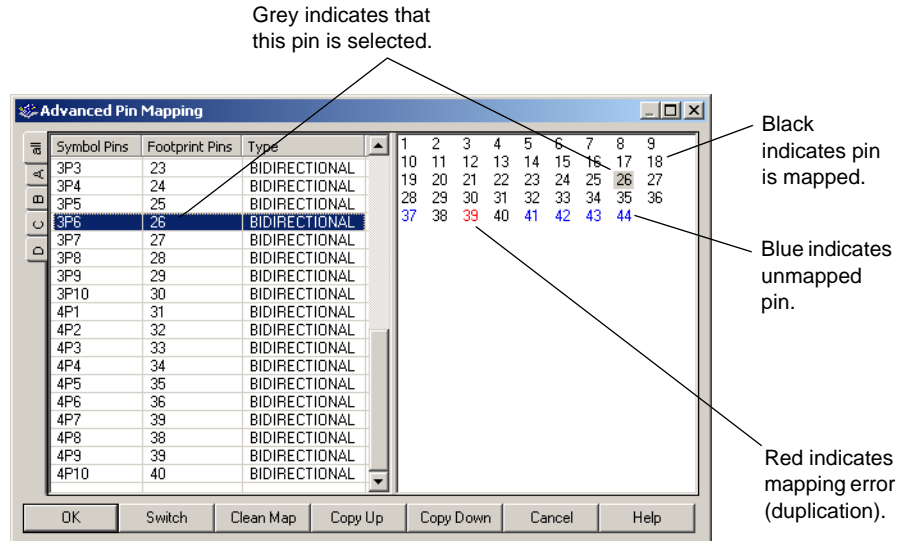

**Tip** Hover the cursor over a pin in the right pane to display a tooltip that shows the pin's mapping.

2. Select a symbol pin in the left column and click on a blue (unmapped) footprint pin in the right pane. The footprint pin's color turns black to indicate that it is mapped.
3. You can also click-and-drag a symbol pin to footprint pin in the right pane to create a mapping (or vice versa).

➤ To use the **Copy Up** and **Copy Down** buttons:

1. Use the SHIFT and/or CTRL keys to select a number of pins:

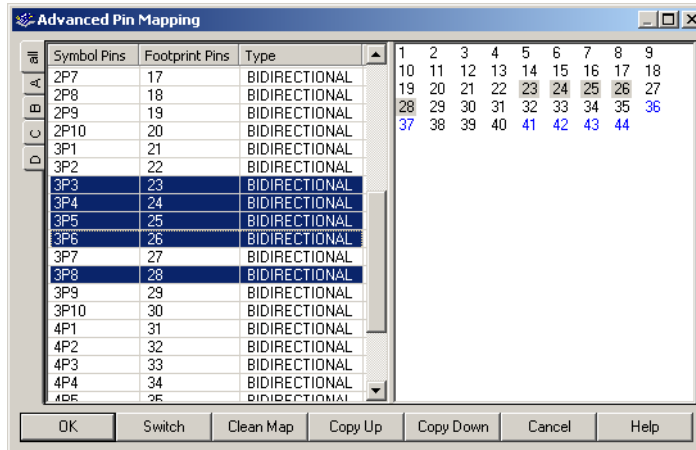

2. Click **Copy Up** to copy the selected pin assignments upwards, as shown below.

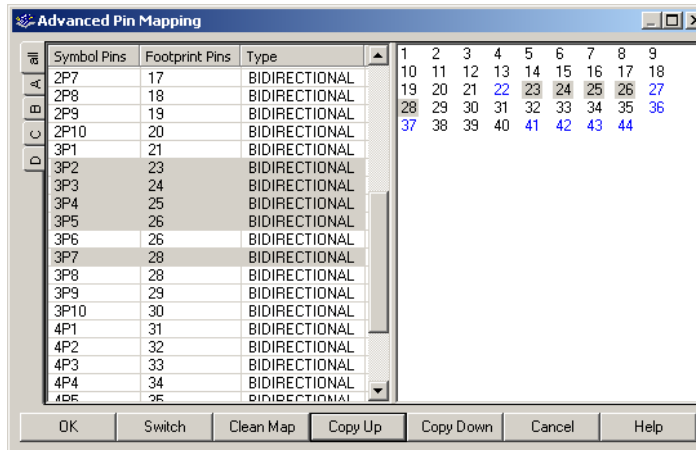

*Or*

Click **Copy Down** to copy the selected pin assignments downward.

## 8.9 Editing a Component's Electronic Parameters

The dialog box consists of two sets of fields. The device parameters vary depending on the type of component.

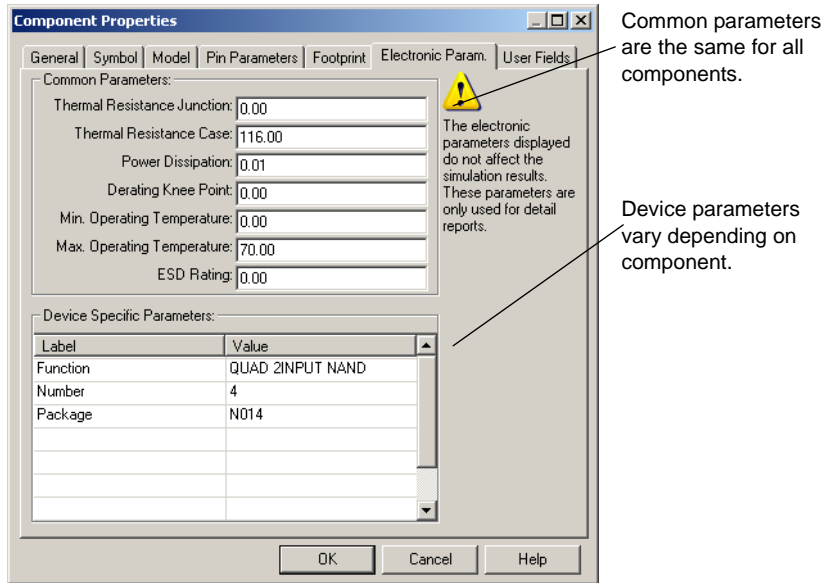

The common parameter fields are common to all components. These are:

Field	Description
Thermal Resistance Junction	Enter or modify the thermal characteristics within the component (from the junction to the case), in watts or degrees centigrade.
Thermal Resistance Case	Enter or modify the thermal characteristics of the whole package (component) in watts or degrees centigrade.
Power Dissipation	Enter or modify the power dissipation of the component, in watts.
Derating Knee Point	Enter or modify the temperature at which the power of the component/package begins to be de-rated, in order to operate the device in its safe operating range. Use degrees centigrade.

Field	Description
Min. Operating Temperature	Enter or modify the lowest ambient temperature at which the component can operate reliably. Use degrees centigrade.
Max. Operating Temperature	Enter or modify the highest ambient temperature at which the component can operate reliably. Use degrees centigrade.
ESD Rating	Enter or modify the electro-static discharge for the component.

## 8.10 Editing User Fields



User fields can be used for any purpose you wish. For example, you might use these fields to record the cost of a component (the price you pay to the supplier or vendor), lead time for ordering, preferred supplier, stock number, and so on. The information is particularly useful in reports and in searching the database for the most appropriate component.

User fields consist of two elements: the field title and the field value. Field titles are shared across databases (that is, all components in all the databases have the same user field titles), and field values are unique to an individual component. Typically, a manager or project leader in your company would populate this level of the database.

**Note** User fields must be given titles before they can be used to record values.

➤ To set up or modify user field titles:

1. Click the **Database Manager** button from the **Standard** toolbar.



*Or*

Choose **Tools/Database/ Database Manager**.

2. Click the **User Field Titles** tab.

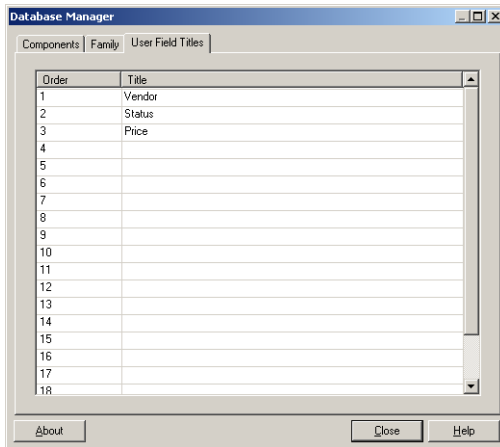

3. Click the appropriate title until a frame appears around it.
4. Enter or change the name for the **Title**. This name will appear in the **Component Properties** dialog box for all components in all databases.

## 8.11 Creating a Component Model Using the Model Makers



Multisim offers advanced **Model Makers** which automatically generate simulation models for you when you give them databook values as input. Using **Model Makers** will save you time and effort but do require experience for you to become proficient with them.

For each **Model Maker**, preset values are provided for a specific model. However, these are not default values, and you can select numerical values based on the component you are interested in, using data from a databook.

When working with databooks, note that different databooks provide parameters for a component model in different styles. While some pieces of information are given numerically in tables or lists for a specific operating point, others are given in the form of a chart or graph. Both types of information are required by Multisim's **Model Makers**. In the case of tables or lists, you will need to enter the operating point and the value that you want. In the case of charts or graphs, the way you select the points from the appropriate curves will have an impact on the accuracy of the parameters of the final model. This guide gives suggestions on methods for selecting points in the procedures for the **Model Makers**. Also, note that the pieces



of information provided by databooks are usually the same from one manufacturer to another, even though the names or labels and descriptions of parameters are different.

**Note** See also, “8.6 Editing a Component’s Model” on page 8-38.

## 8.11.1 AC Motor



1. From the **Model** tab of the **Component Properties** dialog box, click **Add/Edit**. The **Select a Model** dialog box appears.
2. Click **Start Model Maker**. The **Select Model Maker** dialog box appears.
3. From the **Model Maker List**, select **AC Motor** and click **Accept**. (Click **Cancel** to return to the **Model** tab.) The **3 Phase AC Motor** dialog box appears.

Parameter	Value	Unit
Number of Poles (NP)	4	
Rated Voltage (V)	220	V
Stator Inductance (Ls)	146.8	mH
Stator Resistance (Rs)	490	mΩ
Mutual Inductance (M)	131.2	mH
Rotor Inductance (Lr)	146.8	mH
Rotor Resistance (Rr)	2.364	Ω
Rotor Moment of Inertia (Jm)	8.2	m
Rotor Drag (Bm)	1	n
Rotor Friction (Wm)	10	μ

4. Enter desired values in the **3 Phase AC Motor** dialog box.
5. When all values are entered, click **OK** to complete the model, or click **Cancel** to cancel.

## 8.11.2 BJT Model Maker



1. From the **Model** tab of the **Component Properties** dialog box, click **Add/Edit**. The **Select a Model** dialog box appears.
2. Click **Start Model Maker**. The **Select Model Maker** dialog box appears.
3. From the **Model Maker List**, select **BJT** and click **Accept**. (Click **Cancel** to return to the **Model** tab.) The **BJT Model** dialog box appears.
4. Enter values in the **BJT Model** dialog box as described in the following sections.
5. When all values are entered, click **OK** to complete the model, or click **Cancel** to cancel.

**Note** The **BJT Model** dialog box shows preset values for the MPS2222 model.

## Entering General and Table Data

1. In the **BJT Model** dialog box, click the **General** tab:

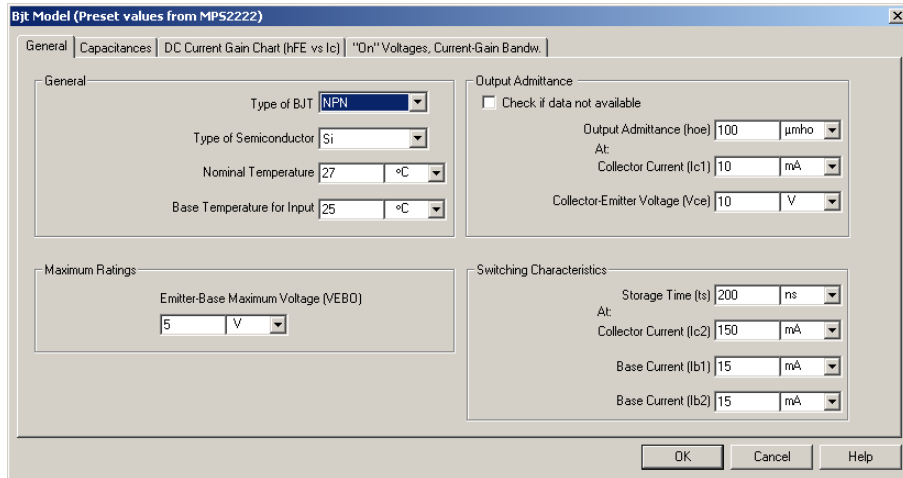

2. Locate data information for the BJT model from a databook.

➤ To enter **General** data:

1. Enter the appropriate BJT type (NPN or PNP) in the **Type of BJT** field. This is usually found on the first page of the data book.
2. In the **Type of Semiconductor** field, enter the type of semiconductor. This is usually found written next to the component type.
3. If desired, change the default value set by Multisim for **Nominal Temperature**.
4. If desired, change the default value for **Base Temperature for Input**. This is typically found in the top left corner of the “Electrical Characteristics” table in the databook.

➤ To enter **Maximum Ratings** data:

1. In the databook for the BJT, locate the “Maximum Ratings” table — for example:

Enter this information in the **Emitter-Base Maximum Voltage** field.

Rating	Symbol	MPS2222	MPS2222A	Unit
Collector–Emitter Voltage	V <sub>CEO</sub>	30	40	Vdc
Collector–Base Voltage	V <sub>CBO</sub>	60	75	Vdc
Emitter–Base Voltage	V <sub>EBO</sub>	5.0	6.0	Vdc
Collector Current — Continuous	I <sub>C</sub>	600		mAdc
Total Device Dissipation @ T <sub>A</sub> = 25°C Derate above 25°C	P <sub>D</sub>	625	5.0	mW mW/°C
Total Device Dissipation @ T <sub>C</sub> = 25°C Derate above 25°C	P <sub>D</sub>	1.5	12	Watts mW/°C
Operating and Storage Junction Temperature Range	T <sub>J</sub> , T <sub>stg</sub>	–55 to +150		°C

2. Find the value for Emitter-Base Voltage and enter the value in the **Emitter-Base Maximum Voltage (VEBO)** field.

➤ To enter **Output Admittance** data:

1. In the databook, locate the “Small Signal Characteristics” table, and find the values for Output Admittance — for example:

Use this information to enter data in the **Output Admittance** fields.

Current–Gain — Bandwidth Product <sup>(2)</sup> (I <sub>C</sub> = 20 mA, V <sub>CE</sub> = 20 Vdc, f = 100 MHz)	MPS2222 MPS2222A	f <sub>T</sub>	250 300	— —	MHz
Output Capacitance (V <sub>CB</sub> = 10 Vdc, I <sub>E</sub> = 0, f = 1.0 MHz)		C <sub>obo</sub>	—	8.0	pF
Input Capacitance (V <sub>EB</sub> = 0.5 Vdc, I <sub>C</sub> = 0, f = 1.0 MHz)	MPS2222 MPS2222A	C <sub>ibo</sub>	— —	30 25	pF
Input Impedance (I <sub>C</sub> = 1.0 mA, V <sub>CE</sub> = 10 Vdc, f = 1.0 kHz) (I <sub>C</sub> = 10 mA, V <sub>CE</sub> = 10 Vdc, f = 1.0 kHz)	MPS2222A MPS2222A	h <sub>ie</sub>	2.0 0.25	8.0 1.25	kΩ
Voltage Feedback Ratio (I <sub>C</sub> = 1.0 mA, V <sub>CE</sub> = 10 Vdc, f = 1.0 kHz) (I <sub>C</sub> = 10 mA, V <sub>CE</sub> = 10 Vdc, f = 1.0 kHz)	MPS2222A MPS2222A	h <sub>re</sub>	— —	8.0 4.0	X 10 <sup>–4</sup>
Small–Signal Current Gain (I <sub>C</sub> = 1.0 mA, V <sub>CE</sub> = 10 Vdc, f = 1.0 kHz) (I <sub>C</sub> = 10 mA, V <sub>CE</sub> = 10 Vdc, f = 1.0 kHz)	MPS2222A MPS2222A	h <sub>fe</sub>	50 75	300 375	—
Output Admittance (I <sub>C</sub> = 1.0 mA, V <sub>CE</sub> = 10 Vdc, f = 1.0 kHz) (I <sub>C</sub> = 10 mA, V <sub>CE</sub> = 10 Vdc, f = 1.0 kHz)	MPS2222A MPS2222A	h <sub>oe</sub>	5.0 25	35 200	μmhos
Collector Base Time Constant (I <sub>E</sub> = 20 mA, V <sub>CB</sub> = 20 Vdc, f = 31.8 MHz)	MPS2222A	rb/C <sub>C</sub>	—	150	ps
Noise Figure (I <sub>C</sub> = 100 μAdc, V <sub>CE</sub> = 10 Vdc, R <sub>S</sub> = 1.0 kΩ, f = 1.0 kHz)	MPS2222A	NF	—	4.0	dB

If data are not available, enable **Check if data not available**.

2. Based on the table data, enter:

- **Output Admittance (hoe)**
- **Collector Current (Ic1)**
- **Collector-Emitter Voltage (Vce)**

**Note** Databooks provide maximum and minimum values for the **Output Admittance** parameter. Select a typical value of output admittance.

➤ To enter **Switching Characteristics** data:

1. In the databook, find the “Switching Characteristics” table — for example:

Use this information to enter data in the **Switching Characteristics** fields.

**SWITCHING CHARACTERISTICS MPS2222A only**

Delay Time	$(V_{CC} = 30 \text{ Vdc}, V_{BE(off)} = -0.5 \text{ Vdc}, I_C = 150 \text{ mAdc}, I_{B1} = 15 \text{ mAdc})$ (Figure 1)	$t_d$	—	10	ns
Rise Time		$t_r$	—	25	ns
Storage Time	$(V_{CC} = 30 \text{ Vdc}, I_C = 150 \text{ mAdc}, I_{B1} = I_{B2} = 15 \text{ mAdc})$ (Figure 2)	$t_s$	—	225	ns
Fall Time		$t_f$	—	60	ns

1. Pulse Test: Pulse Width  $\leq 300 \mu\text{s}$ , Duty Cycle  $\leq 2.0\%$ .
2.  $t_f$  is defined as the frequency at which  $|h_{fe}|$  extrapolates to unity.

2. Based on the table data, enter:

- **Storage Time (ts)**
- **Collector Current (Ic2)**
- **Base Current (Ib1)**
- **Base Current (Ib2)**

## Entering Capacitances Data

1. Click the **Capacitances** tab:

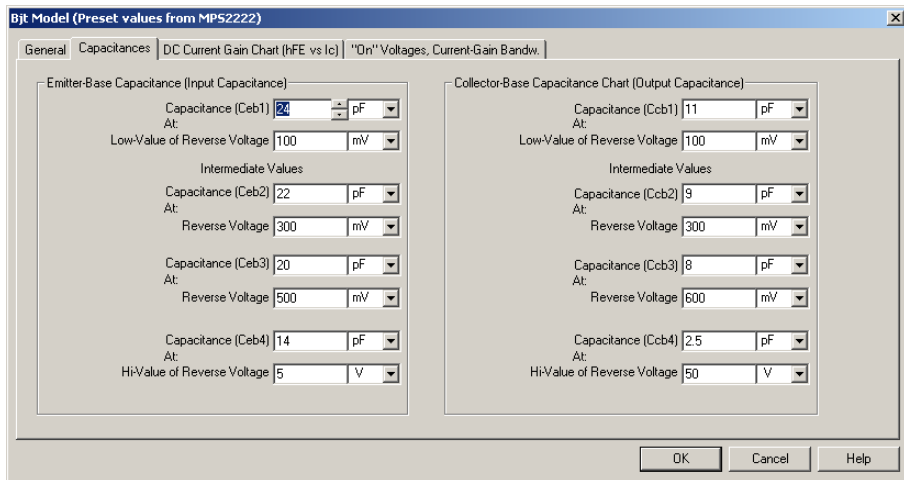

- In the databook, locate the “Ceb and Ccb vs. Reverse Voltages (RV)” graph — for example:

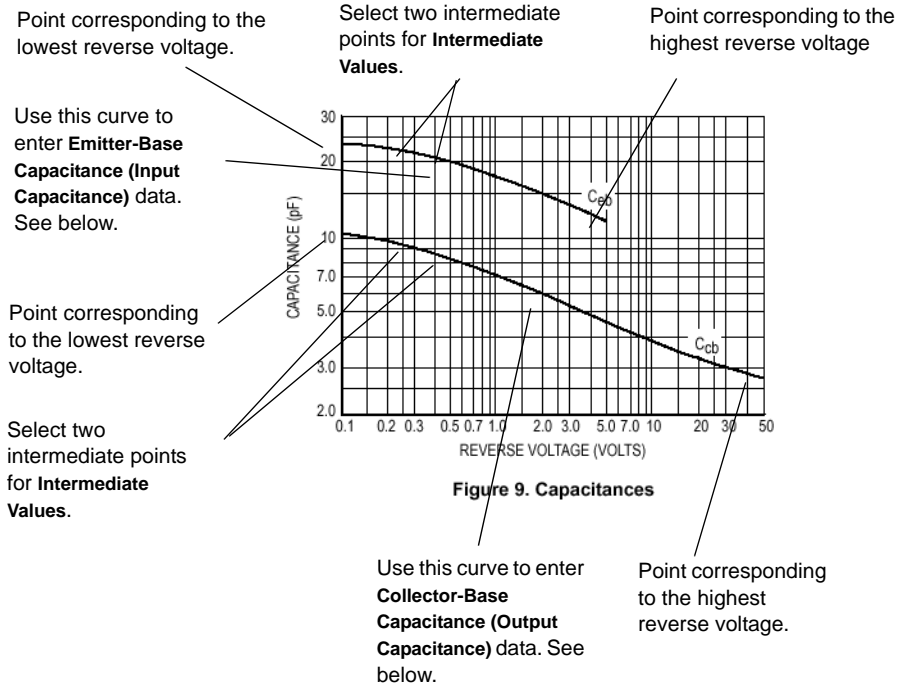

➤ To enter **Emitter-Base Capacitance (Input Capacitance)** data:

- On the  $C_{eb}$  curve, locate the point corresponding to the lowest voltage, or the beginning point, of the  $C_{eb}$  curve. Use the coordinates of this point to enter values for:
  - **Capacitance (Ceb1)**
  - **Low-Value of Reverse Voltage**
- On the same curve, locate the point corresponding to the maximum voltage, or the end point. Use the coordinates of this point to enter values for:
  - **Capacitance (Ceb4)**
  - **Hi-Value of Reverse Voltage**
- To enter **Intermediate Values**, select two intermediate points close to the left side in the low voltage region. Ensure that they are not too close, to avoid excessive error in the model. Use the coordinates of the first and second points to enter values for:
  - **Capacitance (Ceb2) at Reverse Voltage**
  - **Capacitance (Ceb3) at Reverse Voltage**

- To enter **Collector-Base Capacitance Chart (Output Capacitance)** data:
- Using the Ccb curve from the same “Ceb and Ccb vs. Reverse Voltages (RV)” graph, repeat steps 1 through 3 above to enter values for:
    - **Capacitance (Ccb1)**
    - **Low-Value of Reverse Voltage**
    - **Capacitance (Ccb2) at Reverse Voltage**
    - **Capacitance (Ccb3) at Reverse Voltage**
    - **Capacitance (Ccb4)**
    - **Hi-Value of Reverse Voltage**

## Entering DC Current Gain Chart data

- Click the **DC Current Gain Chart (hFE vs. Ic)** tab:

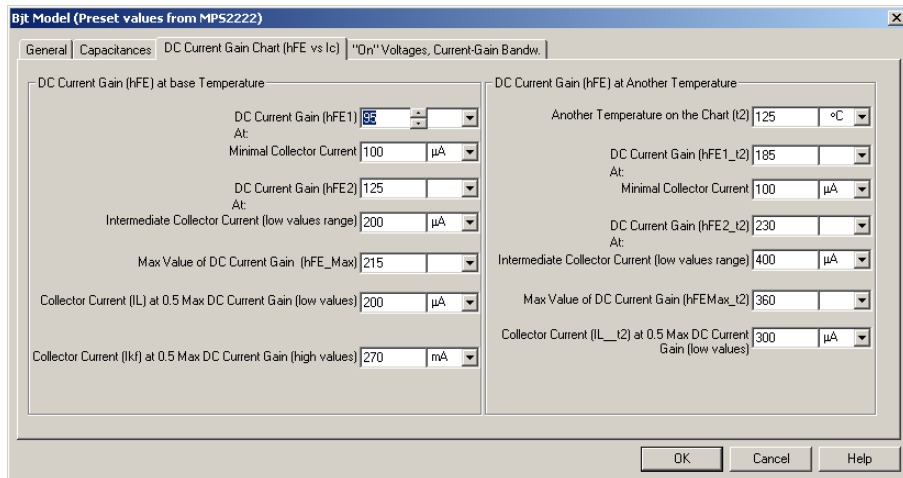

- In the databook for the BJT, locate the  $h_{FE}$  vs.  $I_C$  graph.

➤ To enter **DC Current Gain (hFE) at base Temperature** data:

1. Among the hFE vs.  $I_c$  curves at the base temperature for the BJT, select the one whose  $V_{ce}$  is most likely the operating point for the transistor. For example:

Select a point to represent the intermediate DC Current Gain in the low  $I_c$  region.

Point corresponding to minimal DC Current Gain

$I_c$  value for point corresponding to 0.5 of maximum gain in the low  $I_c$  region (see “Entering “On” Voltages and Current-Gain Bandwidth Data” on page 8-73).

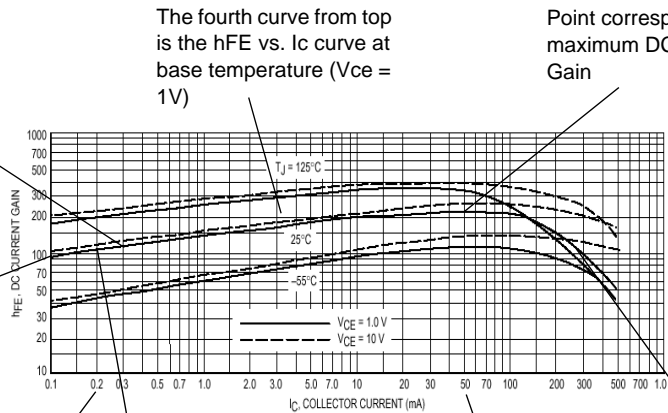

Point corresponding to 0.5 of the maximum DC Current Gain in the low  $I_c$  region

$I_c$  value for point corresponding to maximum gain (see “Entering “On” Voltages and Current-Gain Bandwidth Data” on page 8-73).

Point corresponding to 0.5 of the maximum DC Current Gain in the high  $I_c$  region

Figure 3. DC Current Gain

**Note** You must select a curve with the same voltage as the  $I_c$ - $V_{be}$  curve you will use to enter data on the last tab of this dialog box. See “Entering “On” Voltages and Current-Gain Bandwidth Data” on page 8-73.

2. Find the point on the curve corresponding to the minimal collector current, or the beginning point of the curve. Use the coordinates of this value to enter:
  - **DC Current Gain (hFE1)**
  - **Minimal Collector Current**
3. Select a point from the low  $I_c$  region of the same curve. Use the coordinates of this point to enter:
  - **DC Current Gain (hFE2)**
  - **Intermediate Collector Current (low values range)**
4. Find the highest point on the curve, and enter its DC Current Gain value in the **Max Value of DC Current Gain (hFE\_Max)** field.

**Note** You must note the  $I_c$  value of this point to plot points on the  $I_c$ - $V_{be}$  curve you will use to enter data on the last tab of this dialog box. See “Entering “On” Voltages and Current-Gain Bandwidth Data” on page 8-73.

5. Find the two points corresponding to 0.5 of the maximum DC current gain value, one in the low  $I_c$  region and one in the high  $I_c$  region. Use these points to enter:

- **Collector Current ( $I_L$ ) at 0.5 Max DC Current Gain (low values range)**
- **Collector Current ( $I_{kf}$ ) at 0.5 Max DC Current Gain (high values range)**

**Note** You must note the  $I_c$  value of the point in the low  $I_c$  region to plot points on the  $I_c$ - $V_{be}$  curve you will use to enter data on the last tab of this dialog box. See “Entering “On” Voltages and Current-Gain Bandwidth Data” on page 8-73.

➤ To enter **DC Current Gain (hFE) at another Temperature** data:

1. Using the hFE vs.  $I_c$  graph, find a curve at a different temperature from the base temperature. (This can be any other temperature.) For example:

Point corresponding to 0.5 of the maximum DC Current Gain in the low  $I_c$  region

The second from top curve is hFE vs.  $I_c$  at 125° ( $V_{ce} = 1V$ )

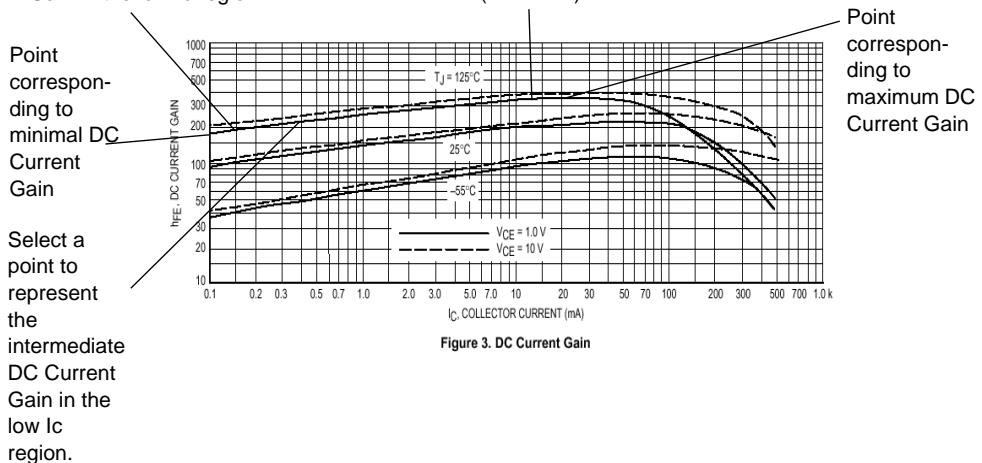

2. Enter the temperature of the selected curve in the **Another temperature on the Chart (t2)** field.

3. Find the point on the curve corresponding to the minimal collector current, or the beginning point of the curve. Use the coordinates of this value to enter:

- **DC Current Gain (hFE1\_t2)**
- **Minimal Collector Current**



4. Select a point from the low  $I_c$  region of the same curve. Use the coordinates of this point to enter:
  - **DC Current Gain (hFE2\_t2)**
  - **Intermediate Collector Current (low values range)**
5. Find the highest point on the curve, and enter its DC Current Gain value in the **Max Value of DC Current Gain (hFE\_Max2)** field.
6. Find a point corresponding to 0.5 of the maximum DC current gain value in the low  $I_c$  region and enter its value in the **Collector Current (IL\_t2) at 0.5 Max DC Current Gain (low values range)** field.

## Entering “On” Voltages and Current-Gain Bandwidth Data

1. Click the “On” Voltages, Current-Gain Bandw. tab:

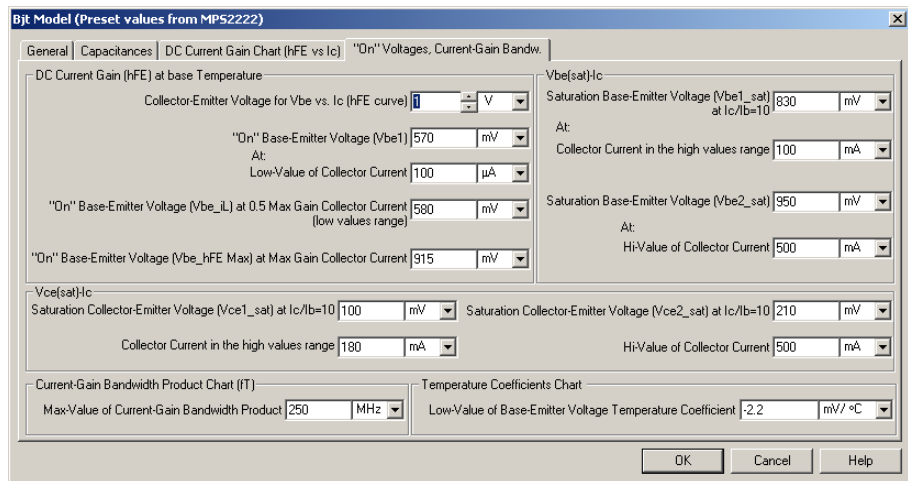

2. In the databook, locate the  $I_c$  vs.  $V_{be}$  graph.

➤ To enter **DC Current Gain (hFE) at Base Temperature** data:

1. On the graph, locate the curve with the same  $V_{ce}$  as the one used in the hFE data. Enter its  $V_{ce}$  value in the **Collector-Emitter Voltage for  $V_{be}$  vs.  $I_c$  (same as hFE curve)** field. For example:

The second from top curve is the  $V_{be}$  vs.  $I_c$  with same  $V_{ce}$  as  $I_c$ -hFE curve. (See “Entering DC Current Gain Chart data” on page 8-70.)

Point corresponding to minimal  $V_{be}$

Point corresponding to 0.5 of the maximum DC Current gain. (See “Entering DC Current Gain Chart data” on page 8-70.)

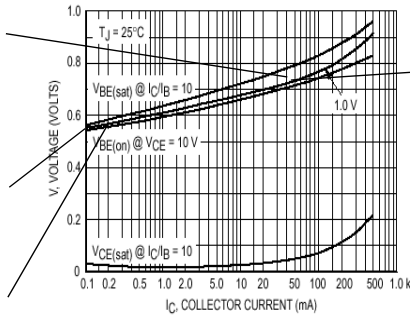

Point corresponding to maximum DC Current gain. (See “Entering DC Current Gain Chart data” on page 8-70.)

Figure 11. “On” Voltages

2. Find the point on this curve corresponding to the minimal  $I_c$  value, or the beginning point of the curve. Use the coordinates of this point to enter:
  - **“On” Base-Emitter Voltage (Vbe1)**
  - **Low-Value of Collector Current**
3. Using the  $I_c$  vs. hFE graph from the previous section, locate the  $I_c$ -hFE curve at the base temperature that was used to enter data on the third tab of this dialog box. At the point of the maximum DC Current Gain (hFE), note the coordinate for the collector current ( $I_c$ ).
4. On the  $I_c$ - $V_{be}$  graph, find the point corresponding to this coordinate for  $I_c$  on the curve used in steps 1 to 3. Enter the voltage for this point in the **“On” Base-Emitter Voltage (Vbe\_hFEMax) at Max Gain** field.
5. Using the  $I_c$  vs. hFE graph from the previous section, locate the  $I_c$ -hFE curve at the base temperature that was used to enter data on the third tab of this dialog box. At the point corresponding to 0.5 of the maximum DC Current Gain (hFE), note the coordinate for the collector current ( $I_c$ ).
6. On the  $I_c$ - $V_{be}$  graph, find the point corresponding to this coordinate for  $I_c$  on the curve used in steps 1 to 4. Enter the voltage for this point in the **“On” Base-Emitter Voltage (Vbe\_iL) at 0.5 Max Gain Collector Current (low values range)** field.

➤ To enter **Vbe(sat)-Ic** data:

- Using the  $I_c$  vs.  $V_{be}$  graph, locate the curve whose  $V_{be}(\text{Sat})@I_c/I_b=10$ . For example:

The top curve is  $V_{be}-I_c$  when  $V_{be}$  is saturated and  $I_c/I_b=10$ .

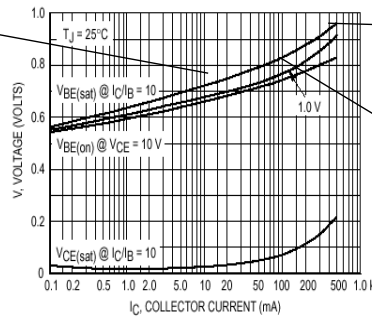

Point corresponding to highest value of collector current

Select a point in the high values range of the collector current.

Figure 11. "On" Voltages

- Find the highest point on the curve. Use the coordinates of this point to enter:
  - **Saturation Base-Emitter Voltage ( $V_{be2\_sat}$ )**
  - **Hi-Value of Collector Current**
- Select a point on the curve in the high values range of the collector current. Use the coordinates of this point to enter:
  - **Saturation Base-Emitter Voltage ( $V_{be1\_sat}$ )**
  - **Collector Current in the high values range**

➤ To enter **Vce(sat)-Ic** data:

- Using the  $I_c$  vs.  $V_{be}$  graph, locate the curve whose  $V_{be}(\text{Sat})@I_c/I_b=10$ . For example:

The bottom curve is  $V_{be}-I_c$  when  $V_{ce}$  is saturated and  $I_c/I_b=10$ .

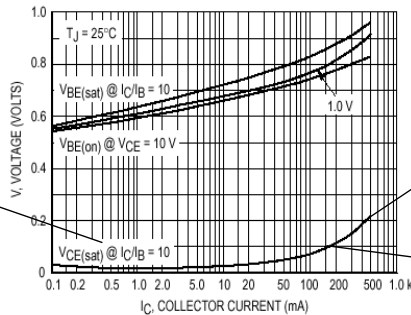

Point corresponding to highest value of collector current

Select a point in the high values range of the collector current.

Figure 11. "On" Voltages

- Find the highest point on the curve. Use the coordinates of this point to enter:
  - **Saturation Collector-Emitter Voltage ( $V_{ce2\_sat}$ )**
  - **Highest Value of Collector Current**

3. Select a point on the curve in the high values range of the collector current. Use the coordinates of this point to enter:

- **Saturation Collector-Emitter Voltage (Vce1\_sat)**
- **Collector Current in the high values range**

➤ To enter **Current-Gain Bandwidth Product Chart (fT)** data:

1. In the databook, locate the “Current-Gain Bandwidth Product versus Frequency” graph — for example:

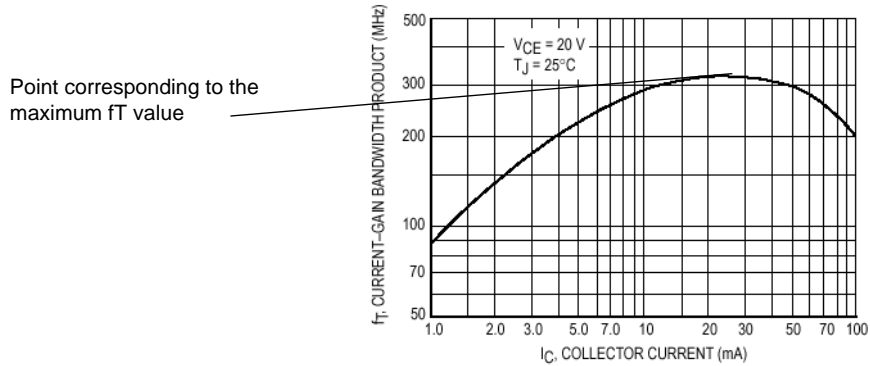

Figure 10. Current-Gain Bandwidth Product

2. Locate the maximum fT value, or the highest point, of the curve. Enter this value in the **Maximum Value of Current-Gain Bandwidth Product** field.

➤ To enter **Temperature Coefficients Chart** data:

1. In the databook, locate the “Temperature Coefficients” chart — for example:

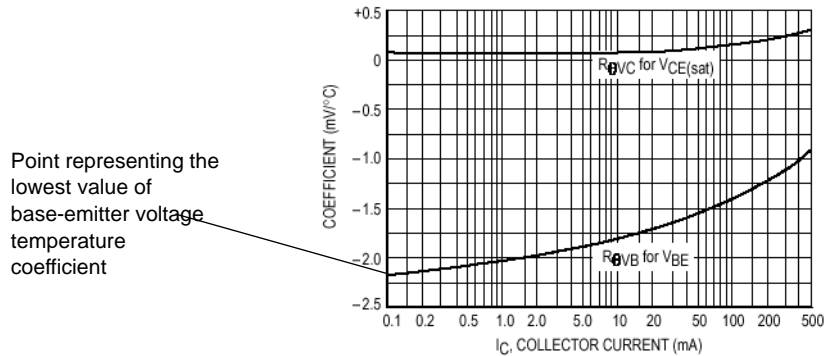

Figure 12. Temperature Coefficients

- On the base-emitter temperature coefficient curve, find the minimum value, or the lowest point, and enter this value in the **Lowest Value of Base-Emitter Voltage Temperature Coefficient** field.

## 8.11.3 Converters

### Buck Converter



A buck converter is a step-down converter that can be represented by the following equivalent circuit:

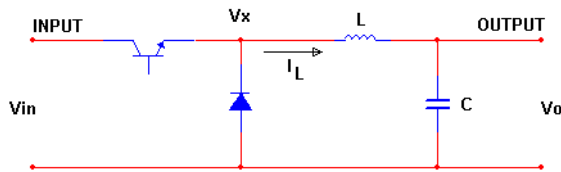

For details on this **Model Maker**, see “8.11.3.3 Buck Converter” on page 8-79.

### Boost Converter

A boost converter is a step-up converter that can be represented by the following equivalent circuit:

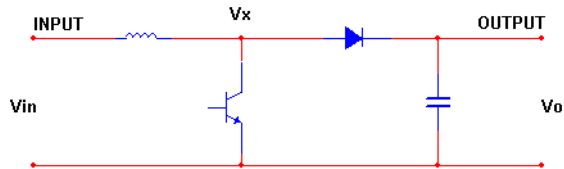

For details on this **Model Maker**, see “8.11.3.1 Boost Converter” on page 8-78.

## Buck-Boost Converter

A buck-boost converter is a step-down—step-up converter that can be represented by the following equivalent circuit:

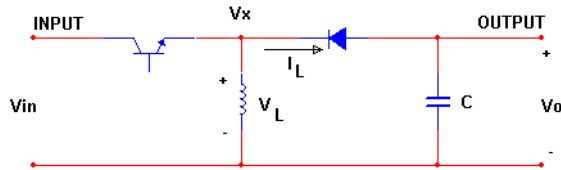

For details on this **Model Maker**, see “8.11.3.2 Buck Boost Converter” on page 8-79.

## Cuk Converter

The cuk converter can be represented by the following equivalent circuit:

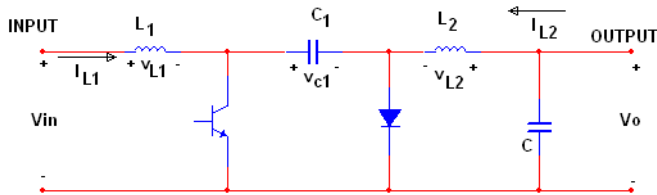

For details on this Model Maker, see “8.11.3.4 Cuk Converter” on page 8-80.

## 8.11.3.1 Boost Converter



1. From the **Model** tab of the **Component Properties** dialog box, click **Add/Edit**. The **Select a Model** dialog box appears.
2. Click **Start Model Maker**. The **Select Model Maker** dialog box appears.
3. From the **Model Maker List**, select **Boost Converter** and click **Accept**. (Click **Cancel** to return to the **Model** tab.) The **Boost Converter Model** dialog box appears.

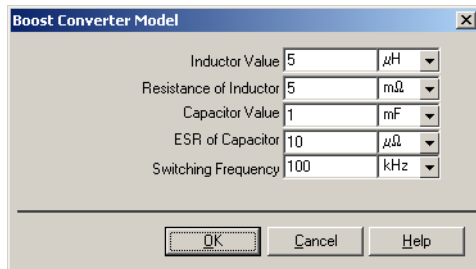

4. Enter desired values in the **Boost Converter Model** dialog box.
5. When all values are entered, click **OK** to complete the model, or click **Cancel** to cancel.

### 8.11.3.2 Buck Boost Converter



1. From the **Model** tab of the **Component Properties** dialog box, click **Add/Edit**. The **Select a Model** dialog box appears.
2. Click **Start Model Maker**. The **Select Model Maker** dialog box appears.
3. From the **Model Maker List**, select **Buck Boost Converter** and click **Accept**. (Click **Cancel** to return to the **Model** tab.) The **Buck Boost Converter Model** dialog box appears.

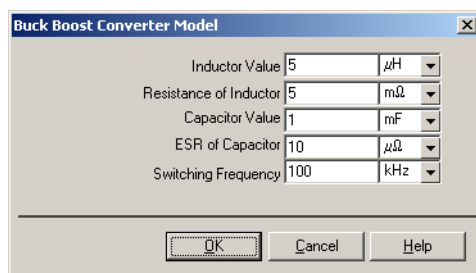

4. Enter desired values in the **Buck Boost Converter Model** dialog box.
5. When all values are entered, click **OK** to complete the model, or click **Cancel** to cancel.

### 8.11.3.3 Buck Converter



1. From the **Model** tab of the **Component Properties** dialog box, click **Add/Edit**. The **Select a Model** dialog box appears.
2. Click **Start Model Maker**. The **Select Model Maker** dialog box appears.
3. From the **Model Maker List**, select **Buck Converter** and click **Accept**. (Click **Cancel** to return to the **Model** tab.) The **Buck Converter Model** dialog box appears.

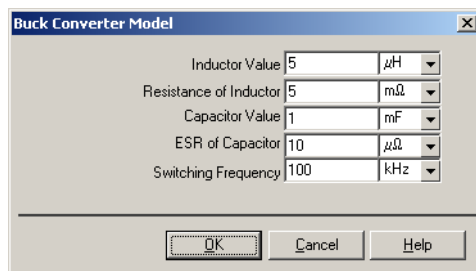

4. Enter desired values in the **Buck Converter Model** dialog box.

- When all values are entered, click **OK** to complete the model, or click **Cancel** to cancel.

### 8.11.3.4 Cuk Converter



- From the **Model** tab of the **Component Properties** dialog box, click **Add/Edit**. The **Select a Model** dialog box appears.
- Click **Start Model Maker**. The **Select Model Maker** dialog box appears.
- From the **Model Maker List**, select **Cuk Converter** and click **Accept**. (Click **Cancel** to return to the **Model** tab.) The **Cuk Converter Model** dialog box appears.

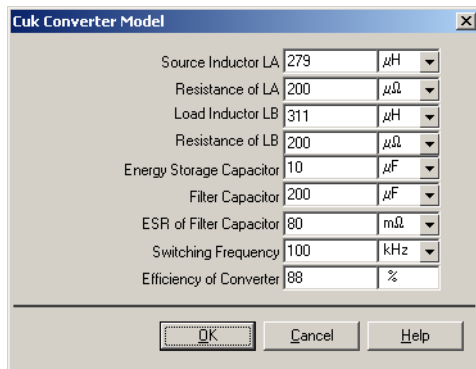

- Enter desired values in the **Cuk Converter Model** dialog box.
- When all values are entered, click **OK** to complete the model, or click **Cancel** to cancel.

### 8.11.4 Diode Model Maker



- From the **Model** tab of the **Component Properties** dialog box, click **Add/Edit**. The **Select a Model** dialog box appears.
- Click **Start Model Maker**. The **Select Model Maker** dialog box appears.
- From the **Model Maker List**, select **Diode** and click **Accept**. (Click **Cancel** to return to the **Model** tab.) The **Diode Model** dialog box appears.
- Enter values in the **Diode Model** dialog box as described in the following sections.
- When all values are entered, click **OK** to complete the model, or click **Cancel** to cancel.

**Note** The **Diode Model** dialog box shows preset values for the IN4001 model.



## Entering General Data

1. Click the **General** tab:

The screenshot shows the 'Diode Model (Preset values from 1N4001)' dialog box with the 'General' tab selected. The 'Junction Capacitance Chart' sub-tab is also visible. The 'Reverse Characteristics' section includes: Maximum repetitive peak reverse voltage (VRRM) set to 50 V, Maximum DC reverse current at VRRM (IR) set to 5 μA, and Typical reverse recovery time (trr) set to 30 μs. The 'Reverse Breakdown' section has a checked box for 'Check if data not available', Reverse Breakdown Voltage (BV) set to 51 V, and Reverse Breakdown Current (IBV) set to 5 mA. The 'Instantaneous Forward Characteristics' section includes: Lowest forward current (IF1) set to 10 mA at a lowest forward voltage (VF1) of 620 mV, Forward current (IF2) set to 1 A at an intermediate forward voltage (VF2) of 300 mV, Highest forward current (IFM) set to 20 A at a highest forward voltage (VFM) of 1.8 V. The dialog has 'OK', 'Cancel', and 'Help' buttons at the bottom.

2. Look up data information for the diode in a databook.

➤ To enter **Reverse Characteristics** data:

1. In the databook, find the “Maximum Ratings and Electrical Characteristics” table.
2. Based on information in this table, enter the following values:
  - **Maximum repetitive peak reverse voltage (VRRM)**
  - **Maximum DC reverse current at VRRM (IR)**
  - **Typical reverse recovery time (trr).**

➤ To enter **Reverse Breakdown** data:

1. In the databook, find the “Reverse Voltage vs. Reverse Current” chart.  
If no data are available, enable **Check if data not available**.
2. On the chart, locate the graph that indicates the ambient temperature of 25° C.
3. Select a point on the graph that represents the mid-point of the horizontal direction, as indicated in the chart.
4. Use the coordinates of this point to enter values for:
  - **Reverse Breakdown Voltage (BV)**
  - **Reverse Breakdown Current (IBV)**

➤ To enter **Instantaneous Forward Characteristics** data:

1. In the databook, locate the “Typical Instantaneous Forward Characteristics” graph — for example:

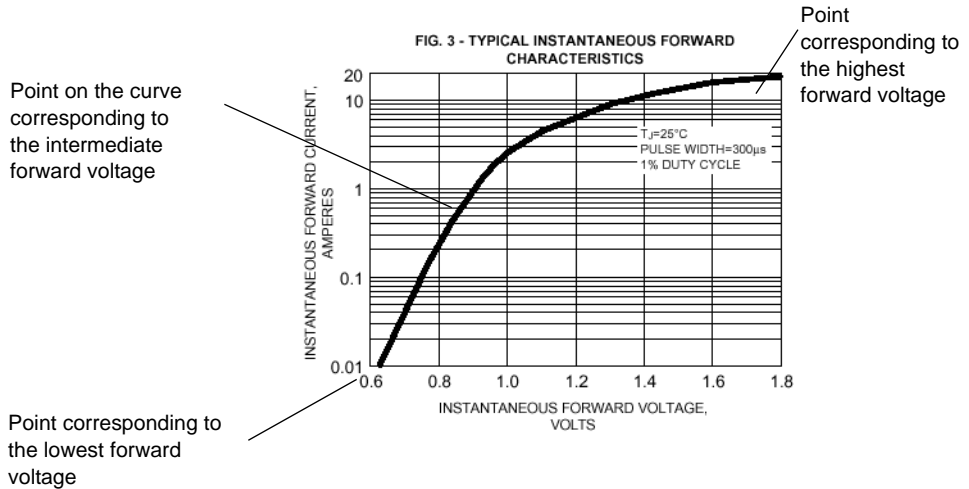

2. Find the point of lowest forward voltage, at beginning point of the curve. Use the coordinates of this point to enter values for:

- **Lowest forward current (IF1)**
- **Lowest forward voltage (VF1)**

3. Find the point of highest forward voltage, or the end point on the curve. Use the coordinates of this point to enter values for:

- **Highest forward current (IFM)**
- **Highest forward voltage (VFM).**

4. Using your eye or a ruler, find the second or intermediate point on the curve which you think best identifies the transition point in the curve.

**Note** Guidelines for selecting the intermediate point vary from one databook to another. If the graph is provided in logarithmic format, which is usually the case, a good way to find this point is to place a ruler along the beginning of the curve in the lower voltage area, which will look like a straight line. Where the curve begins to diverge from your ruler, use this point as your intermediate point. If the graph is provided in linear format, plot the data in logarithmic fashion and follow the ruler procedure.

5. Use the coordinates of this point to enter the values for:

- **Forward current (IF2)**
- **Intermediate forward voltage (VF2).**

## Entering Capacitance data

1. Click the **Junction Capacitance Chart** tab:

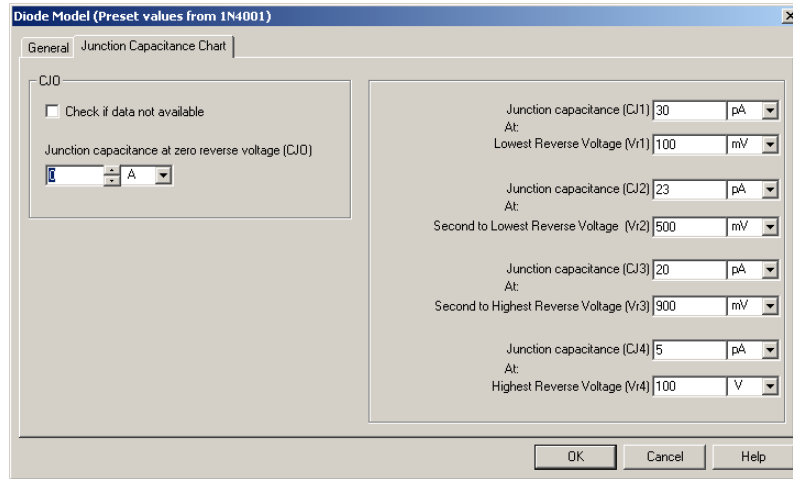

- To enter **Junction Capacitances** data:

1. In the databook, find the “Typical Junction Capacitance” chart — for example:

Point corresponding to the lowest reverse voltage

Select a second point on the curve in the lower voltage area for the second to lowest reverse voltage.

Select a third point on the curve in the lower voltage area for the third to lowest/second to highest reverse voltage

Point corresponding to the highest reverse voltage

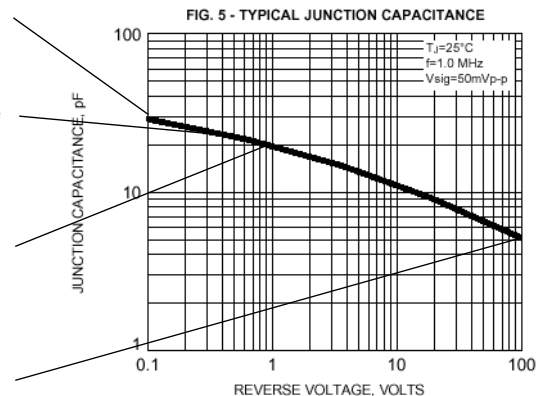

2. Find the junction capacitance at zero reverse voltage and enter it in the **Junction capacitance at zero reverse voltage (CJO)** field.

If this information is not given in the databook, enable **Check if data not available**.

3. Find the point of lowest reverse voltage, or the beginning point of the curve. Use the coordinates of this point to enter the values for:
  - **Junction capacitance (CJ1)**
  - **Lowest Reverse Voltage (Vr1)**.
4. Find the point of highest reverse voltage, or the end point on the curve) and enter the coordinate values in the **Junction capacitance (CJ4)** and **Highest Reverse Voltage (Vr4)** fields.
5. Select two additional intermediate points on the graph, greater than the lowest reverse voltage but in the lower range of the reverse voltage.
6. Use the coordinate values of the second point to enter:
  - **Junction capacitance (CJ2)**
  - **Second to Lowest Reverse Voltage (Vr2)**.
7. Use the coordinate values of the third point to enter:
  - **Junction Capacitance (CJ3)**
  - **Second to Highest Reverse Voltage (Vr3)**

## 8.11.5 Transformers



The following transformer models are available in Multisim:

- “8.11.5.1 Ideal Transformer (Multiple Winding)” on page 8-84
- “8.11.5.2 Linear Transformer (Multiple Winding)” on page 8-85
- “8.11.5.3 Linear Transformer with Neutral Terminal” on page 8-86
- “8.11.5.4 Two Winding Linear Transformer” on page 8-87
- “8.11.5.5 Non-linear Transformer (Multiple Winding)” on page 8-88

### 8.11.5.1 Ideal Transformer (Multiple Winding)



1. From the **Model** tab of the **Component Properties** dialog box, click **Add/Edit**. The **Select a Model** dialog box appears.
2. Click **Start Model Maker**. The **Select Model Maker** dialog box appears.

- From the **Model Maker List**, select **Ideal Transformer (Multiple Winding)** and click **Accept**. (Click **Cancel** to return to the **Model** tab.) The **Ideal Transformer Model** dialog box appears.

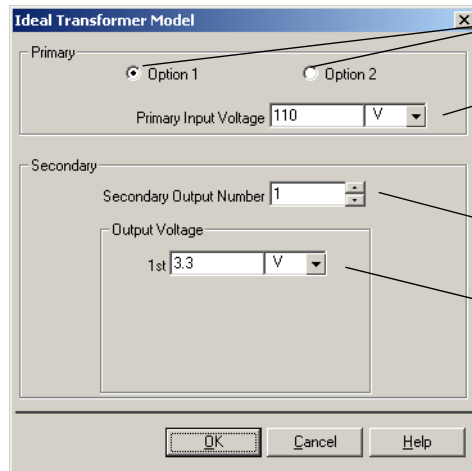

Click Option 1 or Option 2 to quickly select which input voltage to use.

You can also edit the input voltage directly here.

You can increase the number of secondary outputs here.

The number of Output Voltage fields will increase to match the number selected.

- Enter desired values in the **Ideal Transformer Model** dialog box.
- When all values are entered, click **OK** to complete the model, or click **Cancel** to cancel.

### 8.11.5.2 Linear Transformer (Multiple Winding)



- From the **Model** tab of the **Component Properties** dialog box, click **Add/Edit**. The **Select a Model** dialog box appears.
- Click **Start Model Maker**. The **Select Model Maker** dialog box appears.

- From the **Model Maker List**, select **Linear Transformer (Multiple Winding)** and click **Accept**. (Click **Cancel** to return to the **Model** tab.) The **Linear Transformer Model** dialog box appears.

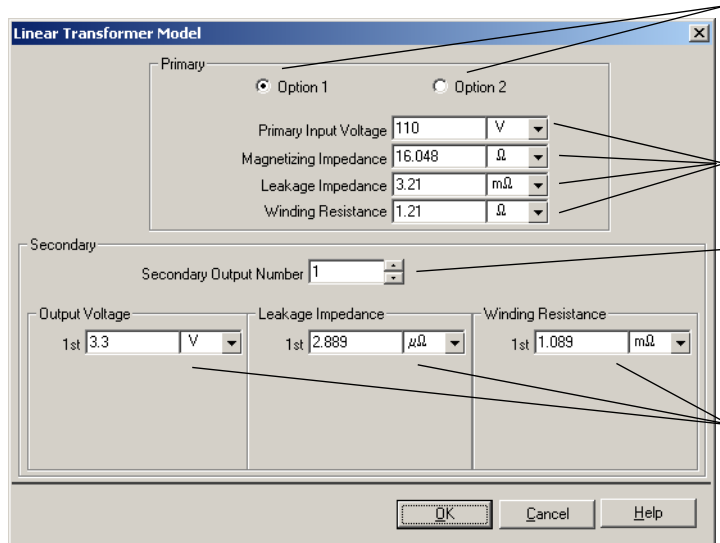

Click Option 1 or Option 2 to quickly select which Primary properties to use.

You can also edit the Primary properties directly.

You can increase the number of secondary outputs here.

The number of these fields will increase to match the number selected.

- Enter desired values in the **Linear Transformer Model** dialog box.
- When all values are entered, click **OK** to complete the model, or click **Cancel** to cancel.

### 8.11.5.3 Linear Transformer with Neutral Terminal



- From the **Model** tab of the **Component Properties** dialog box, click **Add/Edit**. The **Select a Model** dialog box appears.
- Click **Start Model Maker**. The **Select Model Maker** dialog box appears.

- From the **Model Maker List**, select **Linear Transformer with Neutral Terminal** and click **Accept**. (Click **Cancel** to return to the **Model** tab.) The following dialog box appears.

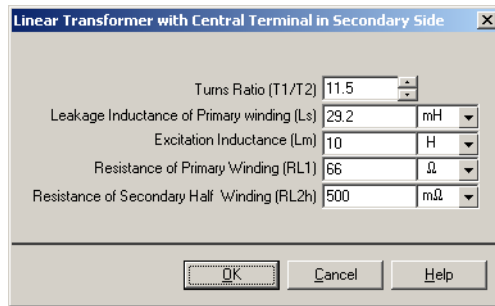

- Enter the desired values in the dialog box.
- When all values are entered, click **OK** to complete the model, or click **Cancel** to cancel.

### 8.11.5.4 Two Winding Linear Transformer



- From the **Model** tab of the **Component Properties** dialog box, click **Add/Edit**. The **Select a Model** dialog box appears.
- Click **Start Model Maker**. The **Select Model Maker** dialog box appears.
- From the **Model Maker List**, select **Two Winding Linear Transformer** and click **Accept**. (Click **Cancel** to return to the **Model** tab.) The **Two Winding Linear Transformer Model** dialog box appears.

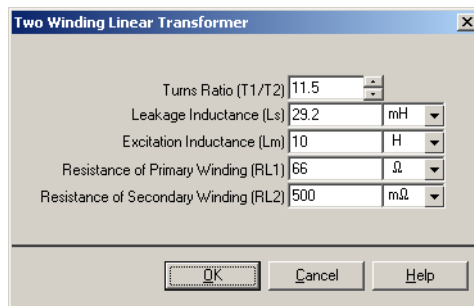

- Enter desired values in the **Two Winding Linear Transformer Model** dialog box.
- When all values are entered, click **OK** to complete the model, or click **Cancel** to cancel.

## 8.11.5.5 Non-linear Transformer (Multiple Winding)



1. From the **Model** tab of the **Component Properties** dialog box, click **Add/Edit**. The **Select a Model** dialog box appears.
2. Click **Start Model Maker**. The **Select Model Maker** dialog box appears.
3. From the **Model Maker List**, select **Non-Linear Transformer (Multiple Winding)** and click **Accept**. (Click **Cancel** to return to the **Model** tab.) The **Non-Linear Transformer Model** dialog box appears.
4. Enter desired values in the **Non-Linear Transformer Model** dialog box as described in the following sections.
5. When all values are entered, click **OK** to complete the model, or click **Cancel** to cancel.

### Entering General Data

Click Option 1 or Option 2 to quickly select which Primary properties to use.

You can also edit the Primary properties directly.

You can increase the number of secondary outputs here.

The number of these fields will increase to match the number selected.

1. Click on the **General** tab.
2. In the **Primary** box, enter the parameters for **Option 1** and **Option 2** as desired.



3. If desired, increase the number of outputs in the **Secondary Output Number** drop-down list. The fields in each of the **Output Voltage**, **Leakage Impedance** and **Winding Resistance** fields increase to match the selection.

Secondary		
Secondary Output Number: 3		
Output Voltage	Leakage Impedance	Winding Resistance
1st: 3.3 V	1st: 2.889 $\mu\Omega$	1st: 1.089 m $\Omega$
2nd: 5 V	2nd: 6.631 $\mu\Omega$	2nd: 2.5 m $\Omega$
3rd: 12 V	3rd: 38.197 $\mu\Omega$	3rd: 14.4 m $\Omega$

4. Enter the desired parameters for each of the secondary outputs (in this example 1st, 2nd and 3rd) in the **Output Voltage**, **Leakage Impedance** and **Winding Resistance** fields.

## Entering Advanced Data

Nonlinear Transformer Model

General | **Advanced**

Primary Turns: 2 k

Core Length: 76.15 mm

Core Area: 130  $\mu\text{m}^2$

B-H Curve

Curve Points: 4

Laminated Sheet B-H curve

Order	B Value	H Value
1	0.000000	0.000000
2	1.000000	13.890000
3	1.500000	51.580000
4	1.700000	222.220000

Sample 1  
 Sample 2  
 Sample 3

OK Cancel Help

1. Click on the **Advanced** tab.
2. Enter the **Primary Turns**, **Core Length** and **Core Area** parameters as required.
3. Use one of the pre-set sample B-H curves (**Sample 1**, **Sample 2** or **Sample 3**), or enter your own **B-H Curve** parameters.
4. Click **OK**.

## 8.11.6 MOSFET (Field Effect Transistor) Model Maker



1. From the **Model** tab of the **Component Properties** dialog box, click **Add/Edit**. The **Select a Model** dialog box appears.
2. Click **Start Model Maker**. The **Select Model Maker** dialog box appears.
3. From the **Model Maker** list, select **MOSFET** and, to continue, click **Accept**. (Click **Cancel** to return to the Model tab.) The **MOSFET Model** dialog box appears.
4. Enter values in the **MOSFET Model** dialog box as described in the following sections.
5. When all values are entered, click **OK** to complete the model, or click **Cancel** to cancel.

**Note** The MOSFET Model dialog box shows preset values for the BS250 model.

### Entering General and Output Characteristics Data

1. Click the **General** tab:

2. Look up data information for the MOSFET in a databook.
- To enter **General** data:
1. Enter the **Channel Type of MOSFET**. This is the title of the datasheet and is found at the top of the datasheet.
  2. Find the “Ratings” table for the MOSFET.
  3. From the data given in the table, enter the **Max Drain Current**.

➤ To enter **Output Characteristics in Ohmic Region** data:

1. From the MOSFET data information, find the  $I_D$  vs.  $V_{DS}$  graph — for example:

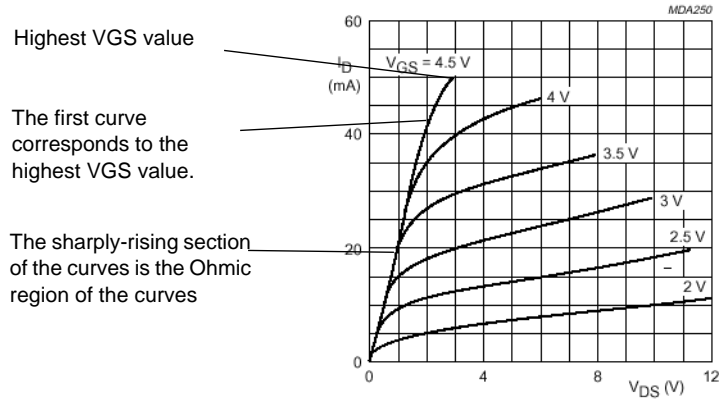

$T_j = 25\text{ }^\circ\text{C}$ .

Fig.3  $V_{SB} = 0$ ; typical values.

2. Locate the curve with the highest  $V_{GS}$ . Enter this  $V_{GS}$  value in the **Vgs for the curve (Vgs\_ohmic)**.
  3. Locate a point in the ohmic region of the same curve.
  4. Enter the  $I_D$  value of this point in the **Drain Current (Ids\_Ohmic)** field.
  5. Enter the  $V_{DS}$  value of this point in the **Vds when drain current is Ids\_Ohmic (Vds\_Ohmic)** field.
- To enter other output characteristics:
1. Using the same graph as above, locate the saturation region of the curves. The saturation region is the steady state situation of the curves where points along the curve fit on a

straight line. (The curve corresponding to the highest VGS does not have a saturation region.) For example:

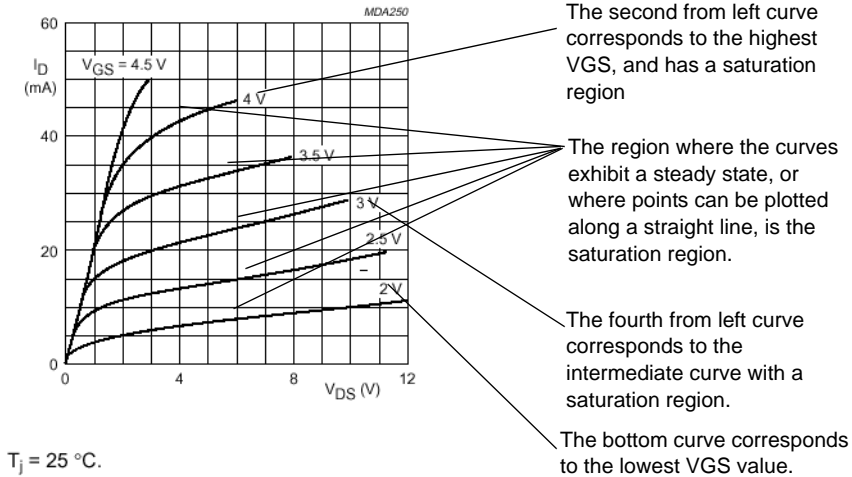

Fig.3  $V_{SB} = 0$ ; typical values.

2. To enter data for the **Ids\_Vds curve 1 (for lowest Vgs)** fields, find the curve with the lowest Vgs value.
  3. Enter the Vgs value of this curve in the **Vgs for this curve (Vgs\_f0)** field.
  4. Using your eye or a ruler, locate the beginning and end points of the saturation region, or the area where the points fit along a straight line, for this curve.
  5. Use the coordinates of the beginning point to enter:
    - **Drain Current (Ids\_f00)**
    - **Vds\_f00 (lower Vds).**
  6. Use the coordinates of the end point to enter:
    - **Drain Current (Ids\_f01)**
    - **Vds\_f01 (higher Vds).**
  7. To enter data for the **Ids\_Vds curve 3 (for highest Vgs)** fields, find the curve with the highest Vgs value, but which still has a saturation region. (This excludes the topmost curve of the Id-Vds graph.)
  8. Repeat steps 3 through 7 to enter values for:
    - **Vgs for this curve (Vgs\_f2)**
    - **Drain Current**
    - **Vds\_f20 (lower Vds)**

- **Drain Current (Ids\_f21)**
  - **Vds\_f21 (higher Vds).**
9. To enter data for the **Ids\_Vds curve 2 (for intermediate Vgs)** fields, find the curve in the middle point between the curves corresponding to the lowest Vgs and the highest VGS with a saturation region.
10. Repeat steps 3 through 7 to enter values for:
- **Vgs for this curve (Vgs\_f1)**
  - **Drain Current (Ids\_f10)**
  - **Vds\_f01 (lower Vds)**
  - **Drain Current (Ids\_f11)**
  - **Vds\_f11 (higher Vds).**

## Entering Transfer Characteristics data

1. Click the **Transfer Characteristics - Option A, B** tab:

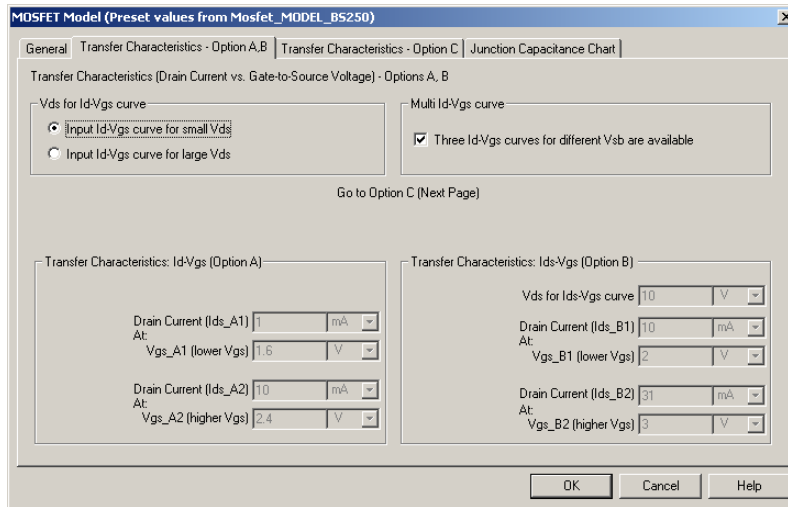

- To select Transfer Characteristics options:

1. In the databook, locate the Id vs. Vgs graph. Depending on the available data, under **Vds for Id-Vgs curve** and **Multi Id-Vgs curve**, enable the appropriate options.

**Note** If the graph contains more than one Vsb curve, it implies that source and bulk (substrate) are not connected together.

If the latter option is not enabled, you will be prompted to enter data in the **Option A** or **Option B** fields on the same dialog box.

If the latter option is enabled (as it is in our example), the dialog box will prompt you to **Go to Option C (Next Page)**.

2. To go to Option C, click the **Transfer Characteristics - Option C** tab:

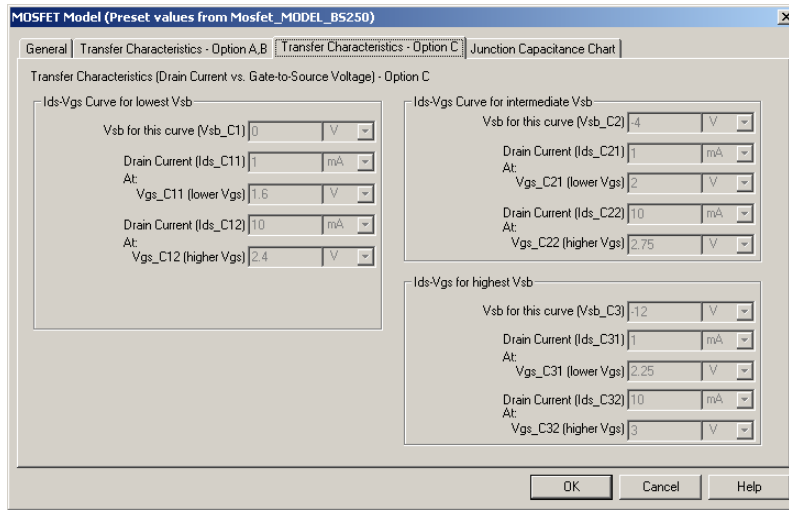

➤ To enter **Transfer Characteristics (Drain Current vs. Gate-to-Source Voltage)** data for all three options (Option A, B, or C):

1. Look at the data in the Ids vs. Vgs graph — for example:

The highest point on the curves corresponds to the maximum Id value.

The leftmost curve corresponds to the lowest Vsb value.

The second from left curve corresponds to the intermediate Vsb value.

The rightmost curve corresponds to the highest Vsb value.

Point corresponding to 10% of maximum Id value

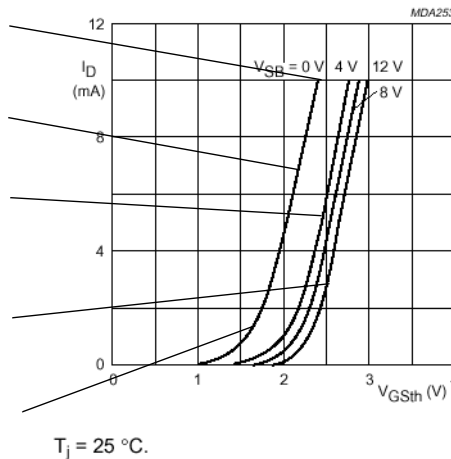

Multiple Vsb curves imply that source-bulk (substrate) are not connected together.

Fig.6  $V_{DS} = V_{GS} = V_{GS(th)}$ .

2. If you are using Option A, proceed to step 4.

If you are using Option B, proceed to step 3.

If you are using Option C, to enter data in the **Ids-Vgs Curve for lowest Vsb** fields, locate the curve with the lowest Vsb.

3. If you are using Option B, enter the Vds value in the **Vds for Ids-Vgs curve** field.

If you are using Option C, enter the Vsb value in the **Vsb for this curve (Vsb\_C1)** field.

4. Find the maximum Id, or the highest point of the curve. Use the coordinates for this point to enter:

for Option A:

- **Drain Current (Ids\_A1)**
- **Vgs\_A1 (lower Vgs)**

for Option B:

- **Drain Current Ids\_B1**
- **Vgs\_B1 (lower Vgs)**

for Option C:

- **Drain Current (Ids\_C11)**
- **Vgs-C11 (lower Vgs)**

5. Find the point on the curve which corresponds to 10% of the maximum Id on the same curve. Use the coordinates of this point to enter:

for Option A:

- **Drain Current (Ids\_A2)**
- **Vgs\_A2 (higher Vgs)**

for Option B:

- **Drain Current (Ids\_B2)**
- **Vgs\_B2 (higher Vgs)**

for Option C:

- **Drain Current (Ids\_C12)**
- **Vgs\_C12 (higher Vgs)**

6. To complete the Option C dialog box, to enter data in the **Ids-Vgs Curve for highest Vsb**, find the curve with the highest Vsb value, and repeat steps 3 through 5 above to enter data for:

- **Vbs for this curve (Vsb\_C3)**
- **Drain Current (Ids\_C31)**
- **Vgs\_C21 (lower Vgs)**
- **Drain Current (Ids\_C32)**
- **Vgs\_C22 (highest Vgs)**

7. To enter data in the **Ids-Vgs Curve for Intermediate Vsb** fields, select the curve corresponding to a Vsb value in between the highest and lowest Vsb. Repeat steps 3 through 5 above to enter data for:

- **Vsb for this curve (Vsb\_C2)**
- **Drain Current (Ids\_C21)**
- **Vgs\_C21 (lower Vgs)**
- **Drain Current (Ids\_C22)**
- **Vgs\_C22 (highest Vgs)**

## Entering Capacitances Data

1. Click the **Junction Capacitance Chart** tab:

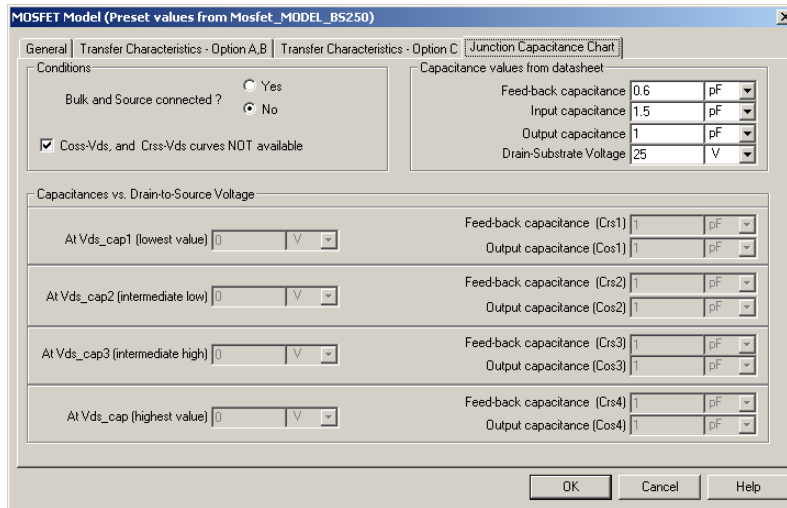

➤ To enter **Conditions**:

1. Determine whether the bulk and source of the model are connected, and select the appropriate answer beside **Bulk and Source connected**.

The substrate condition can be determined by two means. The first is to check the schematic of the device where the internal connections of the MOS transistor are shown.

**Note** The second is to check the Id-Vgs graph. If the graph contains more than one Vsb curve, it suggests that source-bulk (substrate) are not connected together.

2. In the databook, locate the “Capacitances vs. Drain-to-Source Voltage” chart. If it is available, you may enter data in the **Capacitances vs. Drain-to-Source Voltage** fields. If it is not available, enable **Coss-Vds and Crss-Vds curve NOT available**, and use the datasheet to enter capacitances.



- To enter **Capacitance values from datasheet**:
1. In the databook, find the “Characteristics” table.
  2. From the table, enter data for:
    - **Feedback capacitance**
    - **Input capacitance**
    - **Output capacitance**
    - **Drain-Substrate Voltage**

## 8.11.7 Operational Amplifier Model Maker



1. From the **Model** tab of the **Component Properties** dialog box, click **Add/Edit**. The **Select a Model** dialog box appears.
2. Click **Start Model Maker**. The **Select Model Maker** dialog box appears.
3. From the **Model Maker** list, select **Operational Amplifier** and, to continue, click **Accept**. (Click **Cancel** to return to the Model tab.) The **Operational Amplifier Model** dialog box appears.
4. Enter values on the **Operational Amplifier Model** dialog box as described in the following sections.
5. When all values are entered, click **OK** to complete the model, or click **Cancel** to cancel.

**Note** The **Operational Amplifier Model** dialog box shows preset values for the  $\mu$ A741 model.

## Entering General and Input Data

1. Click the **General, Input** tab:

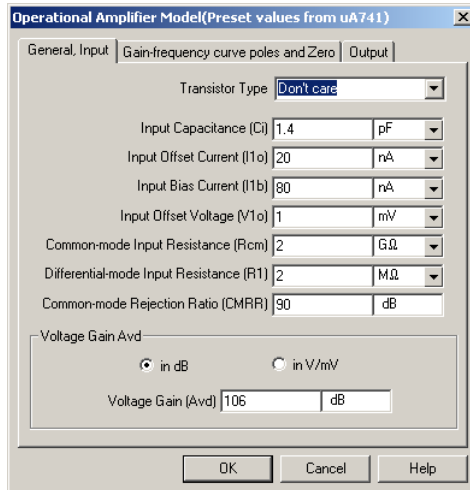

2. Look up data information for the operational amplifier in a databook.

➤ To enter **General** data:

1. In the **Transistor Type** field, select the type of transistor used in the input stage. This can be determined by looking at the schematic of the internal structure of the opamp.

**Note** This information is optional, as the opamp model can be based on any type of input transistor. If the type of the input transistor is not important, select “Don’t Care”.

➤ To enter input data:

1. In the databook, find the two tables labeled “Electrical Characteristics at specified free-air temperature”.

2. Use the data from these tables to enter:

- **Input Capacitance (Ci)**
- **Input Offset Current (I1o)**
- **Input Bias Current ((I1b)**
- **Input Offset Voltage (V1o)**
- **Common-mode Input Resistance (Rcm)**
- **Differential-mode Input Resistance (R1)**
- **Common-mode Rejection Ratio (CMRR)**
- **Voltage Gain Avd**

**Note** The Common-Mode input resistance is usually very high. If its value is not available, choose 2 Gohm as the default.

**Note** While the typical value for the Common-Mode Rejection Ratio (CMRR) is provided in the “Electrical Characteristics” table, its variations with frequency are also provided in a chart called “Common-Mode Rejection Rate Vs. Frequency”. If you use this chart, use the CMRR value for the lowest frequency possible.

**Note** While the typical value for Large Signal Differential Voltage Amplification (Avd) is provided in the “Electrical Characteristics” table, you can also find it in a chart called “Open-Loop Large Signal Differential Voltage”. If you use this chart, use the Avd value at the lowest frequency.

**Note** Databooks provide Avd gain in either dB or V/mV. If the value is provided in V/mV, you can still enter the data in dB. However, you should convert the numerical values:  
 $value\ in\ dB = 20 * \log[1000 * (value\ in\ V/mv)]$

## Entering Poles and Zero Data

1. Click the **Gain frequency curve poles and Zero** tab:

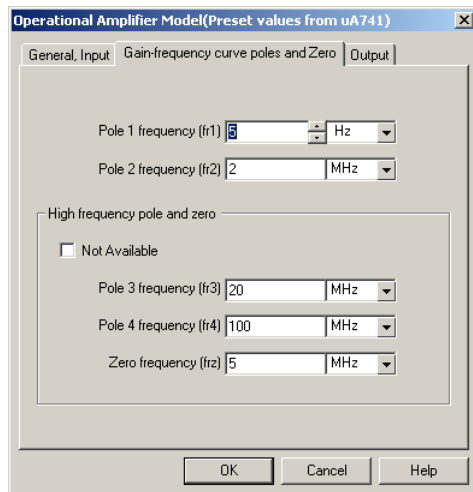

- To enter **Gain-frequency curve poles and Zero** data:
  1. In the databook, locate the “Avd-Open-Loop Single Differential Voltage Amplification vs. Frequency” chart — for example:

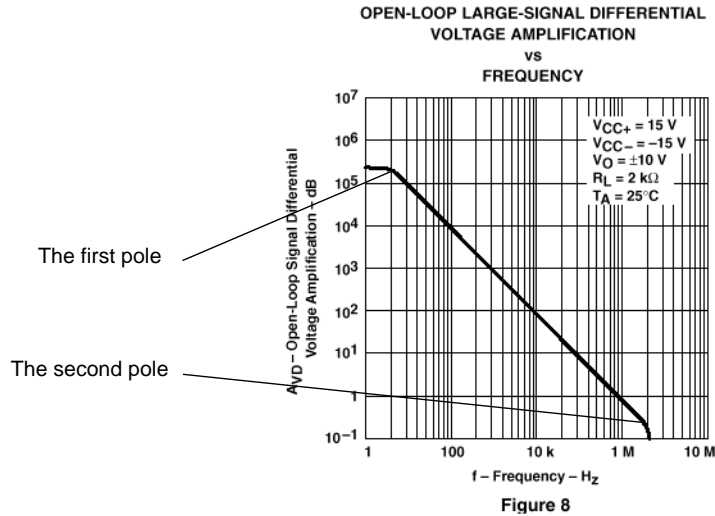

2. Find the first pole on the curve, or the point on the curve where the first horizontal line transitions into a slope. Enter the frequency value for this point in the **Pole 1 frequency (fr1)** field.
  3. Find the second pole on the curve, or the point where the slope transitions into a sharper slope. Enter the frequency value for this point in the **Pole 2 frequency (fr2)** field.
- To enter **High frequency pole and zero** data, find higher frequency poles using the curve mentioned above, web sites or books. If these pieces of information are not available, enable **Not Available**.

## Entering Output Data

1. Click the **Output** tab:

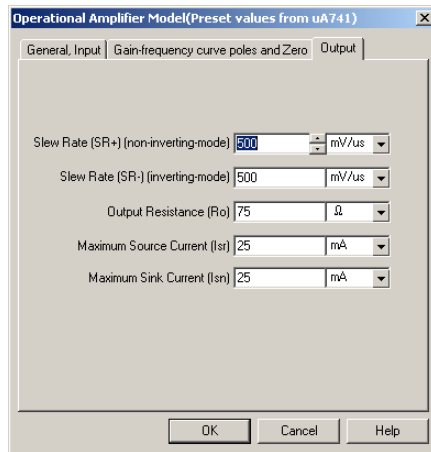

2. In the databook, locate the “Operating Characteristics” table.
3. Use the data from this table to enter:
  - **Slew Rate (SR+) (non-inverting mode)**
  - **Slew Rate (SR-) (inverting mode)**

**Note** Databooks may provide only one value for both inverted and non-inverted slew rates.

4. Refer to the “Electrical Characteristics” tables mentioned in the previous section. Use the data from these tables to enter:
  - **Output Resistance (Ro)**
  - **Maximum Source Current (Isr)**
  - **Maximum Sink Current (Isn)**

**Note** Databooks normally provide the short circuit output current. This is the maximum value of the output current which the output node can provide if it is connected to the negative power supply, or can accept if it is shorted to the positive power supply. You should enter its value regardless of its sign.

## 8.11.8 Silicon Controlled Rectifier Model Maker



1. From the **Model** tab of the **Component Properties** dialog box, click **Add/Edit**. The **Select a Model** dialog box appears.
2. Click **Start Model Maker**. The **Select Model Maker** dialog box appears.
3. From the **Model Maker** list, select **SCR** and, to continue, click **Accept**. (Click **Cancel** to return to the Model tab.) The **SCR Model** dialog box appears.
4. Enter values on the SCR Model dialog box as described in the following sections.
5. When all values are entered, click **OK** to complete the model, or click **Cancel** to cancel.

**Note** The **SCR Model** dialog box shows preset values for the 2N6504 SCR.

### Entering Electrical and Maximum Forward Voltage Data

1. Click the **Electrical Characteristics, Max Forward Voltage** tab:

The screenshot shows the 'SCR Model (Preset values from 2N6504)' dialog box. It has two tabs: 'Electrical Characteristics, Max Forward Voltage' (selected) and 'Time Data, Max Ratings'. The 'Electrical Characteristics' section contains the following fields:

Holding Current	65	mA
Gate Trigger Current	25	mA
Gate Trigger Voltage	1	V
Peak Forward Blocking Current	10	μA
Peak Forward Blocking Voltage	50	V
1.05 Peak Reverse Blocking Voltage	52.5	V
Critical Rate of Rise of Off-State Voltage	50	V/μs

The 'Maximum Forward Voltage Chart' section contains the following fields:

Instantaneous Forward Current At:	100	mA
Minimum value of instantaneous voltage	870	mV
Instantaneous Forward Current At:	3	A
Intermediate value of instantaneous voltage	1	V
Instantaneous Forward Current At:	100	A
Maximum value of instantaneous voltage	2.54	V

Buttons at the bottom: OK, Cancel, Help.

2. Look up data information for the SCR in a databook.

- To enter **Electrical Characteristics** data:
  1. Locate the “Electrical Characteristics” table — for example:

Use this information to enter data in the Electrical Characteristics fields under the Electrical Data, Max Forward Voltage tab.

Use this information to enter data in the Electrical Characteristics fields of under the Time Data, Max Ratings tab. See “Entering Time Data and Maximum Ratings Data” on page 8-105.

**ELECTRICAL CHARACTERISTICS** ( $T_C = 25^\circ\text{C}$  unless otherwise noted.)

Characteristic	Symbol	Min	Typ	Max	Unit
*Peak Forward or Reverse Blocking Current ( $V_{AK} = \text{Rated } V_{DRM}$ or $V_{RRM}$ , Gate Open) $T_J = 25^\circ\text{C}$ $T_J = 125^\circ\text{C}$	$I_{DRM}$ , $I_{RRM}$	—	—	10 2	$\mu\text{A}$ $\text{mA}$
*Forward “On” Voltage(1) ( $I_{TM} = 50 \text{ A}$ )	$V_{TM}$	—	—	1.8	Volts
*Gate Trigger Current (Continuous dc) (Anode Voltage = 12 Vdc, $R_L = 100 \text{ Ohms}$ ) $T_C = 25^\circ\text{C}$ $T_C = -40^\circ\text{C}$	$I_{GT}$	—	—	40 75	$\text{mA}$
*Gate Trigger Voltage (Continuous dc) (Anode Voltage = 12 Vdc, $R_L = 100 \text{ Ohms}$ , $T_C = -40^\circ\text{C}$ )	$V_{GT}$	—	1	1.5	Volts
Gate Non-Trigger Voltage (Anode Voltage = Rated $V_{DRM}$ , $R_L = 100 \text{ Ohms}$ , $T_J = 125^\circ\text{C}$ )	$V_{GD}$	0.2	—	—	Volts
*Holding Current (Anode Voltage = 12 Vdc, $T_C = -40^\circ\text{C}$ )	$I_H$	—	35	40	$\text{mA}$
*Turn-On Time ( $I_{TM} = 25 \text{ A}$ , $I_{GT} = 50 \text{ mA}$ )	$t_{gt}$	—	1.5	2	$\mu\text{s}$
Turn-Off Time ( $V_{DRM} = \text{rated voltage}$ ) ( $I_{TM} = 25 \text{ A}$ , $I_R = 25 \text{ A}$ ) ( $I_{TM} = 25 \text{ A}$ , $I_R = 25 \text{ A}$ , $T_J = 125^\circ\text{C}$ )	$t_q$	—	15 35	— —	$\mu\text{s}$
Critical Rate of Rise of Off-State Voltage (Gate Open, Rated $V_{DRM}$ , Exponential Waveform)	$dv/dt$	—	50	—	$\text{V}/\mu\text{s}$

\*Indicates JEDEC Registered Data.

1. Pulse Test: Pulse Width  $\leq 300 \mu\text{s}$ , Duty Cycle  $\leq 2\%$ .

2. Based on the data provided in this table, enter:
  - **Holding Current**
  - **Gate Trigger Current**
  - **Gate Trigger Voltage**
  - **Peak Forward Blocking Current**
  - **Critical Rate of Rise of Off-State Voltage**
3. In the databook, locate the “Maximum Ratings” table.
4. Based on the data in the table, enter the value of the **Peak Forward Blocking Voltage** field.
5. Multiply this value by 1.05 and enter the value in the **1.05 Peak Reverse Blocking Voltage** field.

- To enter **Maximum Forward Voltage Chart** data:
1. In the databook, locate the “Instantaneous Forward Current vs. Instantaneous Voltage” graph, and find the  $I_f$ - $V_f$  curve at 25°. For example:

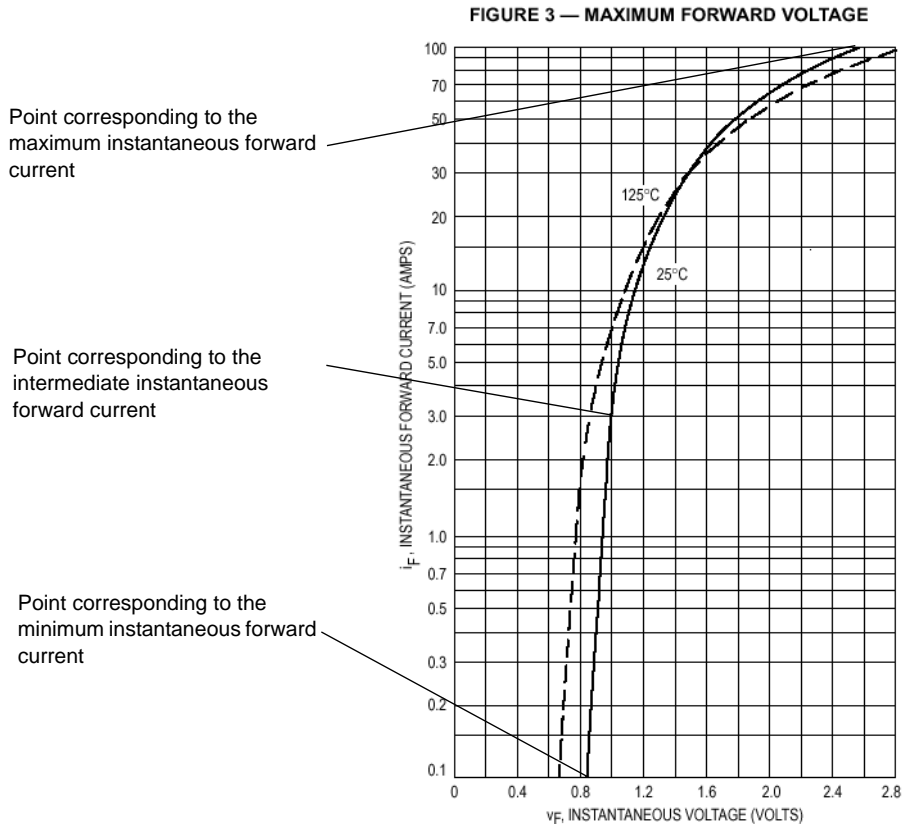

2. On the curve, find the point at the minimum  $I_f$ , or the beginning point of the curve. Use the coordinates of this point to enter:
  - **Instantaneous Forward Current.**
  - **Minimum value of instantaneous voltage.**
3. Find the point at the maximum  $I_f$ , or the end point of the curve. use the coordinates of this point to enter:
  - **Instantaneous Forward Current**
  - **Maximum value of instantaneous voltage.**
4. Locate an intermediate point on the curve corresponding to the transition point. Since the graph is provided in logarithmic format, you can do this by using a ruler to draw a line starting at the beginning point and following the straight line of the curve in the lower



voltage area. Where the curve begins to diverge from your ruler, use this point as your intermediate point. Use the coordinates of this point to enter:

- **Instantaneous Forward Current**
- **Intermediate value of instantaneous voltage**

## Entering Time Data and Maximum Ratings Data

1. Click the **Time Data, Max Ratings** tab:

The screenshot shows the 'SCR Model (Preset values from 2N6504)' dialog box with the 'Time Data, Max Ratings' tab selected. The 'Electrical Characteristics' section contains two input fields: 'Turn-On Time' with a value of 100 and a unit of μs, and 'Turn-Off Time' with a value of 15 and a unit of μs. The 'Maximum Ratings Chart' section contains several input fields: 'Forward Current' (25 A), 'Reverse Current (Irc) when the device is in "off-state". If n/a enter 0' (0 A), 'Reverse Voltage (Vrc) when the device is in "off-state". If n/a enter 0' (0 V), 'Identifier (Equal to 1 if above Irc and Vrc values available, otherwise 0)' (0), 'Parameter related to "off-state". (Equal to zero if above Irc and Vrc values available, otherwise equal to Forward Current)' (25 A), and 'Parameter related to "off-state". (Equal to zero if above Irc and Vrc values available, otherwise equal to Peak Reverse Blocking Voltage)' (50 V). At the bottom, there are 'OK', 'Cancel', and 'Help' buttons.

- To enter **Electrical Characteristics** data, refer to the “Electrical Characteristics” table mentioned in the previous section, and enter data in the **Turn-On Time** and **Turn-Off Time** fields.
- To enter **Maximum Ratings Chart** data:
  1. Refer to the “Maximum Ratings” table mentioned in the previous section.
  2. Find the Forward Current and enter this value in the **Forward Current** field.
  3. For the **Reverse Current** field, find the reverse current (IRC) when the device is in off-state and enter this value, or, if this value is not provided, enter 0.
  4. For the **Reverse Voltage** field, find the reverse voltage (VRC) when the device is in off-state or, if this value is not provided, enter 0.
  5. For the **Identifier** field, enter 1 if Reverse Current and Reverse Voltage values are available, or 0 if they are unavailable.

6. For the first **Parameter related to “off-state”** field, enter 0 if the Reverse Current and Reverse Voltage values are available, or, if they are not provided, enter the Forward Current value.
7. For the second **Parameter related to “off-state”** field, enter 0 if the Reverse Current and Reverse Voltage values are available, or, if they are not provided, enter the Peak Reverse Blocking Voltage value.

## 8.11.9 Zener Model Maker



1. From the **Model** tab of the **Component Properties** dialog box, click **Add/Edit**. The **Select a Model** dialog box appears.
2. Click **Start Model Maker**. The **Select Model Maker** dialog box appears.
3. From the **Model Maker** list, select **Zener** and, to continue, click **Accept**. (Click **Cancel** to return to the **Model** tab.) The **Zener Model** dialog box appears.
4. Enter values on the **Zener Model** dialog box as described in the following sections.
5. When all values are entered, click **OK** to complete the model, or click **Cancel** to cancel.

**Note** The **Zener Model** dialog box shows preset values for the IN4728A model.

### Entering Electrical Characteristics Data

1. Click the **Electrical Characteristics** tab:

The screenshot shows the 'Zener Model (Preset values from IN4728A)' dialog box with the 'Electrical Characteristics' tab selected. The dialog is divided into two main sections: 'Reverse Characteristics' and 'Forward Characteristics'. Each section contains several input fields with units, and a 'Help' button is located at the bottom right.

Section	Parameter	Value	Unit
Reverse Characteristics	Nominal Zener Voltage (Vz)	6.8	V
	At: Zener Test Current (Izt)	76	mA
	Nominal Zener Impedance at Vz and Izt (Zzt)	4	Ω
	At: Leakage Current (Itr)	100	μA
	At: Reverse Test Voltage (Vr)	1	V
	Zener Impedance near Breakdown Knee (Zzk)	300	Ω
Zener Current near Breakdown Knee (Izk)	1	mA	
Forward Characteristics	Forward Current (If1)	1	mA
	At: Lowest Forward Voltage (Vf1)	730	mV
	Forward Current (If2)	10	mA
	At: Intermediate Forward Voltage (Vf2)	800	mV
Highest Forward Current (Ifm)	200	mA	
At: Highest Forward Voltage (Vfm)	1.05	V	

2. Look up data information for the Zener diode in a databook.

3. From the databook, locate the “Electrical Characteristics” table — for example:

Use the information from this table to enter data in the Reverse Characteristics fields.

**\*ELECTRICAL CHARACTERISTICS** ( $T_A = 25^\circ\text{C}$  unless otherwise noted)  $V_F = 1.2\text{ V Max}$ ,  $I_F = 200\text{ mA}$  for all types.

JEDEC Type No. (Note 1)	Nominal Zener Voltage $V_Z @ I_{ZT}$ Volts (Notes 2 and 3)	Test Current $I_{ZT}$ mA	Maximum Zener Impedance (Note 4)			Leakage Current		Surge Current @ $T_A = 25^\circ\text{C}$ $I_{r - mA}$ (Note 5)
			$Z_{ZT} @ I_{ZT}$ Ohms	$Z_{ZK} @ I_{ZK}$ Ohms	$I_{ZK}$ mA	$I_R$ $\mu\text{A Max}$	$V_R$ Volts	
1N4728A	3.3	76	10	400	1	100	1	1380
1N4729A	3.6	69	10	400	1	100	1	1260
1N4730A	3.9	64	9	400	1	50	1	1190
1N4731A	4.3	58	9	400	1	10	1	1070
1N4732A	4.7	53	8	500	1	10	1	970
1N4733A	5.1	49	7	550	1	10	1	890
1N4734A	5.6	45	5	600	1	10	2	810
1N4735A	6.2	41	2	700	1	10	3	730
1N4736A	6.8	37	3.5	700	1	10	4	660
1N4737A	7.5	34	4	700	0.5	10	5	605
1N4738A	8.2	31	4.5	700	0.5	10	6	550

➤ To enter **Reverse Characteristics** data, use the information from the table for the following fields:

- **Nominal Zener Voltage ( $V_{zt}$ )**
- **Zener Test Current ( $I_{zt}$ )**
- **Nominal Zener Impedance at  $Z_{zt}$  and  $I_{zt}$  ( $Z_{zt}$ )**
- **Leakage Current ( $I_r$ )**
- **Reverse Test Voltage ( $V_r$ )**
- **Zener Impedance near Breakdown Knee ( $Z_{zk}$ )**
- **Zener Current near Breakdown Knee ( $I_{zk}$ )**

**Note** In the example, the databook only provides the maximum Zener impedance. To find a typical value for  $Z_{zk}$ , use 0.75 times the maximum value of  $Z_{zk}$ . To find the typical value of  $Z_{zt}$ , you can use the  $Z_z$ - $I_z$  graph. Find or estimate a curve at the nominal zener voltage given in the table, and choose the point which corresponds to the test current given in the table. Use the  $Z_z$  coordinate of this point to enter as the typical value.

➤ To enter **Forward Characteristics** data:

1. In the databook, locate the  $I_f$ - $V_f$  graph, and find the maximum curve at  $25^\circ$  — for example:

The sixth from left curve is the maximum curve at  $25^\circ$ .

Point corresponding to maximum forward voltage

Point corresponding to intermediate forward voltage

Point corresponding to minimum forward voltage

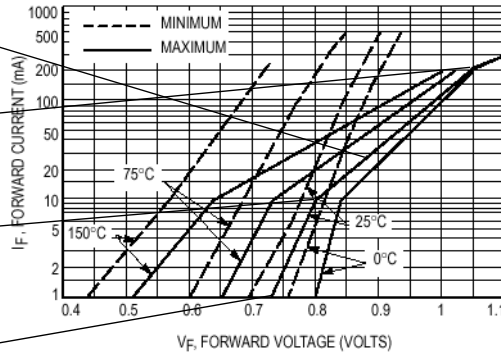
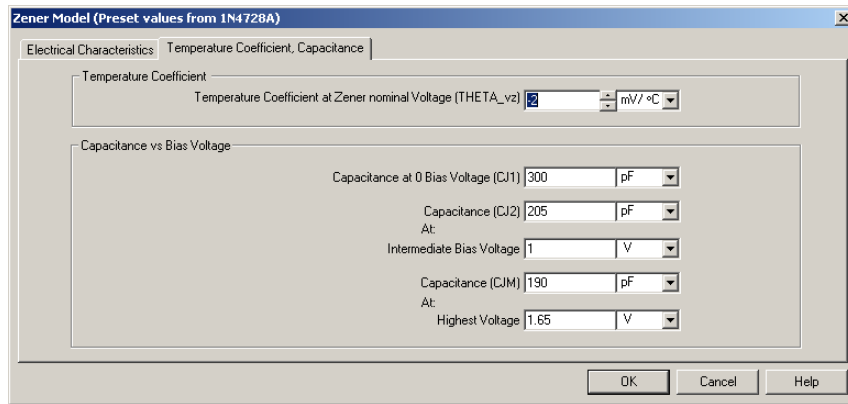

**Figure 10. Typical Forward Characteristics**

2. Find the point on the curve with the lowest forward voltage, or the beginning point. Use the coordinates of this point to enter:
  - **Forward Current (If1)**
  - **Lowest Forward Voltage (Vf1)**
3. Find the knee point on the curve, or the point where the slope changes drastically. Use the coordinates of this point to enter:
  - **Forward Current (If2)**
  - **Intermediate Forward Voltage (Vf2)**
4. Find the point of maximum forward voltage, or the highest point on the curve. Use the coordinates of this point to enter:
  - **Highest Forward Current (Ifm)**
  - **Highest Forward Voltage (Vfm)**

## Entering Temperature Coefficient and Capacitance Data

1. Click the **Temperature Coefficient, Capacitance** tab:



To enter **Temperature Coefficient** data:

1. From the databook, find the Temperature Coefficient versus Zener Voltage graph — for example:

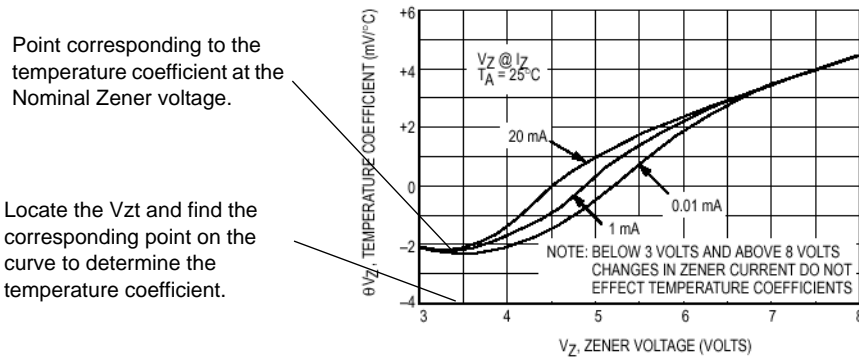

Figure 4. Effect of Zener Current

2. Locate the curve corresponding to the model's test current as given in the "Electrical Characteristics" table. (If it is not on the graph, estimate its placement.)
3. Find the point corresponding to the model's  $V_z$ , as provided in the "Electrical Characteristics" table. Enter the Temperature Coefficient for this point in the **Temperature Coefficient at Zener Nominal Voltage (THETA\_vz)** field.

➤ To enter **Capacitance vs. Bias Voltage** data:

1. In the databook, locate the “Capacitance versus Nominal Vz” graph — for example:

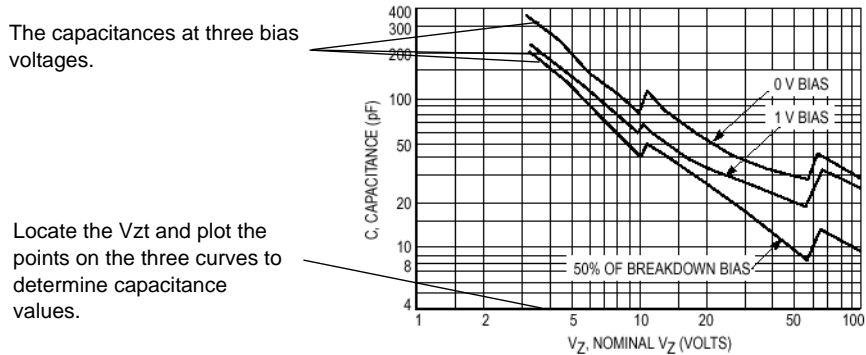

Figure 9. Typical Capacitance versus Vz

2. On each of the three curves in the graph, locate the point corresponding to the Vz<sub>t</sub> provided in the “Electrical Characteristics” table.
3. For the curve at zero bias voltage, use this point to enter the capacitance value in the **Capacitance at 0 Bias Voltage (CJ1)** field.
4. For the intermediate curve, enter its bias voltage in the **Intermediate Bias Voltage** field and enter the capacitance value for the point you have marked in the **Capacitance (CJ2)** field.
5. For the curve with the highest voltage, enter its bias voltage in the **Highest Voltage** field. (In our example, this value is 50% of the nominal Zener voltage (Vz<sub>t</sub>) of the model, as provided in the “Electrical Characteristics” table.) Enter the capacitance value for the point you have marked in the **Capacitance (CJM)** field.

## 8.12 Creating a Model Using Code Modeling



This section explains how to model a component using a high-level, industry-standard programming language: C. The component can then be added to the Multisim database. To use code modeling you must have a C compiler such as Microsoft Visual C++, Version 4.1 or greater, and be familiar with programming and compiling C code. This section is not designed for Multisim users without programming exposure.

Multisim has built-in models for most types of devices, but it is impossible to provide models for every possible device. The behavior of some devices may be extremely difficult to model as groups of SPICE components, but may be easier to describe in terms of high-level, behavioral equations. As a result, the behavior of these devices can be modeled using code modeling.

**Note** See also, “8.6 Editing a Component’s Model” on page 8-38.

### 8.12.1 What is Code Modeling?

Code modeling is the behavioral modeling of devices whose governing equations are known.

**Note** This section serves as a basic guide to code modeling and includes helpful examples. However, code modeling is a complex process, so be aware that you need time and practice to gain proficiency.

A code model consists of a set of interface definitions and a C function implementation describing the device’s behavior. The naming and location of these files is important. The model is created by combining two files (`Ifspec.ifs` and `Cfunc.mod`). The resulting file, which is given the same name as the folder containing its source files, is placed in the `codemodl` folder.

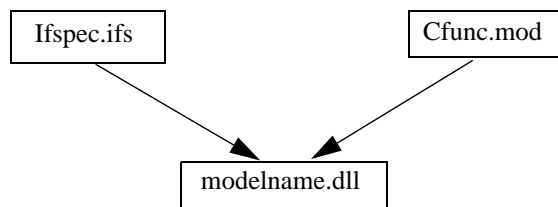

## 8.12.2 Creating a Code Model

For a specific example of compiling and using a code model, see “GAINTEST Example” on page 8-113. For best results, do all of the following steps from a DOS command window.

- To create a code model:
  1. Set up your environment variables for Microsoft Visual C++ by running `VcVars32.bat` (installed, by default, in the `c:/Program Files/Microsoft Visual Studio/Vc98/Bin` folder).
  2. Find a directory in the same directory as your Multisim executable called `codemod1`. Within this directory should be a single subdirectory called `USER`. You should create new subdirectories inside of `USER`, one for each of your code models. The name of the subdirectory will end up being the name of the code model executable.
  3. Create a new interface file inside your model's subdirectory called `Ifspec.ifs` to set up your model's basic definitions and interface (i/o ports and parameters).
  4. Create a new implementation file inside your model's subdirectory called `Cfunc.mod`. This file contains the actual code model.
  5. It is critical that the `Cfunc.mod` file include a list of all models in the file in the following format:

```
SPICEdev * FAR DynDEVICES [] = {  
    &<function_name>_info  
};
```

Where `<function_name>` is the “C\_Function\_Name” defined in your `Ifspec.ifs` file. This is a special Multisim requirement, so this line may need to be added to code models used from other sources. It is recommended that you use a function name beginning with “`cm_`”.

6. To compile the files into a form that can be used by Multisim, go to the `codemod1\USER` folder and execute the following command:

```
MAKE_DLL <subdirectory>
```

Where `<subdirectory>` is the directory where you have put your code model files.

7. If the compilation is successful, you will find a new `.dll` file inside the subdirectory, which is the executable code model. You *must* copy or move this `.dll` file into the main `codemod1` directory in order for Multisim to find it.
8. **Important:** If Multisim is running, you must exit and restart it in order to access new code models. Multisim only loads user code models on startup.



9. In order to use your code model in Multisim, choose a model in the normal way in the component wizard, and select “Load from File”. Set the file type in the dialog to “**Code Model DLL(\*.dll)**”, and browse to the `codemodl` directory if necessary. Select the `.dll` file you just created.
10. If you have not altered the `codemodl` directory structure, the model name and spice model name will be automatically populated from the `ifspec.ifs` file. The format should look as follows:

```
.MODEL <DLL> <name>(<params>)
```

Where `<DLL>` is the `.dll` name of your model (without the `.dll` extension), `<name>` is the “`Spice_Model_Name`” from your `Ifspec.ifs`, and `<params>` is an optional list of the type “`<param_name> = <default value>`” separated by spaces (*not* commas), and serves to override any default parameter values defined in `Ifspec.ifs`. Delete the string “`_INSERT_PARAMS`” and type in your desired parameters, or leave the parentheses empty if you wish to use all defaults.

## GAINTEST Example

The GAINTEST example is included in the Multisim install. (Note: This example assumes familiarity with the Component Wizard.)

1. Set up your environment variables for Microsoft Visual C++ by running `VcVars32.bat` (installed, by default, in the `c:/Program Files/Microsoft Visual Studio/Vc98/Bin` folder).
2. In your Multisim executable directory, go to the subdirectory called `codemodl\USER\GAINTEST`. Notice that it contains only two files: `Ifspec.ifs` and `Cfunc.mod`.
3. If you wish, you may examine the **Ifspec.ifs** file for the GAINTEST model. This defines many of the important characteristics of the GAINTEST model:
  - The `C_Function_Name` (`cm_gaintest`)
  - The `Spice_Model_Name` (`gaintest`)
  - One input port (analog: voltage, differential voltage, current, or differential current).
  - One output port (same options as the input).
  - Three model parameters (`in_offset`, `gain`, and `out_offset`). Note that each parameter is given a plaintext description, a data type, and a default value. All three of them have `Null_Allowed` defined as “yes”, so they are all optional parameters. If any of these parameters are omitted when calling the model, the default value will be used.
4. If you wish, you may examine the `Cfunc.mod` file for the GAINTEST model. This file contains the actual code model – a simple C language function with the same name defined as `C_Function_Name` in the `Ifspec.ifs` file. Note use of XSpice keywords

such as INPUT, OUTPUT, PARAM, PARTIAL, and AC\_GAIN. Note also the use of the model parameters defined in the `Ifspec.ifs` file.

5. Note that the `GAINTEST Cfunc.mod` file includes the following:

```
SPICEdev * FAR DynDEVICES[] = {  
    &cm_gaintest_info  
};
```

as required by Multisim.

6. To compile the `GAINTEST` model, go to the `codemod1\USER` folder and execute the following command:

```
MAKE_DLL GAINTEST
```

After successful completion, note that two new files have been created in the `GAINTEST` directory: `Gaintest.c` and `Gaintest.dll`:

- The `Gaintest.c` file contains all the information from the `Ifspec.ifs` and `Cfunc.mod` files, expanded into a format understood by the Microsoft Visual C compiler and the Multisim implementation of XSpice. If you examine this file, you'll notice that all of the XSpice keywords have been replaced with fairly complex structure and array references.
  - The `Gaintest.dll` file contains the compiled code model, ready for execution.
7. Move this `Gaintest.dll` file into the main `codemod1` directory so that Multisim may find it.
  8. If Multisim is running, you must exit and restart it so that it may load the new `GAINTEST` model. Multisim only recognizes new code models on startup.
  9. In Multisim, run the component wizard as follows:
    - Create an analog component, simulation only.
    - Give the part two pins, one input and one output.
    - On the "Select Simulation Model" step, click on the "Load from File" button.
    - In the file-selection dialog that appears, change the filter to "Code Model DLL (\*.dll)" and browse to the `codemod1` directory if necessary.
    - Select the `Gaintest.dll` file and click "Open".
    - The model name should change to "GAINTEST" and the model data to ".MODEL GAINTEST gaintest(\_INSERT\_PARAMS)"
    - In the "Model Data" section, change `_INSERT_PARAMS` to **gain=2.0** (this creates a part that multiplies the input voltage by two).
    - In the pin mapping section, change the "SPICE Model Type" to "XSpice model(a)"
    - Finally, put this model in some logical place in your User Database.

10. Create a new circuit and place your new part in series. You may verify that any voltage applied to the part (DC or AC) will be doubled on output. If you wish, you may edit the part's model on the circuit to adjust the gain parameter, or add in values for the in\_offset or out\_offset parameters as well.

## 8.12.3 The Interface File (Ifspec.ifs)

The interface file sets out, in tables, the names used by the model, the electrical connections to the devices (ports), and the user-defined variables (parameters) that provide finer control over the behavior of the model. These tables are explained in this section, with examples given for each. An example of an interface file is shown in “8.12.3.4 Example Interface File” on page 8-120. The interface file, along with the implementation file, needs to be compiled into a DLL to complete the code model.

### 8.12.3.1 Name Table

The model name, description text, and C implementation function name are defined in the name table. The model name must be the same as the subdirectory containing the code model files. It is recommended that the model name be eight characters.

The name table has the following syntax:

```
NAME_TABLE:
```

```
C_Function_Name:function_name  
Spice_ModelName:model_name  
Description:      "text"
```

where:

`function_name` is a valid C identifier which is the name of the main entry point (function) for the code model. It may or may not be the same as the SPICE model name. To reduce the chance of name conflicts, we recommend you use the prefix "UCM\_" for user code model, or use a prefix based on your own initials. The following prefixes are used by the XSPICE simulator core and should not be used for user code models:

A2VERI	D_OPEN_C	EW_RES	POLY
A2VHDL	D_OPEN_E	EW_SCR	POT
A_555	D_OR	EW_SWTCH	PPT
ADC_BRDG	D_OSC	EW_VLT	PWL
ASRC	D_PULLDN	FTE	R_2_V
ASWITCH	D_PULLUP	GAIN	RDELAY
BJT	D_RAM	HLP	RES
BSIM	D_ROM	HYST	RGAIN
CAP	D_SERIALPORT	ICM	S_XFER
CCCS	D_SOURCE	IDN	SCR
CCVS	D_SRFF	ILIMIT	SINE
CKT	D_SRLATC	IND	SLEW
CLIMIT	D_STATE	INDUCTOR	SMP
CM	D_TFF	INP	SQUARE
CMETER	D_TRISTA	INT	SRC_LVM
CORE	D_VERI	IPC	SRC_LVM_CUR
CP	D_VERILOG	ISRC	SRC_TDM
CSW	D_VHDL	JFET	SRC_TDM_CUR
D_2_R	D_WGEN	LCOUPLE	SUMMER
D_AND	D_XNOR	LIMIT	SW
D_BUFFER	D_XOR	LMETER	TRA
D_CHIP	DAC_BRDG	MES	TRIANGLE
D_CPU	DAC_HIZ	MFB	URC
D_CPUPIC	DEV	MIF	VCCS
D_DFF	DIO	MOS1	VCVS
D_DLATCH	DIVIDE	MOS2	VERIZA
D_DT	ENH	MOS3	VHDL2A
D_FDIV	EVT	MULT	VHDL2HIZ
D_INV	EW_CAP	N1	VSRC
D_JKFF	EW_IND	NCO	XCAP
D_NAND	EW_NLA2D	NOISE	ZENER
D_NOR	EW_NOISE	ONESHOT	

`model_name` is a valid SPICE identifier which will be used on SPICE deck .model records to refer to this code model. It may or may not be the same as the C function name.

`text` is a string describing the purpose and function of the code model.

For example:

`NAME_TABLE :`

```
Spice_Model_Name: capacitor
C_Function_Name: cm_capacitor
Description: "Capacitor with voltage initial condition"
```

### 8.12.3.2 Port Table

The device ports are defined in the port tables. The port table has the following syntax:

PORT\_TABLE:

```
Port_Name:      name
Description:    text
Default_Type:   default
Allowed_Type:   [type type type]
Vector:         vector
Vector_Bounds: size
Direction:      dataflow
Null_Allowed:  null
```

where:

- name** is a valid SPICE identifier giving the name of the port.
- text** is a string describing the purpose and function of the port.
- default** specifies the type used for the port when no type is explicitly specified. Must be one of the items listed in "type".
- type** lists the allowed types to which the port can be connected, with names separated by commas or spaces (for example, [d, g, h]).

Type Name	Valid Directions	Description
d	in, out	digital
g	in, out	conductance (voltage input, current output)
gd	in, out	differential conductance (voltage input, current output)
h	in, out	resistance (current input, voltage output)
hd	in, out	differential resistance (current input, voltage output)
i	in, out	current
id	in, out	differential current
v	in, out	voltage
vd	in, out	differential voltage

	vnam	in	current through named voltage source
vector	specifies whether or not port is a vector and can be considered a bus. Choose from: <ul style="list-style-type: none"><li>• yes - this port is a vector</li><li>• no - this port is not a vector</li></ul>		
size	for port that are vectors only, specifies upper and lower bounds on vector size. Lower bound specifies minimum number of elements, upper bound specifies maximum number of elements. For unconstrained range, or ports that are not a vector, use a hyphen ("-").		
dataflo	specifies the dataflow direction through the port. Choose from:		
w	<ul style="list-style-type: none"><li>• in</li><li>• out</li><li>• inout</li></ul>		
null	specifies whether or not it is an error to leave the port unconnected. Choose from: <ul style="list-style-type: none"><li>• yes - this port may be left unconnected</li><li>• no - this port must be connected</li></ul>		

For example:

```
PORT_TABLE:
```

```
Port_Name:      cap
Description:    "capacitor terminals"
Direction:     inout
Default_Type:  hd
Allowed_Types: [hd]
Vector:        no
Vector_Bounds: -
Null_Allowed:  no
```

### 8.12.3.3 Parameter Table

The device parameters are defined in the parameter tables. The parameter table has the following syntax:

```
PARAMETER_TABLE:
```

```
Parameter_Name: name
Description:     text
Data_Type:      type
Vector:         vector
Vector_Bounds: size
Default_Value:  default
Limits:         range
Null_Allowed:  null
```

where:

- name is a valid SPICE identifier which will be used on SPICE deck .model cards to refer to this parameter.
- text is a string describing the purpose and function of the parameter.
- type is the parameter data type. Corresponds to the underlying C data type (e.g. "double"), not the conceptual type of the parameter (e.g. "voltage"). Choose from:
  - boolean (if C data type is "Boolean\_t" with valid values MIF\_TRUE and MIF\_FALSE)
  - complex (if C data type is "Complex\_t" with double members real and imag)
  - int (if C data type is "int")
  - real (if C data type is "double")
  - string (if C data type is "char\*")
  - pointer (if C data type is "void\*")
- vector: specifies whether parameter is vector or scalar. Choose from:
  - yes - parameter is vector
  - no - parameter is scalar
- size: for parameters that are vectors only, specifies upper and lower bounds on vector size. Lower bound specifies minimum number of elements, upper bound specifies maximum number of elements. For unconstrained range, or parameters that are not a vector, use a hyphen ("-"). Alternatively, specifies the name of the port whose vector size is to be used for this parameter.
- default if Null\_Allowed is "yes", a default value to be used if the SPICE deck .model line does not supply a value for the parameter. Value must correspond to Data\_Type (numeric, boolean, complex or string literal).
- range is a limited range of values (for "int" and "real" type parameters only).
- null specify whether or not parameter is allowed to be null. Choose from:
  - yes - the corresponding SPICE deck .model card may omit a value for this parameter, and the default value will be used or, if no default value, an undefined value will be passed to the code model
  - no - this parameter must have a value. XSPICE will flag an error if the corresponding SPICE deck .model card omits a value for this parameter.

For example:

PARAMETER\_TABLE:

Parameter_Name:	c	ic
Description:	"capacitance"	"voltage initial condition"
Data_Type:	real	real
Default_Value:	-	0.0
Limits:	-	-
Vector:	no	no
Vector_Bounds:	-	-
Null_Allowed:	no	no

### 8.12.3.4 Example Interface File

Here is an example interface file:

```
/* =====
FILE    ifspec.ifs
MEMBER OF process XSPICE
Copyright 1991
Georgia Tech Research Corporation
Atlanta, Georgia 30332
All Rights Reserved

PROJECT A-8503

AUTHORS
    9/12/91  Bill Kuhn

MODIFICATIONS
    <date> <person name> <nature of modifications>

SUMMARY
This file contains the definition of a capacitor code model with
voltage type initial conditions.

INTERFACES
None.

REFERENCED FILES
None.

NON-STANDARD FEATURES
None.
===== */

NAME_TABLE:

Spice_Model_Name:    capacitor
C_Function_Name:    cm_capacitor
Description:         "Capacitor with voltage initial condition"

PORT_TABLE:

Port_Name:          cap
Description:        "capacitor terminals"
Direction:          inout
```



```

Default_Type:      hd
Allowed_Types:    [hd]
Vector:           no
Vector_Bounds:    -
Null_Allowed:     no

```

PARAMETER\_TABLE:

```

Parameter_Name:   c                ic
Description:      "capacitance"    "voltage initial condition"
Data_Type:        real             real
Default_Value:    -                0.0
Limits:           -                -
Vector:           no               no
Vector_Bounds:    -                -
Null_Allowed:     no               no

```

## 8.12.4 The Implementation File (Cfunc.mod)

At each simulation iteration for a circuit using the code model, Multisim's XSpice simulation engine calls the implementation file. An example of an implementation file is shown in "8.12.4.2 Example Implementation File" on page 8-130. The implementation file, along with the interface file, needs to be coupled into a DLL to complete the code model.

The code model function then generates the code-modeled device's output. This output is based on the following:

- The input that XSpice presents to the code model function.
- The state of the model, which is stored and returned by XSpice.

The implementation file includes one or more of the macros, shown in "8.12.4.1 Implementation File C Macros" on page 8-122, that provide the API (Application Programming Interface) between XSpice and the code model.

This section lists the macros from which you can select. The example file shown in "8.12.4.2 Example Implementation File" on page 8-130 gives an example of how to implement a macro. The implementation file, along with the interface file, needs to be compiled into a DLL to complete the code model.

## 8.12.4.1 Implementation File C Macros

### AC\_GAIN(outputname, inputname)

<b>Type</b>	Complex_t
<b>Args</b>	y[i], x[i]
<b>Applies to</b>	Analog code models only (event-driven or digital code models should do nothing during AC analysis).
<b>Description</b>	Assigns a value to this macro to specify the gain from outputname to inputname at the current frequency. The code model function is called once for each frequency point simulated.

### ANALYSIS

<b>Type</b>	enum
<b>Args</b>	none
<b>Applies to</b>	All code models, since their behavior typically changes depending on the type of analysis being performed, and this macro can be used to specify appropriate output macros.
<b>Description</b>	Returns the type of analysis being performed: MIF_AC for AC MIF_DC for DC operating point MID_TRAN for transient

### ARGS

<b>Type</b>	Mif_Private_t
<b>Args</b>	none
<b>Applies to</b>	All code models.
<b>Description</b>	The code model function's parameter list. Must be present and should not be modified.

### CALL\_TYPE

<b>Type</b>	enum
<b>Args</b>	none
<b>Applies to</b>	Only code models that are mixed-mode (analog and event-driven or digital).
<b>Description</b>	If the analog portion of the simulator requested the code model call, set to MIF_ANALOG. If the digital portion of the simulator requested the code model call, set to MIF_EVENT. Needed if a code model's computation effort can be reduced based on the type of call made.

### INIT

<b>Type</b>	Boolean_t
<b>Args</b>	none
<b>Applies to</b>	All code models.
<b>Description</b>	If this is the first call to the code model function during the current analysis or batch of analyses, set to MIF_TRUE. Otherwise, set to MIF_FALSE. Needed to let the code model perform startup activities (for example, allocated memory) at the start of simulation only.

### INPUT(inputname)

<b>Type</b>	double or void *
<b>Args</b>	name [i]
<b>Applies to</b>	Analog/mixed-mode code models.
<b>Description</b>	Only analog inputs are allowed (for event-driven, use INPUT_STATE and INPUT_STRENGTH). Returns the value on the node or branch connected to inputname. Type/units of input value is specified when input type is specified in the lfspec.lfs file.

**INPUT\_STATE(inputname)**

<b>Type</b>	enum
<b>Args</b>	name [i]
<b>Applies to</b>	Digital/mixed-mode code models.
<b>Description</b>	Only event-driven/digital inputs are allowed (for analog, use INPUT). Returns the digital value (ZERO, ONE or UNKNOWN) at node at inputname. When a single output is connected to that node, this will equal the value of the last output event. When multiple outputs are connected, conflict resolution is performed.

**INPUT\_STRENGTH(inputname)**

<b>Type</b>	enum
<b>Args</b>	name [i]
<b>Applies to</b>	Digital/mixed-mode code models.
<b>Description</b>	Only event-driven/digital inputs are allowed (for analog, use INPUT). Returns the digital strength (STRONG, RESISTIVE, HI_IMPEDANCE or UNDETERMINED) of node at inputname. When a single output is connected to that node, this will equal the strength of the last output event. When multiple outputs are connected, conflict resolution is performed.

**INPUT\_TYPE(inputname)**

<b>Type</b>	char *
<b>Args</b>	name [i]
<b>Applies to</b>	All code models.
<b>Description</b>	Any inputs allowed. Returns the type string (i.e.: "v" for voltage, "i" for digital, "hd" for differential conductance, etc.) which describes the current usage of inputname. Needed to distinguish between "simulation time" usage of an input or output with more than one allowed type. For example, used for an input which has allowed types [v, i] and behaves differently when the input is voltage vs. current.

### LOAD(inputname)

<b>Type</b>	double
<b>Args</b>	name [i]
<b>Applies to</b>	Digital/mixed-mode code models.
<b>Description</b>	Only event-driven/digital inputs are allowed. Assign a value to LOAD to set the input load due to inputname on the connected node. The load is given as a capacitance (normalized to 1ohm resistance) which is summed with all the other loads on the event-driven node to yield the total delay of the node.

### MESSAGE(outputname)

<b>Type</b>	char *
<b>Args</b>	name [i]
<b>Applies to</b>	Digital/mixed-mode code models.
<b>Description</b>	Only event-driven/digital outputs are allowed. A message string to be placed on an event-driven node can be assigned to MESSAGE. Allows a code model to issue a message associated with a node.

### OUTPUT(outputname)

<b>Type</b>	double or void *
<b>Args</b>	name [i]
<b>Applies to</b>	Analog/mixed-mode code models.
<b>Description</b>	Only analog outputs are allowed (for event-driven, use OUTPUT_STATE and OUTPUT_STRENGTH and OUTPUT_DELAY). Assigns a value to the node or branch connected to outputname. Type/units of output value specified when output type is specified in the lfspec.lfs file.

**OUTPUT\_CHANGED(outputname)**

<b>Type</b>	Boolean_t
<b>Args</b>	name [i]
<b>Applies to</b>	Digital/mixed-mode code models.
<b>Description</b>	Only event-driven/digital inputs are allowed. Set to MIF_TRUE by default. Assign MIF_FALSE to indicate no change on that output. Allows the code model to specify that the event-driven output did not change and thereby speed up simulation.

**OUTPUT\_DELAY(outputname)**

<b>Type</b>	none
<b>Args</b>	double
<b>Applies to</b>	Digital/mixed-mode code models.
<b>Description</b>	Only event-driven/digital inputs are allowed (for analog, use OUTPUT). Sets the delay after which the transition event specified by OUTPUT_STATE occurs.

**OUTPUT\_STATE(outputname)**

<b>Type</b>	none
<b>Args</b>	Digital_State_t
<b>Applies to</b>	Digital/mixed-mode code models.
<b>Description</b>	Only event-driven/digital outputs are allowed (for analog, use OUTPUT). Assigns the digital value (ZERO, ONE or UNKNOWN) to node at outputname by creating an event which is a transition to that value. When a single output is connected to that node, this will equal the value of the last output event. When multiple outputs are connected, conflict resolution is performed.

### OUTPUT\_STRENGTH(outputname)

<b>Type</b>	none
<b>Args</b>	Digital_State_t
<b>Applies to</b>	Digital/mixed-mode code models.
<b>Description</b>	Only event-driven/digital outputs are allowed (for analog, use OUTPUT). Assigns the digital strength (STRONG, RESISTIVE, HI_IMPEDANCE or UNDETERMINED) at node at outputname. When a single output is connected to that node, this will equal the strength of the last output event. When multiple outputs are connected, conflict resolution is performed.

### OUTPUT\_TYPE(inputname)

<b>Type</b>	char *
<b>Args</b>	name [i]
<b>Applies to</b>	Digital/mixed-mode code models.
<b>Description</b>	Any output allowed. Returns the type string (i.e.: "v" for voltage, "i" for digital, "hd" for differential conductance, etc.) which describes the current usage of outputname. Needed to distinguish between "simulation time" usage of an input or output with more than one allowed type. For example, used for an input which has allowed types [v, i] and behaves differently when the input is voltage vs. current.

### PARAM(paramname)

<b>Type</b>	CD
<b>Args</b>	name [i]
<b>Applies to</b>	Any code model.
<b>Description</b>	Applies to all parameters. Returns the value paramname. Needed to access model parameters specified in the netlist.

**PARAM\_NULL(paramname)**

<b>Type</b>	Boolean_t
<b>Args</b>	name [i]
<b>Applies to</b>	Only parameters allowed to be unspecified (Null allowed in the param table of the Ifspec.Ifz file is yes).
<b>Description</b>	Returns MIF_TRUE if paramname was not specified in the netlist and MIF_FALSE if it was specified. Allows the code model to tell if a parameter value equals its default because the default value was actually specified.

**PARAM\_SIZE(paramname)**

<b>Type</b>	int
<b>Args</b>	name
<b>Applies to</b>	Vector type parameters only.
<b>Description</b>	Returns the number of elements in a vector type parameter. Needed to iterate over the vector parameter if the number of vector elements is not fixed.

**PARTIAL**

<b>Type</b>	double
<b>Args</b>	y[i], x[i]
<b>Applies to</b>	Analog/mixed-mode code models.
<b>Description</b>	Partial derivative of output y with respect to input x.



### PORT\_NULL

<b>Type</b>	Boolean_t
<b>Args</b>	name[i]
<b>Applies to</b>	Any code model.
<b>Description</b>	Has this port been specified as unconnected?

### PORT\_SIZE

<b>Type</b>	int
<b>Args</b>	name
<b>Applies to</b>	Any code model.
<b>Description</b>	Size of port vector.

### RAD\_FREQ

<b>Type</b>	double
<b>Args</b>	<none>
<b>Applies to</b>	Analog/mixed-mode code models.
<b>Description</b>	Current analysis frequency in radians per second.

### T (<n>)

<b>Type</b>	double
<b>Args</b>	<none>
<b>Applies to</b>	All code models.
<b>Description</b>	History of the previous nth analysis time (TIME = T[0]). Maximum of 8.

### TEMPERATURE

<b>Type</b>	double
<b>Args</b>	<none>
<b>Applies to</b>	All code models.
<b>Description</b>	Current analysis temperature.

### TIME

<b>Type</b>	double
<b>Args</b>	<none>
<b>Applies to</b>	All code models.
<b>Description</b>	Current analysis time (same as T[0]).

## 8.12.4.2 Example Implementation File

Here is an example implementation file:

```

/* =====
FILE      cfunc.mod

MEMBER OF process XSPICE

Copyright 1991
Georgia Tech Research Corporation
Atlanta, Georgia 30332
All Rights Reserved

PROJECT A-8503

AUTHORS
    9/12/91  Bill Kuhn

MODIFICATIONS
    <date> <person name> <nature of modifications>

SUMMARY
    This file contains the definition of a capacitor code model
    
```

with voltage type initial conditions.

```

INTERFACES
    cm_capacitor()

REFERENCED FILES
    None.

NON-STANDARD FEATURES
    None.

===== */

#define VC 0

void cm_capacitor (ARGS)
{
    Complex_t    ac_gain;
    double       partial;
    double       ramp_factor;
    double       *vc;

    /* Get the ramp factor from the .option ramptime */
    ramp_factor = cm_analog_ramp_factor(MIF_INSTANCE);

    /* Initialize/access instance specific storage for capacitor volt
age */
    if(INIT) {
        cm_analog_alloc(MIF_INSTANCE,VC, sizeof(double));
        vc = cm_analog_get_ptr(MIF_INSTANCE,VC, 0);
        *vc = PARAM(ic) * cm_analog_ramp_factor(MIF_INSTANCE);
    }
    else {
        vc = cm_analog_get_ptr(MIF_INSTANCE,VC, 0);
    }

    /* Compute the output */
    if(ANALYSIS == DC) {
        OUTPUT(cap) = PARAM(ic) * ramp_factor;
        PARTIAL(cap, cap) = 0.0;
    }
    else if(ANALYSIS == AC) {
        ac_gain.real = 0.0;
        ac_gain.imag = -1.0 / RAD_FREQ / PARAM(c);
    }
}

```

```
        AC_GAIN(cap, cap) = ac_gain;
    }
    else if(ANALYSIS == TRANSIENT) {
        if(ramp_factor < 1.0) {
            *vc = PARAM(ic) * ramp_factor;
            OUTPUT(cap) = *vc;
            PARTIAL(cap, cap) = 0.0;
        }
        else {
            cm_analog_integrate(MIF_INSTANCE, INPUT(cap) / PARAM(c),
                vc, &partial);
            partial /= PARAM(c);
            OUTPUT(cap) = *vc;
            PARTIAL(cap, cap) = partial;
        }
    }
}
```

# Chapter 9

## Simulation

This chapter explains the various types of simulation available in Multisim 9, the application for which each type is appropriate, how the types of simulation are used separately and together, and finally some of the underlying logic of Multisim 9 simulation.



Some of the features described in this chapter may not be available in your edition of Multisim 9. Such features have an icon in the column next to their description. Refer to the release notes for a list of the features in your edition.

The following are described in this chapter:

<b>Subject</b>	<b>Page No.</b>
<b>Introduction to Simulation</b>	9-2
<b>Using Multisim Simulation</b>	9-3
Start/Stop/Pause Simulation	9-4
Circuit Consistency Check	9-5
Simulation from Netlist Without Schematic	9-6
<b>Multisim SPICE Simulation: Technical Detail</b>	9-6
Circuit Simulation Mechanism	9-6
Four Stages of Circuit Simulation	9-7
Equation Formulation	9-9
Equation Solution	9-10
User Setting: Maximum Integration Order	9-10
Convergence Assistance Algorithms	9-11
Digital Simulation	9-11
<b>RF Simulation</b>	9-12
<b>MultiVHDL</b>	9-13

<b>Subject</b>	<b>Page No.</b>
<b>Circuit Wizards</b>	9-13
555 Timer Wizard	9-14
Filter Wizard	9-18
Common Emitter BJT Amplifier Wizard	9-19
MOSFET Amplifier Wizard	9-21
Opamp Wizard	9-22
<b>Simulation Error Log/Audit Trail</b>	9-25
<b>Simulation Adviser</b>	9-26
<b>Saving/Loading Simulation Profiles</b>	9-27
Saving a Simulation Profile	9-27
Loading a Simulation Profile	9-28
<b>Using Simulation for Better Designs</b>	9-28

## 9.1 Introduction to Simulation

Simulation is a mathematical way of emulating the behavior of a circuit. With simulation, you can determine much of a circuit's performance without physically constructing the circuit or using actual test instruments. Although Multisim makes simulation intuitively easy-to-use, the technology underlying the speed and accuracy of the simulation, as well as its ease-of-use, is complex.

Multisim incorporates SPICE3F5 and XSPICE at the core of its simulation engine, with customized enhancements designed by Electronics Workbench specifically for optimizing simulation performance with digital and mixed-mode simulation. Both SPICE3F5 and XSPICE are industry-accepted, public-domain standards. SPICE3F5 is the most recent edition of the SPICE (Simulation Program with Integrated Circuit Emphasis) core designed by the University of California at Berkeley. XSPICE is a set of unique enhancements made to SPICE, under contract to the US Air Force, which included event-driven mixed mode simulation, and an end-user extensible modelling subsystem. Electronics Workbench has further enhanced these cores with certain non-SPICE-standard PSPICE compatibility features to allow for using a wider range of off-the-shelf SPICE models.

Multisim's RF Design module simulates RF circuits using an optimized SPICE engine. There is no need to tell Multisim that your circuit is an RF circuit. RF simulation uses the SPICE simulation engine, but has been optimized to accurately simulate circuits designed to operate at higher frequencies. This optimization uses parts specifically designed and modeled to simulate accurately at these higher frequencies.

Purchased separately, MultiVHDL provides the capability to simulate components modeled in VHDL and adds to Multisim the ability to co-simulate VHDL-modeled parts alongside general mixed analog/digital parts. Use of the co-simulator is entirely transparent. If a schematic contains complex digital chips modeled with VHDL, the co-simulator is automatically and transparently invoked.

## 9.2 Using Multisim Simulation

To view the results of your simulation, you will need to use either a virtual instrument or run an analysis to display the simulation output. This output will include the combined results of all Multisim simulation engines.

When you use interactive simulation in Multisim (by clicking on the **Run Simulation** button), you see the simulation results instantly by viewing virtual instruments such as the oscilloscope. You can also view the effect of simulation on components like LED's and 7-segment digital displays.

During simulation, you can change the values of “interactive” components (those whose behavior can be controlled through the keyboard) and view the effect immediately. Interactive components include such devices as the potentiometer, variable capacitor, variable inductor, and multiple switcher. For example, changing a 100 kohm resistor to the next smaller resistor may alter the results more than desired, but with Multisim, you could use a variable resistor, reducing its value gradually, all the time seeing the simulation result change, until you reach the desired result.

As well as interactive simulation, you can run numerous analyses on your circuits. Results of analyses are displayed in the **Grapher** and can also be saved for later manipulation in the **Postprocessor**. For details, see “11.2 Viewing the Analysis Results: Grapher” on page 11-4 and “12.1 Introduction to the Postprocessor” on page 12-2.

**Note** All simulations require a reference net with respect to which all voltages are given. In SPICE, this is always net 0. Therefore, somewhere in the circuit a net named "0" must be defined. One may either name a net 0, or this will happen automatically if a ground component is wired into a circuit. This is illustrated below.

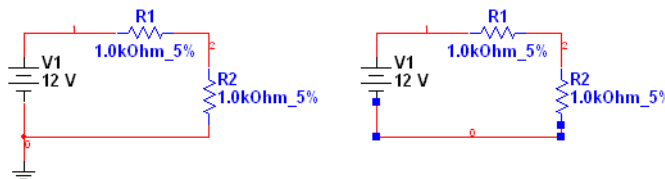

## 9.2.1 Start/Stop/Pause Simulation



- To simulate a circuit, click the **Run/stop simulation** button. Multisim begins to simulate the circuit's behavior. You can also select **Simulate/Run**.

**Note** When simulating a design that contains hierarchical blocks, subcircuits and/or multi-pages, the entire design is simulated, not just the current sheet. To simulate a hierarchical block in isolation, you must open that block as a new design by selecting **File/Open**. Subcircuits cannot be simulated by themselves.

During simulation, messages about the simulation results and any problems with the simulation are written to the simulation error log/audit trail. If you want to keep an eye on the progress of the simulation, you can display the error log/audit trail during simulation. To display it, choose **Simulate/Simulation Error Log/Audit Trail**.

- To pause the simulation while it is running, select **Simulate/Pause**. To resume the simulation from the same point as when you paused, select **Simulate/Pause** again.
- To stop a simulation, click the **Run/stop simulation** button or select **Simulate/Run**. If you restart the simulation after stopping it, it will restart from the beginning (unlike **Pause**, which allows you to restart from the point where you paused).

**Note** Before running your simulation, you have the option to perform an electrical rules check. For details, see “5.4 Electrical Rules Checking” on page 5-34.

### 9.2.1.1 Simulation Running Indicator

To indicate that a simulation is running, the **Simulation Running Indicator** appears in the status bar as in the example below. This indicator flashes until you stop the simulation. This is especially useful when viewing an instrument that has reached a steady state, such as the **IV Analyzer**.



### 9.2.1.2 Simulation Speed

There are many parameters that affect simulation speed and convergence. These are accessible from the **Interactive Simulation Settings** dialog box (see “10.3 Interactive



Simulation Settings” on page 10-8). Some of the most important settings are shown on the first tab.

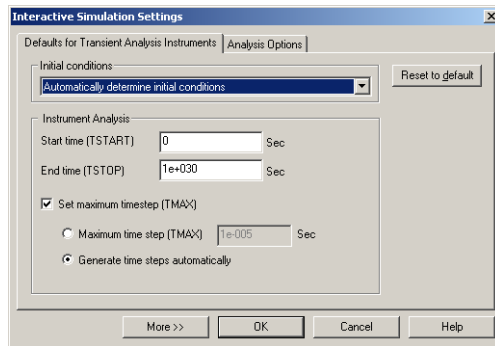

The most important simulation setting governing speed of simulation is the setting of TMax. TMax is the maximum time step that the simulator is allowed to take. In order to produce results, the simulator may take smaller time steps at its discretion, however it will never take a larger step than that specified by TMax. The smaller TMax is, the more accurate the simulation results will be. However it will take longer to reach any given simulation results.

In general, most simulations will run slower than real-time. However, if a lot of time resolution is not required, or if the circuit is primarily digital (in which case time steps will always be inserted where digital events occur and hence TMax may be set large) then TMax may be set to a higher value. If this results in the simulation running faster than real-time, it is artificially slowed down to real-time and your CPU is freed up for other tasks.

If "automatically determine" is chosen, then TMax will be set in accordance with the highest frequency AC power source in the schematic, or to the smallest resolution instrument.

## 9.2.2 Circuit Consistency Check

When you simulate your circuit or perform an analysis, a circuit consistency check is performed to determine if the circuit obeys the simulation rules — for example, if a ground is present. Errors are written to the error log. This function speeds your simulation process, since it alerts you to items that may cause simulation errors and allows you to correct them before simulating.

## 9.2.3 Simulation from Netlist Without Schematic



You can also run simulations from a command line.

- To open the command line interface, choose **Simulate/Xspice Command Line Interface**. The **XSpice Command Line** dialog box appears.

You can enter netlists and commands directly in this dialog box. The most important commands are: SOURCE, PLOT, OP, SAVE, WRITE, TAN, SET and ANAC.

## 9.3 Multisim SPICE Simulation: Technical Detail

This section explains the basic technical methodology of circuit simulation in a SPICE-based simulator, including an outline of the stages of circuit simulation and an explanation of the methods of formulation and solution used in the circuit simulation. It is not necessary to fully understand this information to make use of Multisim's simulation, but you may find it interesting.

To fully understand the information in this section, you should be acquainted with the theory of electronic circuit simulation and the mathematics involved.

### 9.3.1 Circuit Simulation Mechanism

After you create a circuit schematic and begin simulation, the solution of the circuit and generation of the data you see on instruments such as the oscilloscope is the role of the simulator. More specifically, the simulator is the part of Multisim that calculates a numerical solution to a mathematical representation of the circuit you created.

For this calculation to occur, each component in a circuit is represented by a mathematical model. Mathematical models link the schematic in the circuit window with the mathematical representation for simulation. The accuracy of the component models is one of the key items that determines the degree to which simulation results match real-world circuit performance.

The mathematical representation of a circuit is a set of simultaneous, nonlinear differential equations. The main task of the simulator is to solve these equations numerically. A SPICE-based simulator transforms the nonlinear differential equations into a set of nonlinear algebraic equations. These equations are further linearized using the modified Newton-Raphson method. The resulting set of linear algebraic equations is efficiently solved using the sparse matrix processing LU factorization method.

## 9.3.2 Four Stages of Circuit Simulation

The simulator in Multisim has four main stages: input, setup, analysis and output (described below).

Stage	Description
Input stage	Simulator reads information about your circuit (after you have built a schematic, assigned values and chosen an analysis). This is the process of netlist generation.
Setup stage	Simulator constructs and checks a set of data structures that contain a complete description of your circuit.
Analysis stage	The circuit analysis specified in the input stage is performed. This stage occupies most of the CPU execution time and is actually the core of circuit simulation. The analysis stage formulates and solves circuit equations for the specified analyses and provides all the data for direct output or postprocessing.
Output stage	You view the simulation results. You can view results on instruments such as the oscilloscope, on graphs that appear when you run an analysis, or in the log file/audit trail.

SPICE-based simulation works by first converting a schematic into a SPICE netlist. Multisim performs this awkward and time-consuming task automatically whenever required. SPICE models are stored in Multisim's extensive parts database. These models are SPICE netlist

templates stored in the database. During netlist generation, these templates are expanded for use in the generated SPICE netlist.

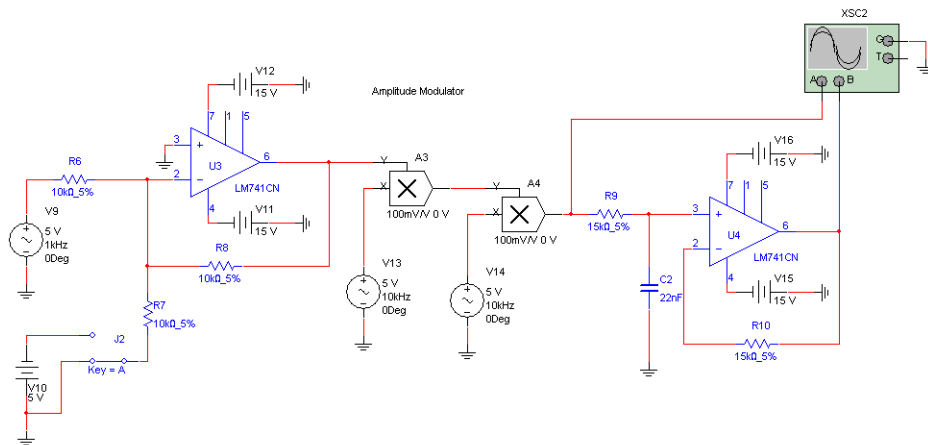

```

rR5 15 16 1.500e+004
rR4 13 14 1.500e+004
cC1 14 0 2.2E-8
UU8 0 11 dc 15 ac 0 0
+      distof1 0 0
+      distof2 0 0
UU7 0 12 dc 15 ac 0 0
+      distof1 0 0
+      distof2 0 0
xU2 14 15 16 LM741_OPAMP_1
xU1 0 4 5 LM741_OPAMP_1
aA2 [9 10] 13 MultiplierA2
.model MultiplierA2 mult(
+ out_gain=0.1
+ out_offset=0
+ in_offset=[0 0]
+ in_gain=[1 1])

```

The text above is a small part of the netlist that Multisim generates for the Amplitude Modulator circuit shown above. This netlist is the actual input to SPICE required to perform the simulation.

Prior to schematic entry programs such as Multisim, designers were required to tediously create such SPICE netlists for themselves each time they wished to analyze a circuit. A modern schematic capture tool, in addition to providing a front-end for PCB layout or other downstream activities such as IC or FPGA design, does this time-consuming and error-prone task automatically.

From the netlist, SPICE generates matrices that it solves numerically to come up with voltages (AC and DC) at every node in the circuit. Current *branches* also appear in the matrices when required in order to solve the equations. In particular, current branches appear

whenever voltage sources are used (SPICE trick: if you need to measure a current in SPICE, insert a 0V voltage source. It will not affect the circuit but will force SPICE to compute the current running through the 0V source).

For a transient analysis (which is also the basis for interactive simulation), the matrices are solved at every time step in the simulation. Because non-linear analog parts are present in the simulation, at each time step successive approximations are used to compute the final node voltage results. It is possible under certain circumstances that these results do not converge. When this happens, SPICE backs up to 1/8th the time step used previously and tries again.

### 9.3.3 Equation Formulation

In a circuit, each common point created by wires and connectors is called a node. The simulator calculates the voltage at each node. Each branch joining two nodes will have a separate current flowing through it.

To calculate a circuit solution, a circuit is represented internally as a system of equations, in the form:

$$A * X = B$$

where:

- A = modified nodal admittance matrix with dimension  $n \times n$
- X = vector of unknowns with dimension  $n$
- B = vector of constants, also with dimension  $n$
- n = number of unknowns.

The system of equations is formulated using a general circuit analysis method called the Modified Nodal Approach (MNA).

The unknowns ( $n$ ) include each node voltage (excluding ground), as well as the voltage source currents. B contains the voltage and current source constants, and the entries in the admittance matrix (A) are determined by Ohm's law and Kirchhoff's current and voltage laws.

The modified nodal admittance matrix is deemed sparse because it contains more zeros than non-zeros. Making use of a linked list, the solution of circuit equations can be performed by employing non-zero terms only. This method is called Sparse Matrix Technique. Generally, a sparse matrix approach requires less memory consumption and achieves faster simulation.

## 9.3.4 Equation Solution

Multisim solves circuit equations for linear and nonlinear circuits using a unified algorithm. The solution of a linear DC circuit is treated as a special case of general nonlinear DC circuits.

LU factorization is used to solve the system of sparse modified nodal matrix equations described previously (a set of simultaneous linear equations). This involves decomposing the matrix  $A$  into two triangular matrices (a lower triangular matrix,  $L$ , and an upper triangular matrix,  $U$ ) and solving the two matrix equations using a forward substitution and a backward substitution.

Several efficient algorithms are used to avoid numerical difficulties due to the modified nodal formulation, to improve numerical calculation accuracy and to maximize the solution efficiency. These include:

- A partial pivot algorithm that reduces the round-off error incurred by the LU factorization method.
- A reordering algorithm that improves the matrix condition.
- A reordering algorithm that minimizes nonzero terms for the equation solution.

A nonlinear circuit is solved by transforming it into a linearized equivalent circuit at each iteration and iteratively solving the linear circuit using the above-described method.

Nonlinear circuits are transformed into linear ones by linearizing all nonlinear components in the circuit using the modified Newton-Raphson method.

A general nonlinear dynamic circuit is solved by transforming the circuit into a discretized equivalent nonlinear circuit at each time point and solving it using the method for a nonlinear DC circuit described above. A dynamic circuit is transformed into a DC circuit by discretizing all dynamic components in the circuit using an appropriate numerical integration rule.

## 9.3.5 User Setting: Maximum Integration Order

You can change the maximum order for integration method using the MAXORD analysis option (see “11.23 Analysis Options dialog box” on page 11-129). Using a higher order (3 through 6) Gear method theoretically leads to more accurate results, but slows down the simulation. Be aware that the maximum order for integration method is the maximum order that could be used, but that the simulator selects the most appropriate order based on the circuit.

Due to the nature of the nonlinear components, each time point may involve solving the admittance matrix several times before converging to a solution. The point solution is reached when the difference between consecutive voltage values is less than the tolerance calculated internally in terms of the absolute and relative tolerances specified in the analysis options.

## 9.3.6 Convergence Assistance Algorithms

Multisim uses two modified Newton-Raphson continuation algorithms, Gmin stepping and Source stepping, to help find the solution during a DC Operating Point analysis of general nonlinear circuits.

### 9.3.6.1 Gmin Stepping

Gmin stepping is a multi-step iterative algorithm. This algorithm simply adds a conductance, Gmin, to the diagonal elements of the modified nodal admittance matrix so that a solution will converge more quickly. The basic concept is to keep the matrix well-conditioned.

Initially, a large Gmin value is applied and an approximate solution is found quickly. The initial value is set by the Gmin value times  $10^{\text{GminSteps}}$  Gmin. The Gmin value is taken from the GMIN (Gmin Minimum Conductance) analysis option and the number of steps from GMINSTEPS (both options are described in more detail in “11.23 Analysis Options dialog box” on page 11-129). The conductance is then reduced by a factor of ten and the circuit is solved again by setting the previous solution as the initial guess of the next iteration. When Gmin is reduced to zero, a final solution of the circuit is performed and the correct answer is obtained. This actually divides one single-step solution of the simple nonlinear iteration into a multi-step solution, which uses the same algorithm but has many smaller steps.

### 9.3.6.2 Source Stepping

Source stepping is a convergence assistance algorithm. This algorithm solves a nonlinear circuit problem by setting a fraction of the source vector as a parameter variable to aid the convergence of the DC solution. Similar to the Gmin stepping method, Source stepping converts a single nonlinear circuit problem into a multi-step nonlinear circuit problem. Starting from a zero source vector, the source vector is slowly ramped up to its full DC value. At each source step, a simple nonlinear iteration solution is performed. The ramp rate is controlled by the SRCSTEPS (“Steps in source stepping algorithm”) analysis option (see “11.23 Analysis Options dialog box” on page 11-129).

## 9.3.7 Digital Simulation

Digital parts are modeled differently than analog parts. Digital parts are connected to the analog parts of the circuit using special XSPICE code models for A-to-D and D-to-A bridges. These models transform voltages into digital events and vice-versa. Thus a net in a schematic may be either analog or digital, but not both at once. When digital parts are connected to one another, the digital events propagate from one to the other with the appropriate simulated time delays. Time steps are automatically inserted into the simulation whenever digital events

make their presence felt on the analog parts of the circuit. This event-driven simulation approach to digital simulation allows these types of simulation to run much more quickly than analog simulations (hint: set the simulation parameter Tmax, the maximum analog time step, quite high for digital simulations in order to speed things up dramatically).

When simulating circuits with digital components, you have the option of simulating for speed or for accuracy. The “Ideal” option simulates your circuit quickly by not taking into account variances in digital power and internal tolerances. The time to simulate digital components is faster but the signal is not as accurate.

The “Real” option simulates your circuit accurately, but slower than the “Ideal” option, by accounting for all variances. When using “Real” simulation settings, you are required to add digital power and digital ground to your circuit.

➤ To select a digital simulation option:

1. Choose **Simulate/Digital Simulation Settings**.

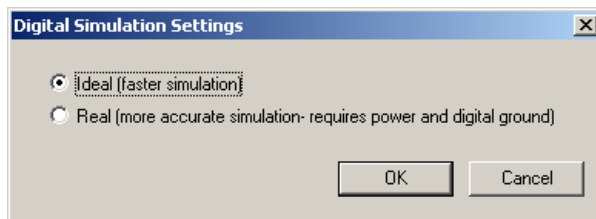

2. Select one of:

- **Ideal** — In this mode, if two digital pins are connected to one another, no additional circuitry is supplied. If a digital pin is attached to an analog node, a simplified pin driver circuit and A-to-D or D-to-A bridge is added into the netlist to smooth the edges of the abrupt digital transitions.
- **Real** — In this mode, all digital pins are attached to D-to-A or A-to-D converters, and more complex pin drivers better representing actual digital pin drivers are inserted into the netlist.

**Note** “Real” mode provides for more accurate voltage results, but “Ideal” mode runs faster. This switch only affects circuits that contain digital parts.

3. Click **OK**.

## 9.4 RF Simulation



RF simulation is included with Multisim Power Professional and is available as part of the Professional Edition in an optional RF Design module. This section contains a brief introduction to the simulation portion of the RF Design module.



You simulate an RF circuit the same way you simulate a board/system-level circuit in Multisim, as described in “9.2 Using Multisim Simulation” on page 9-3. This is because Multisim’s RF Design module simulates RF circuits using an optimized SPICE engine (as opposed to VHDL, etc.). There is no need to tell Multisim that your circuit is an RF circuit. RF simulation uses the SPICE simulation engine, but has been optimized to accurately simulate circuits designed to operate at higher frequencies, or at faster clock speeds (which generate RF characteristics). This optimization uses parts specifically designed and modeled to simulate accurately at these higher frequencies.

For detailed information on RF simulation and the RF Design module, see Chapter 15, “RF”.

## 9.5 MultiVHDL



VHDL (Very High Speed Integrated Circuit (VHSIC) Hardware Description Language) is designed to describe the behavior of complex digital devices. For this reason it is referred to as a “behavioral level” language; it can use behavioral level models (instead of transistor/gate level, like SPICE) to describe the behavior of these devices. Using VHDL avoids the unwieldy task of describing such devices at the gate level, greatly simplifying the design process.

MultiVHDL, Electronics Workbench’s VHDL simulator can be used in two ways:

- As part of the board/system design process, when components are modeled in VHDL instead of SPICE. Multisim automatically invokes the VHDL simulator as needed (this is called co-simulation). In this method, you do not need extensive VHDL knowledge, but can simply take advantage of the broader database of simulatable models for complex digital chips.
- As a VHDL source code editor/simulator, for writing and debugging VHDL source code.

For details, refer to the user documentation that comes with your MultiVHDL product.

## 9.6 Circuit Wizards

Multisim’s circuit wizards let you generate circuits that contain a schematic diagram, simulation models and a netlist. You simply enter the design parameters in a wizard’s dialog box and click a button to build the circuit. Once you have built the circuit, it can be simulated in the usual manner. The wizards that are available are:

- “9.6.1 555 Timer Wizard” on page 9-14
- “9.6.2 Filter Wizard” on page 9-18
- “9.6.3 Common Emitter BJT Amplifier Wizard” on page 9-19
- “9.6.4 MOSFET Amplifier Wizard” on page 9-21
- “9.6.5 Opamp Wizard” on page 9-22

## 9.6.1 555 Timer Wizard



Use the **555 Timer Wizard** to build astable and monostable oscillator circuits that use the 555 timer.

- **Astable Operation**—produces a free-running oscillator that does not need any input signal.
- **Monostable Operation**—produces a single output pulse in response to an input trigger pulse. When an input signal is applied, each input pulse will produce one output pulse.

➤ To build an astable oscillator:

1. Select **Tools/Circuit Wizards/555 Timer Wizard**. The **555 Timer Wizard** dialog box appears.
2. Select **Astable Operation** from the **Type** drop-down list.

Default settings are initially displayed. Refer to the schematic on the right of this dialog box for the location of these components in the circuit.

Click this button at any time to return to the default settings.

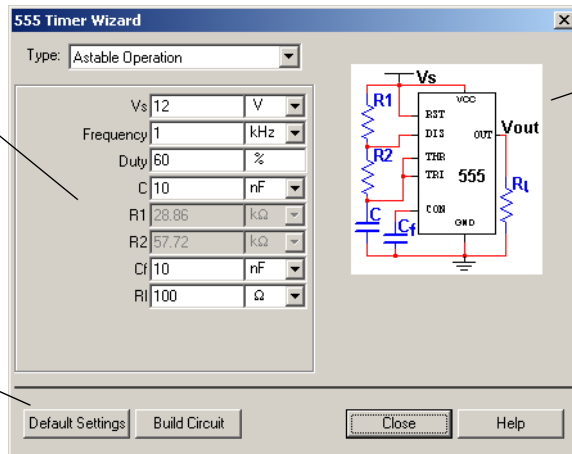

Circuit schematic.

3. Enter values based on the following:

**Vs**—Enter desired source voltage.

**Frequency**—Enter the frequency at which you wish the circuit to oscillate, to a maximum of 1 MHz.

**Duty**—Enter the duty cycle for the circuit. For example, 60% indicates that the circuit will be “on” for 60% of each cycle. Value must be greater than or equal to 50% and less than 100%.

**C**—This is the value of capacitor C and is initially set to 10 nF.

**Cf**—This is the value of capacitor Cf and is normally fixed to be 10 nF.

**Rl**—Enter desired load resistance.

4. As values are entered, R1 and R2 are calculated automatically and changed based on the following:
- $$R2 = (1-d)/(0.693*f*C)$$
- If  $d = 0.5$ ,  $R1 = R2/80$ , otherwise,  $R1 = (2*d-1)*R2/(1-d)$
- where  $d$  is the duty cycle,  $f$  is the oscillation frequency and  $C$  is the value of capacitor  $C$ .
5. If  $(R1+R2) > 3.3 \text{ Mohm}$  or  $R1 < 1 \text{ kohm}$  or  $R2 < 1 \text{ kohm}$ , a warning message displays on the **555 Timer Wizard** dialog box:

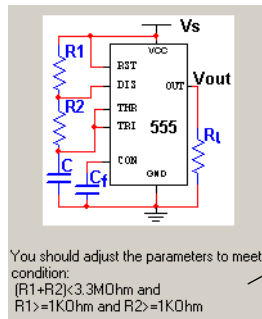

Warning Message

If this happens, change the value of capacitor  $C$  and other parameters until the error message no longer displays.

6. Check the values of  $R1$  and  $R2$ . If they are unavailable or unsatisfactory, change the value of capacitor  $C$ .
7. Repeat the above two steps until  $R1$  and  $R2$  are satisfactory and there is no error message on the **555 Timer Wizard** dialog box.

- Click on the **Build Circuit** button. The circuit, with the calculated values is placed on your workspace.

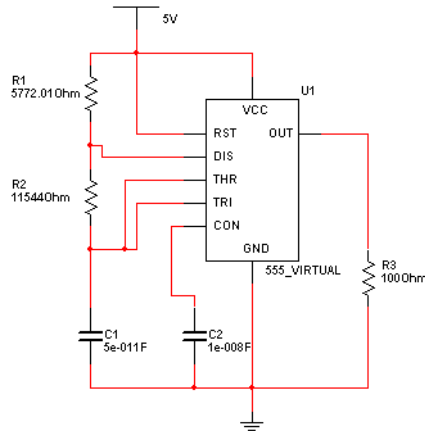

RefDes's of placed components follow circuit's numbering scheme.

- To build a monostable (one-shot) oscillator:
  - Select **Tools/Circuit Wizards/555 Timer Wizard**. The **555 Timer Wizard** dialog box appears.
  - Select **Monostable Operation** from the **Type** drop-down list.

Default settings are initially displayed. Refer to the schematic on the right of this dialog box for the location of these components in the circuit.

Click this button at any time to return to the default settings.

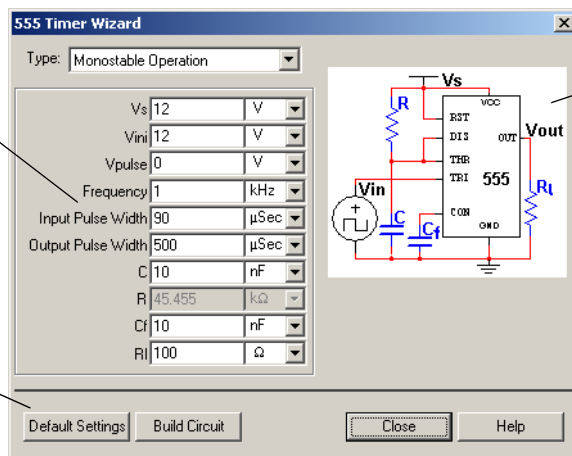

Circuit schematic.

- Enter values based on the following:
  - Vs**—Enter desired source voltage.
  - Vini**—Set equal to Vs.

**Vpulse**—Enter desired voltage of input pulse. This should be less than  $V_s/3$ .

**Frequency**—Enter the frequency of the input voltage.

**Output Pulse Width**—Enter desired output pulse width.

**Pulse Width**—Enter desired input pulse width. Must be less than Output Pulse Width/5. If it is not, the value in the **Output Pulse Width** field is changed by the system.

**C**—This is the value of capacitor C and is initially set to 1  $\mu$ F.

**Cf**—This is the value of capacitor Cf and is normally fixed to be 1 nF.

**RI**—Enter desired load resistance.

- As values are entered, R is calculated automatically and changed based on the following:

$$R = OW / (1.1 * C)$$

where OW is the output pulse width and C is the value of capacitor C.

- Check the value of R. If it is unavailable or unsatisfactory, change the value of capacitor C or other parameters until a satisfactory value is reached.
- Click on the **Build Circuit** button.
- The circuit, with the calculated values is placed on your workspace.

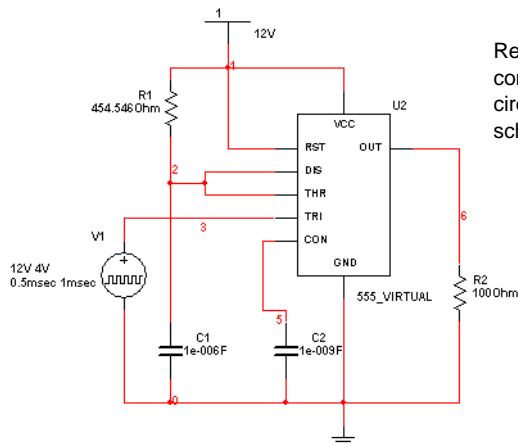

RefDes's of placed components follow circuit's numbering scheme.

## 9.6.2 Filter Wizard



The Multisim **Filter Wizard** lets you design numerous types of filters by entering the specifications into its fields. The designed circuit can then be verified by SPICE simulation directly.

- To design a filter using the **Filter Wizard**:

1. Select **Tools/Circuit Wizards/Filter Wizard**.

Available parameters change to match filter selected in Type drop-down list and the options selected in the Type, Topology, Source Impedance and Pass Band Ripple boxes

Parameters of filter selected in the Type drop-down list

2. Select the desired filter type from the **Type** drop-down list. Choices are low pass, high pass, band pass or band reject. The parameters that are available in the box below the **Type** drop-down and the diagram on the right of the dialog box change based on the selected filter type and the selections made in the following steps.
3. Select either **Butterworth** or **Chebyshev** in the **Type** box. If you select **Chebyshev**, the **Pass Band Ripple** box displays. If you select **Butterworth**, it does not.
4. Select either **Passive** or **Active** in the **Topology** box. If you select **Passive**, the **Source Impedance** box displays. If you select **Active**, it does not.
5. Select the desired source impedance in the **Source Impedance** box (for passive filters only).
6. Select the desired ripple in the **Pass Band Ripple** box (for Chebyshev type filters only).
7. Enter desired filter parameters in the box below the **Type** drop-down list.

**Note** The available parameters change depending on the selections made in the above steps.

8. Click **Verify**. If there are any problems with your design, a message displays below the diagram in the **Filter Wizard** dialog box. Adjust your parameters and click **Verify** again. When your design is error-free, the following message displays and the **Build Circuit** button becomes active:

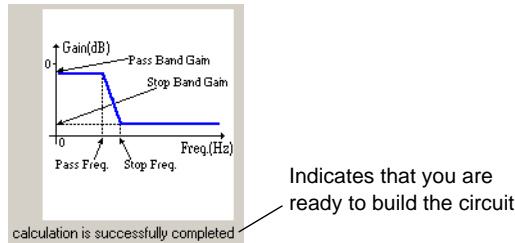

9. Click **Build Circuit**. The **Filter Wizard** dialog box closes and a “ghost” image of the circuit is placed on your cursor.
10. Move the cursor to the desired location and click the mouse to place the circuit.

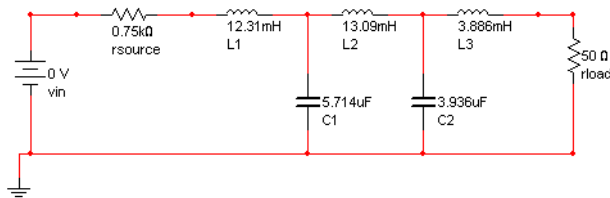

### 9.6.3 Common Emitter BJT Amplifier Wizard



The Multisim **Common Emitter BJT Amplifier Wizard** lets you design common emitter amplifier circuits by entering the desired specifications into its fields. The designed circuit can then be verified by SPICE simulation directly.

- To design a common emitter amplifier using the **Common Emitter BJT Amplifier Wizard**:
1. Select **Tools/Circuit Wizards/CE BJT Amplifier Wizard**. The following dialog box displays.

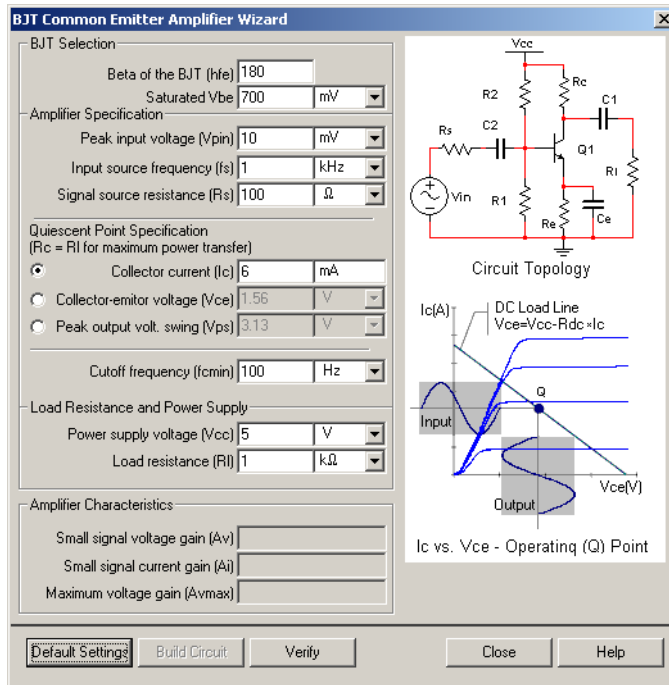

2. Enter the desired parameters in the **BJT Selection**, **Amplifier Specification**, **Quiescent Point Specification**, and **Load Resistance and Power Supply** boxes.
3. Click **Verify**. If there are any problems with your design, a message displays. Adjust your parameters and click **Verify** again.
4. Click **Build Circuit**. The **BJT Common Emitter Amplifier Wizard** dialog box closes and a “ghost” image of the circuit is placed on your cursor.



5. Move the cursor to the desired location and click the mouse to place the circuit.

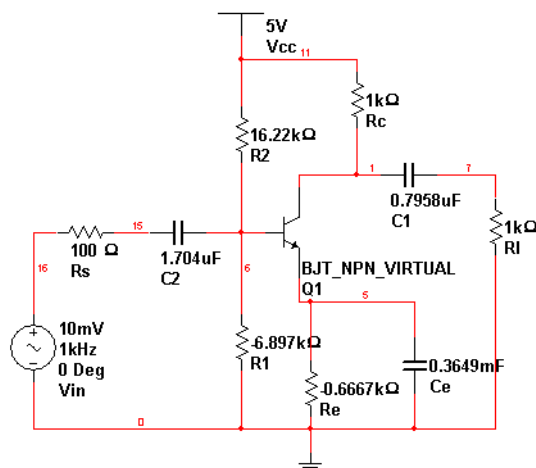

## 9.6.4 MOSFET Amplifier Wizard



The Multisim **MOSFET Amplifier Wizard** lets you design MOSFET amplifier circuits by entering the desired specifications into its fields. The designed circuit can then be verified by SPICE simulation directly.

- To design a MOSFET amplifier using the **MOSFET Amplifier Wizard**:
  1. Select **Tools/Circuit Wizards/MOSFET Amplifier Wizard**. The **MOSFET Amplifier Circuit Wizard** dialog box appears.
  2. Enter the desired parameters in the **MOSFET Selection**, **Amplifier Specification**, **Quiescent Point Specification**, and **Load Resistance and Power Supply** boxes.
  3. Click **Verify**. If a warning message displays, you may wish to adjust your parameters and click **Verify** again.
  4. Click **Build Circuit**. The **MOSFET Amplifier Circuit Wizard** dialog box closes and a “ghost” image of the circuit is placed on your cursor.
  5. Move the cursor to the desired location and click the mouse to place the circuit.

## 9.6.5 Opamp Wizard



The Multisim **Opamp Wizard** lets you design the following opamp circuits by entering the desired specifications into its fields:

- Inverting Amplifier
- Non-inverting Amplifier
- Difference Amplifier
- Inverted Summing Amplifier
- Non-inverted Summing Amplifier
- Scaling Adder.

The designed circuit can then be verified by SPICE simulation directly.

**Tip** When working in the Opamp Wizard, you can return to the default settings at any time by clicking the **Default Settings** button.

- To build an inverting amplifier:
  1. Select **Tools/Circuit Wizards/Opamp Wizard** to display the **Opamp Wizard** dialog box.
  2. Select “Inverting Amplifier” from the **Type** drop-down list. The contents of the dialog box change to reflect the selection.
  3. If you do not wish to include a source in the circuit, de-select the **Add Source** checkbox.
  4. In the **Input Signal Parameters** box, set the desired **Input Voltage** and **Input Frequency**.
  5. In the **Amplifier Parameters** box, set the desired **Voltage Gain**, **Input Impedance**, **Positive Rail Voltage** and **Negative Rail Voltage**.
  6. Click **Verify**. If a warning message displays, you may wish to adjust your parameters and click **Verify** again.
  7. Click **Build Circuit**. The **Opamp Wizard** dialog box closes and a “ghost” image of the circuit is placed on your cursor.
  8. Move the cursor to the desired location and click the mouse to place the circuit.
- To build a non-inverting amplifier:
  1. Select **Tools/Circuit Wizards/Opamp Wizard** to display the **Opamp Wizard** dialog box.
  2. Select “Non-Inverting Amplifier” from the **Type** drop-down list. The contents of the dialog box change to reflect the selection.
  3. If you do not wish to include a source in the circuit, de-select the **Add Source** checkbox.
  4. In the **Input Signal Parameters** box, set the desired **Input Voltage** and **Input Frequency**.
  5. In the **Amplifier Parameters** box, set the desired **Voltage Gain**, **Terminal Input Impedance**, **Feedback Resistor Value**, **Positive Rail Voltage** and **Negative Rail Voltage**.

6. Click **Verify**. If a warning message displays, you may wish to adjust your parameters and click **Verify** again.
  7. Click **Build Circuit**. The **Opamp Wizard** dialog box closes and a “ghost” image of the circuit is placed on your cursor.
  8. Move the cursor to the desired location and click the mouse to place the circuit.
- To build a difference amplifier:
1. Select **Tools/Circuit Wizards/Opamp Wizard** to display the **Opamp Wizard** dialog box.
  2. Select “Difference Amplifier” from the **Type** drop-down list. The contents of the dialog box change to reflect the selection.
  3. If you do not wish to include a source in the circuit, de-select the **Add Source** checkbox.
  4. In the **Input Signal Parameters** box, set the desired **Inverting Input Voltage**, **Inverting Input Frequency**, **Non-Inverting Input Voltage** and **Non-Inverting Input Frequency**.
  5. In the **Amplifier Parameters** box, set the desired **Inverting Voltage Gain**, **Non-Inverting Voltage Gain**, **Inverting Input Resistor Value**, **Non-Inverting Input Resistor Value**, **Positive Rail Voltage** and **Negative Rail Voltage**.
  6. Click **Verify**. If a warning message displays, you may wish to adjust your parameters and click **Verify** again.
  7. Click **Build Circuit**. The **Opamp Wizard** dialog box closes and a “ghost” image of the circuit is placed on your cursor.
  8. Move the cursor to the desired location and click the mouse to place the circuit.
- To build an inverting summing amplifier:
1. Select **Tools/Circuit Wizards/Opamp Wizard** to display the **Opamp Wizard** dialog box.
  2. Select “Summing Amplifier Inv” from the **Type** drop-down list. The contents of the dialog box change to reflect the selection.
  3. If you do not wish to include a source in the circuit, de-select the **Add Source** checkbox.
  4. Change the **Number of Inputs** as desired. Available inputs in the **Input Signal Parameters** box change accordingly.
  5. In the **Input Signal Parameters** box, set the **Input Voltage** and **Input Frequency** values for each active input (e.g., Input 1, Input 2, etc.).
  6. In the **Amplifier Parameters** box, set the desired **Voltage Gain**, **Feedback Resistor Value**, **Positive Rail Voltage** and **Negative Rail Voltage**.
  7. Click **Verify**. If a warning message displays, you may wish to adjust your parameters and click **Verify** again.
  8. Click **Build Circuit**. The **Opamp Wizard** dialog box closes and a “ghost” image of the circuit is placed on your cursor.

9. Move the cursor to the desired location and click the mouse to place the circuit.
- To build a non-inverting summing amplifier:
1. Select **Tools/Circuit Wizards/Opamp Wizard** to display the **Opamp Wizard** dialog box.
  2. Select “Summing Amplifier Non-Inv” from the **Type** drop-down list. The contents of the dialog box change to reflect the selection.
  3. If you do not wish to include a source in the circuit, de-select the **Add Source** checkbox.
  4. Change the **Number of Inputs** as desired. Available inputs in the **Input Signal Parameters** box change accordingly.
  5. In the **Input Signal Parameters** box, set the **Input Voltage** and **Input Frequency** values for each active input (e.g., Input 1, Input 2, etc.).
  6. In the **Amplifier Parameters** box, set the desired **Voltage Gain**, **Feedback Resistor Value**, **Positive Rail Voltage** and **Negative Rail Voltage**.
  7. Click **Verify**. If a warning message displays, you may wish to adjust your parameters and click **Verify** again.
  8. Click **Build Circuit**. The **Opamp Wizard** dialog box closes and a “ghost” image of the circuit is placed on your cursor.
  9. Move the cursor to the desired location and click the mouse to place the circuit.
- To build a scaling adder:
1. Select **Tools/Circuit Wizards/Opamp Wizard** to display the **Opamp Wizard** dialog box.
  2. Select “Scaling Adder” from the **Type** drop-down list. The contents of the dialog box change to reflect the selection.
  3. If you do not wish to include a source in the circuit, de-select the **Add Source** checkbox.
  4. Change the **Number of Inputs** as desired. Available inputs in the **Input Signal Parameters** and **Amplifier Parameters** boxes change accordingly.
  5. In the **Input Signal Parameters** box, set the **Input Voltage** and **Input Frequency** values for each active input (e.g., Input 1, Input 2, etc.).
  6. In the **Amplifier Parameters** box, set the desired **Feedback Resistor Value**, **Positive Rail Voltage**, **Negative Rail Voltage** and the **Input Resistor Value** for each active input (**Input 1**, **Input 2**, etc).
  7. Click **Verify**. If a warning message displays, you may wish to adjust your parameters and click **Verify** again.
  8. Click **Build Circuit**. The **Opamp Wizard** dialog box closes and a “ghost” image of the circuit is placed on your cursor.
  9. Move the cursor to the desired location and click the mouse to place the circuit.

## 9.7 Simulation Error Log/Audit Trail

When you select **Simulate** to begin simulating the circuit using the chosen analysis or analyses, you may see one or both of the following views of the results:

- the error log/audit trail, which displays the results in text format (explained here)
- the **Grapher**, which displays the results in graphical format (explained in “11.2 Viewing the Analysis Results: Grapher” on page 11-4).

If you turn on the analysis option ACCT, the error log/audit trail also includes errors or warning messages generated during simulation, and a chart of simulation statistics. For more on analysis options, see “11.23 Analysis Options dialog box” on page 11-129.

- To display the error log/audit trail, from the **Simulate** menu choose **Simulation Error Log/Audit Trail**.

The error log/audit trail display is useful for diagnosing the analysis and its results. The following is a sample display:

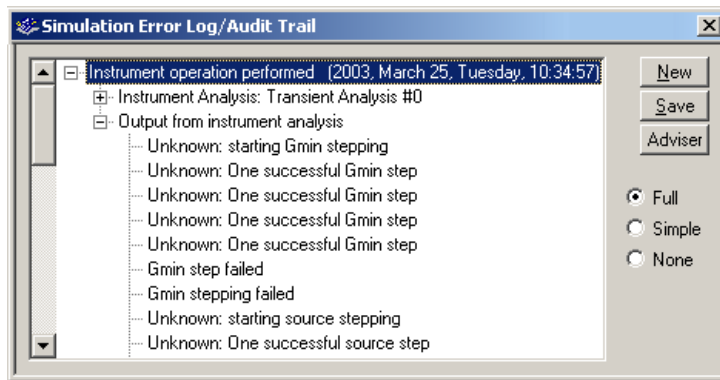

Each analysis you perform, either individually or in batch, during this Multisim session, is stored in the audit trail. The file is cleared when you exit Multisim.

You can expand or contract the contents of the display to show or hide details. You can also choose to display all the errors (**Full**), only the simple errors (**Simple**), or none of the errors (**None**) by choosing one of the options on the right of the dialog box. Regardless of the option you choose, the full set of errors is saved. You can also save the results of the audit trail in a separate file (click **Save** and choose a file name and location) or clear them (click **New**).

You can also display the **Simulation Adviser** by clicking **Adviser**. For details, see “Simulation Adviser” below.

## 9.8 Simulation Adviser

The **Simulation Adviser** provides trouble-shooting information for errors that you may encounter during simulation.

➤ To show the **Simulation Adviser**:

1. Highlight the desired error in the **Simulation Error Log/Audit Trail** dialog box as in the following example.

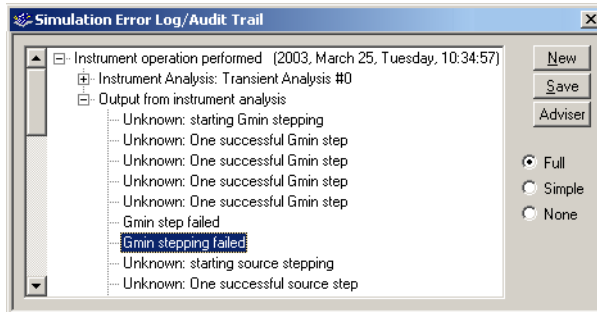

2. Click **Adviser**. The **Simulation Adviser** displays with information for the highlighted error.

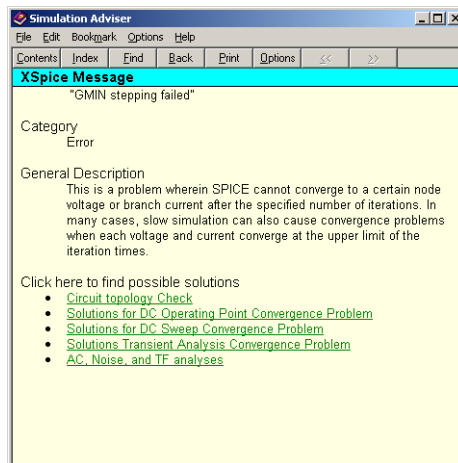

## 9.9 Saving/Loading Simulation Profiles

You can save simulation profiles that contain specific settings for the analyses you have used. These profiles can be used in other circuits instead of re-entering the settings for the various analyses.

**Note** For information on analyses, see “11.1 Introduction to Multisim Analyses” on page 11-4.

### 9.9.1 Saving a Simulation Profile

➤ To save the simulation settings from the current circuit:

1. Select **Simulate/Save Simulation Settings**.
2. Navigate to the desired location, enter the Filename for the profile, and click **Save**. The following dialog box displays.

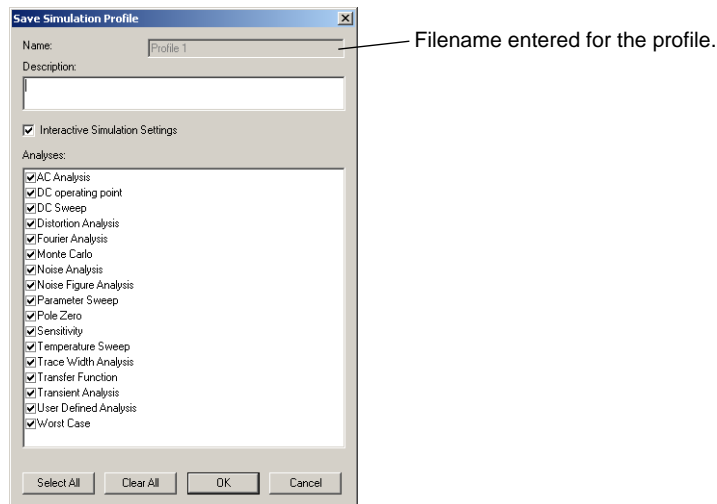

3. Optionally, enter a **Description** of the profile.
4. Enable **Interactive Simulation Settings** if you wish to save custom settings that you entered in the **Interactive Simulation Settings** dialog box. For details, see “10.3 Interactive Simulation Settings” on page 10-8.
5. In the **Analyses** area, select the analyses that you wish to include in this profile.
6. Click **OK** to finish.

## 9.9.2 Loading a Simulation Profile

- To load an existing simulation profile:
  1. Select **Simulate/Load Simulation Settings**, navigate to the desired profile and click **Open**. The following dialog displays.

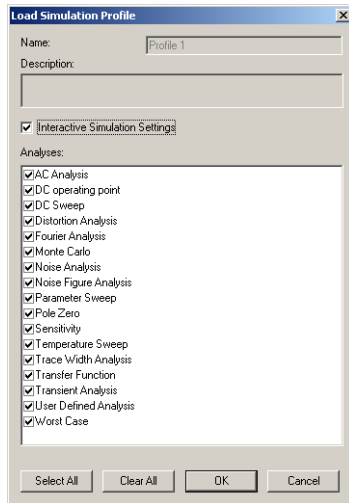

2. Enable **Interactive Simulation Settings** if you wish to load the custom interactive simulation settings that you saved with the profile.
3. Select the **Analyses** whose saved profiles you would like to load and click **OK**.

## 9.10 Using Simulation for Better Designs

Simulating a design can result in fewer iterations and less chance of errors in the prototype stage of product development. When a design is simulated at the front end of the design process, the number of design cycles can be significantly reduced.

The following tips will lead to successful simulation and more accurate board designs:

1. **Simulate using ideal models and add complexity incrementally** — Often, a design is based on standard configurations in which each part of a circuit is described and then refined over a number of iterative cycles. At this stage, it is best to begin simulation using ideal models, or at least simplified models of the components. The simulation will generally converge more quickly because the model does not have all the parametric data associated with its real-world component. (Convergence is the mathematical ability of the simulation engine to solve the equations it uses to represent the circuit). Early in the design cycle, ideal



models will offer faster simulation speeds and provide sufficient accuracy to determine if the design is headed in the right direction.

“Virtual” components let you select any theoretical value and replace it later with a part from a database of actual components. Interactive parts permit parameters of a component to be varied during simulation, and let you observe the effects on the circuit’s performance in real time. Initially, it is usually appropriate to ignore the parasitic side effects that add complexity to the models and lengthen the simulation time. Once the general desired circuit operation has been obtained, component models can be replaced with those that more precisely represent the actual component.

2. **Simulate critical areas of the design** — A structured modular approach permits isolation of each element in the design and ensures each circuit block is behaving as expected before being integrated into the whole. For all but the most straightforward designs, the best method for achieving this is a hierarchical approach. This leads to the creation of reusable modules that can be used in other designs at a later time.

Most of those who perform design entry with schematic capture software do so as part of their standard design flow. Employing this “block design” method simplifies the use of simulation software, since each sub-block can be simulated using the expected stimulus at the interface points.

The stimulus can be generated internally by the simulator using a wide variety of sources, including standard waveforms, various modulators, controlled sources and complex polynomial functions.

Examples of dividing a circuit into blocks for simulation include: an amplifier stage in which the signal-to-noise ratio must be thoroughly understood; the impedance matching of different stages in a network; a test bench that accurately represents real-world conditions.

3. **Analyze the results, starting with less complex methods first** — Simulation software is ultimately used to examine the signals at various points in a circuit. There are several methods of increasing sophistication that can be used to analyze these signals. Consider these three alternatives in ascending levels of complexity: virtual instrumentation; simulation analyses; post-processing.
4. **Consider HDL models for complex digital ICs** — Digital devices can be modeled in several ways. For smaller ICs, the best method for modeling is using SPICE and the digital extensions built into the simulator.

For example, think of the 7400 series TTL chips or 4000 series CMOS devices. Most of these devices typically use smaller-scale integration and fewer gates, and are adequately modeled using SPICE. However, larger ICs with many thousands of gates are best modeled with VHDL.

Writing a SPICE model for complex devices is not practical in most cases. Such complex digital chips can even include programmable devices. FPGAs and CPLDs can be

programmed in VHDL and then integrated into the overall design using their HDL code as the simulation modeling language.

Co-simulation, as this method is known, integrates the simulation results from the HDL simulators and the SPICE simulation engine and generates a combined set of results that can then be analyzed. With co-simulation, all devices on a board can be simulated as one complete circuit. The need to create elaborate test benches is reduced because the input stimuli to the device under test can be the result of the SPICE or HDL simulation.

5. **Models** — To enable easy simulation with your schematic software, remember the distinction between symbols and models. Models are to simulation as symbols are to schematics. Multisim includes extensive libraries of models for all of its parts. In addition, to accommodate new devices entering the market, you can add new models to existing libraries. This can be done using Multisim's **Model Makers** that permit databook parameters to be entered directly. The databook parameters are then converted into SPICE parameters for use by the simulator.

You can also obtain part models from the Internet. Most manufacturers that offer SPICE or HDL provide component models on their websites.

# Chapter 10

## Instruments

This chapter explains how to use the numerous virtual instruments provided as part of Multisim 9. It explains both the general procedures for attaching and configuring the instruments, and the specific steps for using each instrument. This chapter also explains how to create your own custom instruments using the National Instruments LabVIEW graphical development environment.



Some of the features described in this chapter may not be available in your edition of Multisim 9. Such features have an icon in the column next to their description. Refer to the release notes for a list of the features in your edition.

The following instruments are described in this chapter.

<b>Subject</b>	<b>Page No.</b>
<b>Introduction to the Multisim Instruments</b>	10-3
Saving Simulation Data with Instruments	10-4
Adding an Instrument to a Circuit	10-5
Using the Instrument	10-5
Working with Multiple Instruments	10-6
Saving Instrument Data	10-7
<b>Printing Instruments</b>	10-7
Print Instruments Dialog	10-7
<b>Interactive Simulation Settings</b>	10-8
Troubleshooting Simulation Errors	10-9
<b>Multimeter</b>	10-10
Using the Multimeter	10-11
<b>Function Generator</b>	10-14
Using the Function Generator	10-16
<b>Wattmeter</b>	10-17
Using the Wattmeter	10-18

<b>Subject</b>	<b>Page No.</b>
<b>Oscilloscope</b>	10-18
Using the Oscilloscope	10-20
<b>Bode Plotter</b>	10-23
Using the Bode Plotter	10-25
<b>Word Generator</b>	10-28
Using the Word Generator	10-29
<b>Logic Analyzer</b>	10-31
Using the Logic Analyzer	10-33
<b>Logic Converter</b>	10-35
Using the Logic Converter	10-36
<b>Distortion Analyzer</b>	10-38
Using the Distortion Analyzer	10-39
<b>Spectrum Analyzer</b>	10-40
<b>Network Analyzer</b>	10-40
<b>Measurement Probe</b>	10-40
Using the Measurement Probe	10-42
<b>Four-channel Oscilloscope</b>	10-47
Using the Four-channel Oscilloscope	10-48
<b>Frequency Counter</b>	10-57
Using the Frequency Counter	10-57
<b>IV Analyzer</b>	10-60
Using the IV Analyzer	10-61
Reviewing IV Analyzer Data	10-67
<b>Agilent Simulated Instruments</b>	10-70
Agilent Simulated Function Generator	10-71
Agilent Simulated Multimeter	10-74
Agilent Simulated Oscilloscope	10-77
<b>Tektronix Simulated Oscilloscope</b>	10-82
Supported Features	10-82
Features Not Supported	10-84
Using the Tektronix Oscilloscope	10-84
<b>Voltmeter</b>	10-85
Using the Voltmeter	10-85
<b>Ammeter</b>	10-86
Using the Ammeter	10-86

<b>Subject</b>	<b>Page No.</b>
<b>LabVIEW Instruments</b>	10-87
System Requirements	10-88
Sample LabVIEW Instruments	10-88
Creating a LabVIEW Instrument	10-90
Building a LabVIEW Instrument	10-92
Installing a LabVIEW Instrument	10-93
Guidelines for Successfully Creating a LabVIEW Instrument	10-93

## 10.1 Introduction to the Multisim Instruments

Multisim provides a number of virtual instruments. You use these instruments to measure the behavior of your circuits. These instruments are set, used and read just like their real-world equivalents. They look just like the instruments you've seen and used in a lab. Using virtual instruments is the easiest way to examine your circuit's behavior and show the results of a simulation. In addition to the standard instruments that come with Multisim, you can create your own custom instruments using LabVIEW, a graphical development environment for creating flexible and scalable test, measurement, and control applications.

Virtual instruments have two views: the instrument icon you attach to your circuit, and the instrument face, where you set the instrument's controls. You can show or hide the face by double-clicking on the instrument's icon. The instrument faces will always be drawn on top of the main workspace so that they will not be hidden. You may place the instrument faces wherever you wish on your desktop. The faces are automatically hidden when you activate a different view. Upon returning to a view, the instruments are restored to their original visibility and placement. When you save your circuit, the instrument face locations and hide/show status are stored with the circuit. As well, any data contained in the instruments is saved,

up to some maximum size (see “10.1.1 Saving Simulation Data with Instruments” on page 10-4).

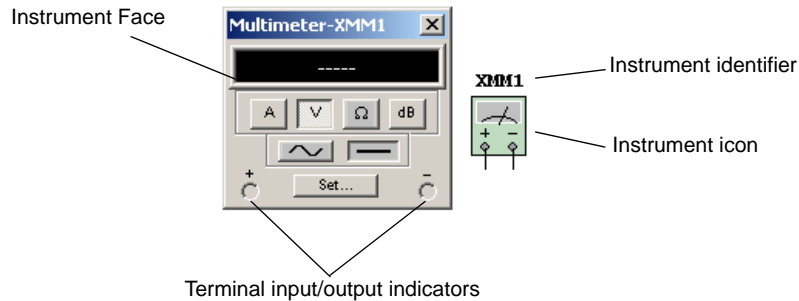

The instrument’s icon indicates how the instrument is connected into the circuit. Once the instrument is connected to the circuit, a black dot appears inside the terminal input/output indicators on the instrument face.

## 10.1.1 Saving Simulation Data with Instruments

If **Save simulation data with instruments** in the **Save** tab of the **Preferences** dialog box is checked, the data displayed on the instruments faces will be saved in the circuit file (in addition to instrument settings and visibility state that are always saved). Because instruments such as the oscilloscopes may contain a lot of data, file sizes may become very large (despite the compression algorithms that are used during save). For this reason, you may set a maximum size threshold. If upon saving the maximum threshold is exceeded you will be asked whether you wish to save the instrument data anyways, save a subset of the instrument data, or save no instrument data.

**Note** Whether Multisim saves the data for a LabVIEW instrument depends on the individual instrument.

## 10.1.2 Adding an Instrument to a Circuit

- To add an instrument to a circuit:
  1. By default the instruments toolbar is displayed on the workspace. If the instrument toolbar is not displayed, click **View/Toolbars/Instruments**. The **Instruments** toolbar appears, with one button for each instrument.

You may also right-click in any of the blank toolbar areas and select **Instruments** from the pop-up that appears.

(LabVIEW instruments appear in a sub-menu at the end of the **Instruments** toolbar).

2. From the **Instruments** toolbar, click the button of the instrument you want to use.

To add a LabVIEW instrument, click the **LabVIEW Instruments** button and select the instrument you want to place from the sub-menu that appears.

**Note** See also, “3.2.7 Instruments Toolbar” on page 3-11.

3. Move the cursor to the location on the circuit window where you want to place the instrument and click. The instrument is placed with the connections landing on the grid.

The instrument icon and the instrument identifier appear. The instrument identifier identifies the type of instrument and its instance. For example, the first multimeter you place on a circuit is called “XMM1”, the second is “XMM2”, and so on. This numbering is unique within each circuit. That is, if you create a second circuit, the first multimeter placed in it is “XMM1”, and so on.

**Note** Not all Multisim editions support all instruments or multiple instances of an instrument.

4. To wire the instrument into the circuit, click on a terminal on the instrument’s icon and drag a wire to the desired location in the circuit (a pin, wire, or junction). All the rules for component wiring, described in Chapter 4, “Schematic Capture - Basics”, apply to instruments as well.

**Note** The voltmeter and the ammeter are found in the **Indicators** component group. They are not accessed by the method described above. For details on these instruments, including connection, see “10.21 Voltmeter” on page 10-85 and “10.22 Ammeter” on page 10-86.

## 10.1.3 Using the Instrument

- To use the instrument:
  1. To view and modify an instrument’s controls, double-click its icon. The instrument face appears. Make any necessary changes to the control settings, just as you would on their

real-world equivalents. The control settings are different for each instrument, so if you are unfamiliar with them or need instruction, refer to the section on that particular instrument in this chapter.

It is *critical* that the control settings be appropriate for your circuit. If the settings are incorrect, this may cause the simulation results to appear incorrect or difficult to read.

**Note** Not all areas of the open instrument are modifiable. A hand appears when your cursor is on a control that can be modified.



2. To “activate” the circuit, click the **Run/stop simulation** button on the **Main** toolbar. Multisim begins to simulate the circuit’s behavior and the signals, as measured at the points to which you have connected the instrument, are displayed.

The simulation results depend on the circuit’s construction. During simulation, messages about the simulation results and any problems with the simulation are written to the simulation error log/audit trail. If you want to keep an eye on the progress of the simulation, you can display the error log/audit trail during simulation. To display it, from the **Simulate** menu choose **Simulation Error Log/Audit Trail**. For more detailed information about simulation, see Chapter 9, “Simulation”.

While the circuit is activated, you can adjust instrument settings. You cannot change the circuit by changing values (except for variable components), or perform any schematic capture functions such as rotate or component replacement as these would invalidate the netlist.

- To pause the simulation, select **Simulate/Pause**.  
You can also run, stop, pause, or resume using commands from the **Simulate** menu.
- To stop the simulation, click the **Run/stop simulation** button on the **Main** toolbar. The simulation ends, with the final results shown on the instrument face and in the audit trail.

## 10.1.4 Working with Multiple Instruments



A single circuit can have multiple instruments attached to it, including (for some editions) multiple instances of the same instrument. In addition, each circuit window can have its own set of instruments. Setting up many different instruments or multiple instances of one instrument is done in exactly the same way as setting up one instrument.

Instruments that sample for a period of time cause a transient analysis to be run. If you use multiples of such instruments, only one transient analysis is run. The settings of this analysis are derived from considering all the concurrent instruments and choosing settings that will satisfy each. For example, if you have two oscilloscopes with two different time-bases (resolutions), Multisim uses the time-base of the oscilloscope with the smallest time-base



(highest resolution). As a result, both instruments will sample at a higher resolution than they would individually.

The results from each instrument are recorded separately in the error log/audit trail.

## 10.1.5 Saving Instrument Data

You can set up your circuit so that data displayed on instruments are saved when the circuit is saved. For details, see “3.4.1.2 Preferences - Save Tab” on page 3-22.

**Note** Whether Multisim saves the data for a LabVIEW instrument depends on the individual instrument.

## 10.2 Printing Instruments

Multisim lets you print out the faces of selected instruments in your circuit. Any simulation data for the circuit appears on the printout.

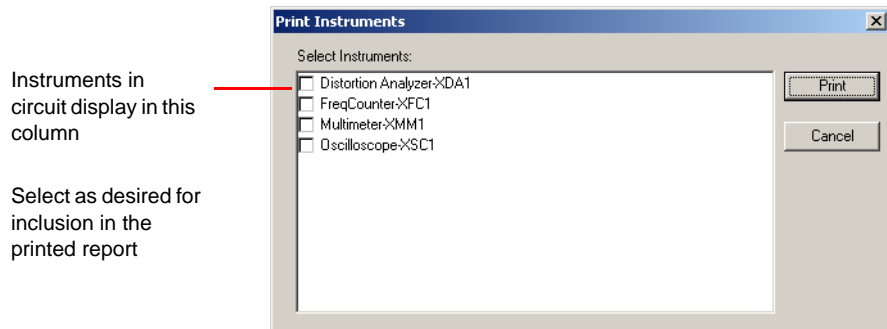

**Note** Multisim does not print the faces of LabVIEW instruments.

### 10.2.1 Print Instruments Dialog

- To produce a print-out of the instrument faces:
  1. Have the desired circuit open in your workspace.
  2. Select **File/PrintOptions/Print Instruments**. The **Print Instruments** dialog box appears.
  3. Click on the checkbox beside any instrument to select/deselect it, then click **Print** to print the selected instruments.
  4. A standard print dialog appears. Choose the desired print options and click **OK**.

## 10.3 Interactive Simulation Settings

Multisim lets you set default settings for instruments that are based on a transient analysis (such as the oscilloscope, spectrum analyzer and logic analyzer).

- To set the default instrument settings:
  1. Choose **Simulate/Interactive Simulation Settings**. A streamlined **Interactive Simulation Settings** dialog box appears displaying the most commonly used functions.
  2. Click **More**. The full dialog box appears:

Set initial conditions: Zero, User-Defined, Calculate DC Operating Point, or Automatically Determine Initial Conditions.

Start time of transient analysis must be greater than or equal to 0 and less than End time.

End time of transient analysis must be greater than Start time.

Enable to enter the maximum time step the simulation can handle.

Enable to manually set time steps.

Enable to generate time steps automatically.

Enable to set a time interval for simulation output and graphing.

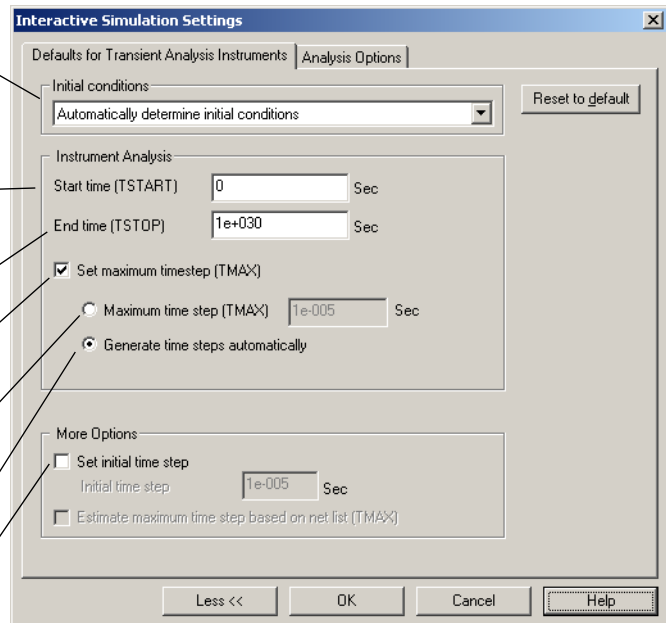

3. Enter settings as desired and click **OK**. These settings will be in effect the next time you run a simulation.

You can control many aspects of the simulation, such as resetting error tolerances, selecting simulation techniques, and viewing the results. The options you choose will determine the efficiency of the simulation. See “11.23 Analysis Options dialog box” on page 11-129 for details on the analysis options and their default values. You set these options through the **Analysis Options** tab.

## 10.3.1 Troubleshooting Simulation Errors

The default values in the **Default Instrument Settings** dialog box are set so the majority of circuits will simulate correctly. However in some cases, it will be necessary to adjust these values.

When running simulation, Multisim may encounter time-step difficulties depending on the circuit configuration. This may cause inaccurate simulation or simulation errors.

- To adjust the **Default Instrument Settings** values follow the steps below:
  1. Start Multisim and load the circuit file exhibiting the problem.
  2. Select **Simulate/Interactive Simulation Settings**.
  3. Select the **Defaults for Transient Analysis Instruments** tab, and set the following:
    - Select **Set to zero** from the **Initial conditions** pull-down menu.
    - Select **Maximum time step (TMAX)** and change the value to 1e-3 sec.
  4. Click **Accept** and run simulation.
- If the problem persists, follow the additional steps below:
  1. Select **Simulate/Interactive Simulation Settings**.
  2. Select the **Analysis Options** tab, enable **Use Custom Settings** and click **Customize** to display the **Analysis Options** dialog box.
  3. In the **Global** tab, set the following:
    - Enable the **reltol** parameter and set the value to 0.01 (or for better accuracy try 0.0001).
    - Enable the **rshunt** parameter and set the value to 1e+8 (do this only if you are experiencing simulation error messages).
  4. Click **OK** twice and run simulation.
- If the problem continues to persists, follow the additional steps below:
  1. Select **Simulate/Interactive Simulation Settings**.
  2. Select the **Analysis Options** tab, enable **Use Custom Settings** and click **Customize** to display the **Analysis Options** dialog box.
  3. In the **Transient** tab, set the following:
    - Enable the **METHOD** parameter and set it to **gear** from the pull-down menu.
  4. Click **OK** twice and run simulation.

## 10.4 Multimeter

Use the multimeter to measure AC or DC voltage or current, and resistance or decibel loss between two nodes in a circuit. The multimeter is auto-ranging, so a measurement range does not need to be specified. Its internal resistance and current are preset to near-ideal values, which can be changed (see “Internal Settings - Multimeter Settings Dialog Box” on page 10-13).

To use the instrument, click on the **Multimeter** button in the **Instruments** toolbar and click to place its icon on the workspace. The icon is used to wire the Multimeter to the circuit. Double-click on the icon to open the instrument face, which is used to enter settings and view measurements.

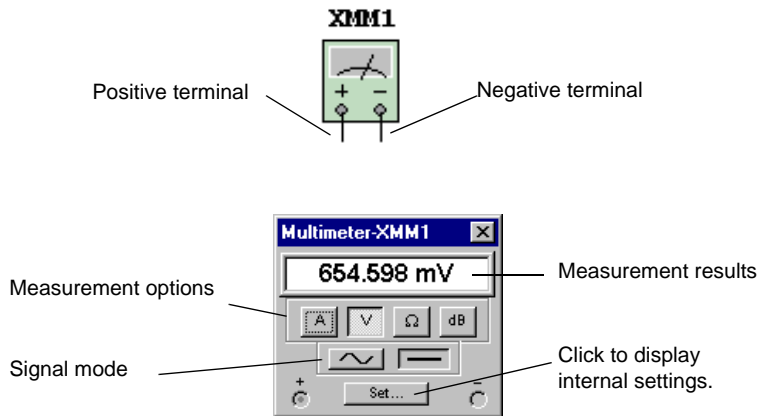

**Note** You should read “10.1.2 Adding an Instrument to a Circuit” on page 10-5 and “10.1.3 Using the Instrument” on page 10-5 before using this instrument.

## 10.4.1 Using the Multimeter

### 10.4.1.1 Multimeter Settings

This section provides details on how to set up your multimeter.

#### Measurement Options

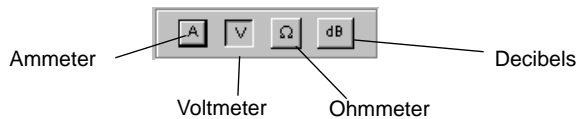

➤ To select the type of measurement to be taken:

1. Click on one of the following buttons:



- **Ammeter**—measures current flowing through the circuit in a branch between two nodes. Insert the multimeter in series with the load to measure current flow, just like a real ammeter (as shown in diagram below).

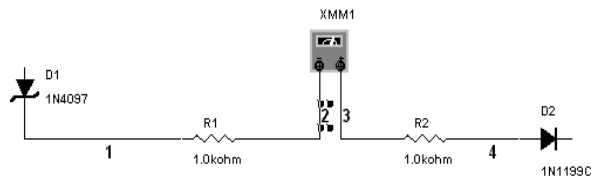

To measure current at another node in the circuit, connect another multimeter in series at that load and activate the circuit again. When used as an ammeter, the multimeter's internal resistance is very low (1 nOhm). To change the resistance, click **Set**.

See “Internal Settings - Multimeter Settings Dialog Box” on page 10-13 for details.



- **Voltmeter**—measures voltage between two nodes. Select **V** and attach the voltmeter's probes in parallel with the load (as shown in diagram below).

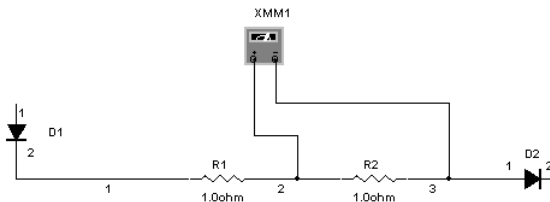

When used as a voltmeter, the multimeter has a high internal resistance of 1 Gohm,

which can be changed by clicking **Set**. See “ Internal Settings - Multimeter Settings Dialog Box” on page 10-13 for details.



- **Ohmmeter**—This option measures resistance between two nodes. The nodes and everything that lies between them are referred to as the “component network”. To measure the resistance, select this option and attach the multimeter’s probes in parallel with the component network (as shown in the diagram below).

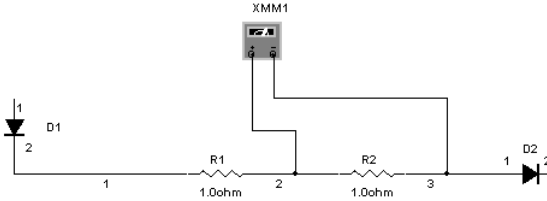

To get an accurate measurement, make sure that:

- there is no source in the component network
- the component or component network is grounded
- there is nothing else in parallel with the component or component network.

The ohmmeter generates a 10 nA current, which can be changed by clicking **Set**. See “ Internal Settings - Multimeter Settings Dialog Box” on page 10-13 for details. If you change the ohmmeter connections, re-activate the circuit to get a reading.



- **Decibels**—measures decibel voltage loss between two nodes in a circuit. To measure the decibels, select this option and attach the multimeter’s probes in parallel with the load (as shown in diagram below).

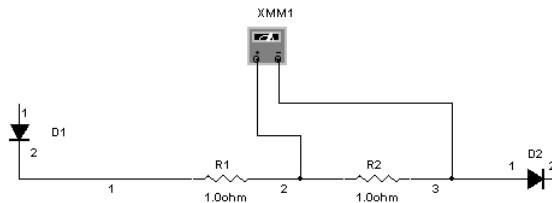

The Decibel standard for calculating dB is preset to 774.69 mV, but can be changed by clicking **Set**. See “ Internal Settings - Multimeter Settings Dialog Box” on page 10-13 for details. Decibel loss is calculated as follows:

$$dB = 20 * \log_{10} \left( \frac{V_{out}}{V_{in}} \right)$$

## Signal Mode (AC or DC)



The **Sine-wave** button measures the root-mean-square (RMS) voltage or current of an AC signal. Any DC component of the signal will be eliminated, so only the AC component of the signal is measured.



The **DC** button measures the current or voltage value of a DC signal.

**Note** To measure the RMS voltage of a circuit with both AC and DC components, connect an AC voltmeter as well as a “DC” voltmeter across the appropriate nodes and measure the AC and DC voltage.

The following formula can be used to calculate RMS voltage when both AC and DC components are in the circuit. Be advised that this is not a universal formula and should be used in conjunction with Multisim only.

$$\text{RMS voltage} = \sqrt{(V_{dc}^2 + V_{ac}^2)}$$

## Internal Settings - Multimeter Settings Dialog Box

Ideal meters have no effect on the circuit being measured. An ideal voltmeter would have infinite resistance, so no current could flow through it while it is attached to a circuit. An ideal ammeter would present no resistance to a circuit. Real meters do not achieve this ideal, so their readings will very closely match theoretical, calculated values for a circuit, but never with absolute precision.

The multimeter in Multisim uses very small and very large numbers that approximate zero and infinity to calculate near-ideal values for the circuit. For special cases, however, the meter’s behavior can be changed by changing these values used to model its effect on the circuit. (The values must be higher than 0.)

For example, if testing the voltage of a circuit with very high resistance, increase the voltmeter’s resistance. If measuring the current of a circuit with very low resistance, decrease the ammeter’s resistance even further.

**Note** Very low ammeter resistance in a high-resistance circuit may result in a mathematical roundoff error.

- To display the default internal settings:
1. Click **Set**. The **Multimeter Settings** dialog box appears.

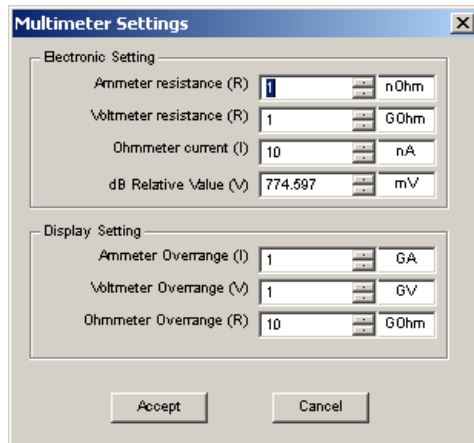

2. Change the desired options.
3. To save your changes, click **OK**. To cancel them, click **Cancel**.

## 10.5 Function Generator

The function generator is a voltage source that supplies sine, triangular or square waves. It provides a convenient and realistic way to supply stimulus signals to a circuit. The waveform can be changed and its frequency, amplitude, duty cycle and DC offset can be controlled. The function generator's frequency range is great enough to produce conventional AC as well as audio- and radio-frequency signals.

The function generator has three terminals through which waveforms can be applied to a circuit. The common terminal provides a reference level for the signal.

To use the instrument, simply click on the **Function Generator** button in the **Instruments** toolbar and click to place its icon on the workspace. The icon is used to wire the Function Generator to the circuit. Double-click on the icon to open the instrument face, which is used to



enter settings and view measurements. For details see “10.5.1 Using the Function Generator” on page 10-16.

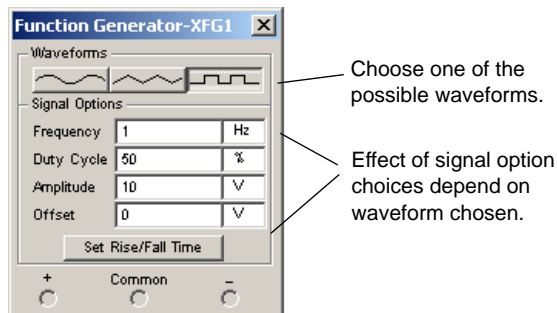
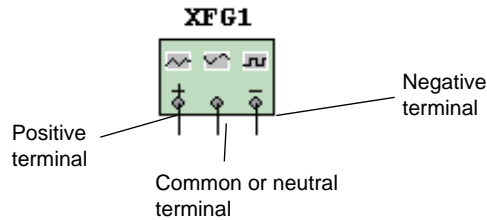

- To reference a signal from ground, connect the common terminal to the ground component.

The positive terminal (+) provides a waveform in the positive direction from the neutral common terminal. The negative terminal (-) provides a waveform in the negative direction.

**Note** If you are not familiar with connecting and adjusting the settings of the instruments, see “10.1.2 Adding an Instrument to a Circuit” on page 10-5 and “10.1.3 Using the Instrument” on page 10-5 before using this instrument.

## 10.5.1 Using the Function Generator

### 10.5.1.1 Function Generator Settings

#### Waveform Selection

You can select three different types of waveforms as the output.

- To select the waveform, click the Sine-, Triangular- or Square-wave button.
- To set the rise/fall time parameters for square waves:
  1. Click the Square-wave button. The **Set Rise/Fall Time** button becomes active.
  2. Click the **Set Rise/Fall Time** button to display the **Set Rise/Fall Time** dialog box.

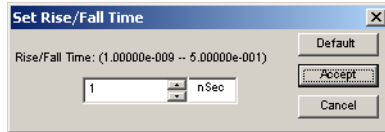

3. Enter the desired rise/fall time and click **Accept**.

#### Signal Options

**Frequency** (1Hz — 999 MHz) — This setting determines the number of cycles per second the function generator generates.

**Duty Cycle** (1% — 99%) — This setting determines the ratio of on-period to off-period. It affects the shape of triangular and square waves as shown below. A sine wave is not affected by the duty cycle setting.

**Amplitude** (1mV — 999 kV) — This setting controls the signal's voltage, measured from its DC level to its peak. If the leads are connected to the common and either the positive or the negative terminal, the wave's peak-to-peak measurement is twice its amplitude. If the output comes from the positive and negative terminals, the wave's peak-to-peak measurement is four times its amplitude.

**Offset** (-999 kV and 999 kV) — This option controls the DC level about which the alternating signal varies. An offset of 0 positions the waveform along the oscilloscope's x-axis (provided its Y POS setting is 0). A positive value shifts the DC level upward, while a negative value shifts it downward. Offset uses the units set for Amplitude.

## 10.6 Wattmeter

The wattmeter measures power. It is used to measure the magnitude of the active power, that is, the product of the voltage difference and the current flowing through the current terminals in a circuit. The results are shown in Watts. The wattmeter also displays the power factor, calculated by measuring the difference between the voltages and the current, and multiplying them together. The power factor is the cosine of the phase angle before the voltage and current.

To use the instrument, click on the **Wattmeter** button in the **Instruments** toolbar and click to place its icon on the workspace. The icon is used to wire the Wattmeter to the circuit. Double-click on the icon to open the instrument face, which is used to enter settings and view measurements.

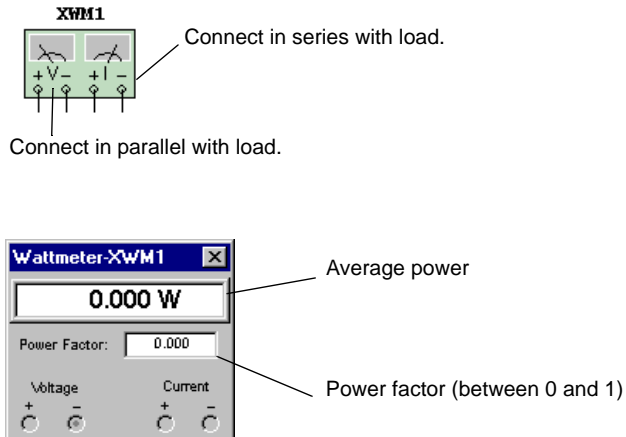

## 10.6.1 Using the Wattmeter

### 10.6.1.1 Connecting the Wattmeter

An example of a connected wattmeter is shown below. For details on connecting instruments, including the Wattmeter, see “10.1.2 Adding an Instrument to a Circuit” on page 10-5.

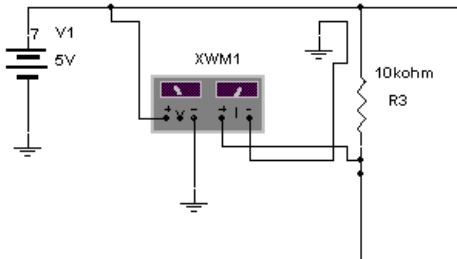

**Note** If you are not familiar with connecting and adjusting the settings of the instruments, see “10.1.2 Adding an Instrument to a Circuit” on page 10-5 and “10.1.3 Using the Instrument” on page 10-5 before using this instrument.

## 10.7 Oscilloscope

To use the instrument, click on the **Oscilloscope** button in the **Instrument** toolbar and click to place its icon on the workspace. The icon is used to wire the Oscilloscope to the circuit. Double-click on the icon to open the instrument face, which is used to enter settings and view measurements. For details see “10.7.1 Using the Oscilloscope” on page 10-20.

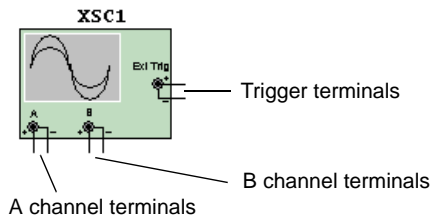

The dual-channel oscilloscope displays the magnitude and frequency variations of electronic signals. It can provide a graph of the strength of one or two signals over time, or allow comparison of one waveform to another.

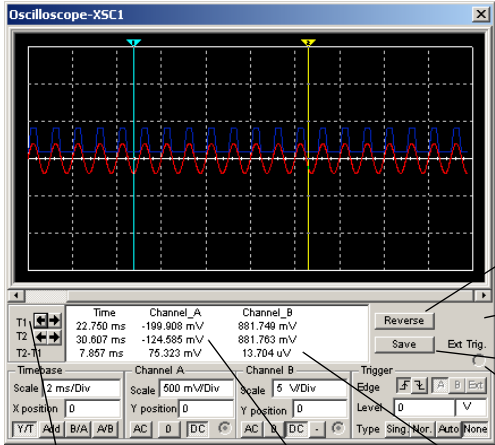

- Graphical display
- Reverses background color (toggles between white and black).
- Grounds the oscilloscope.
- Save results as a scope (.scp), text-based measurement(.lvm) or binary (.tdm) file.
- External Trigger

- Readouts at vertical cursor 1.
- Readouts at vertical cursor 2.
- Difference between readouts at vertical cursors.

**Note** Along with the oscilloscope’s **Save** button, you can also save simulation results in the **Grapher** window. For details, see “11.2.5 Opening and Saving Files” on page 11-21.

**Note** If you are not familiar with connecting and adjusting the settings of the instruments, see “10.1.2 Adding an Instrument to a Circuit” on page 10-5 and “10.1.3 Using the Instrument” on page 10-5 before using this instrument.

## 10.7.1 Using the Oscilloscope

### 10.7.1.1 Oscilloscope Settings

#### Time Base

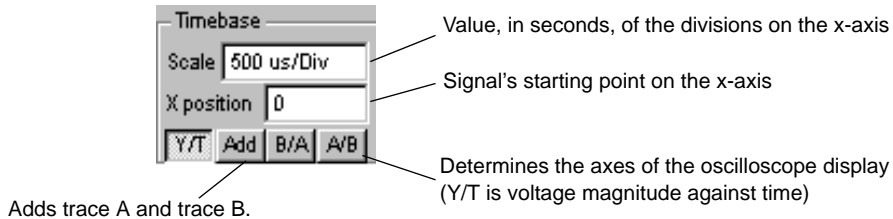

The time base setting controls the scale of the oscilloscope's horizontal or x-axis when comparing magnitude against time (Y/T).

- To get a readable display, adjust the time base in inverse proportion to the frequency setting on the function generator or AC source—the higher the frequency, the lower (or more magnified) the time base.

For example, if you want to see one cycle of a 1 kHz signal, the time base should be around 1 millisecond.

#### X Position

This setting controls the signal's starting point on the x-axis. When **X Position** is 0, the signal starts at the left edge of the display. A positive value (for example, 2.00) shifts the starting point to the right. A negative value (for example, -3.00) shifts the starting point to the left.

#### Axes (Y/T, A/B, and B/A)

The axes of the oscilloscope display can be switched from showing waveform magnitude against time (Y/T) to showing one input channel against the other (A/B or B/A). The latter settings display frequency and phase shifts, known as Lissajous patterns, or they can display a hysteresis loop. When comparing channel A's input against channel B's (A/B), the scale of the x-axis is determined by the volts-per-division setting for channel B (and vice versa).

#### Grounding

It is not necessary to ground the oscilloscope, as long as the circuit to which it is attached is grounded.

## Channel A and Channel B Settings

### Scale

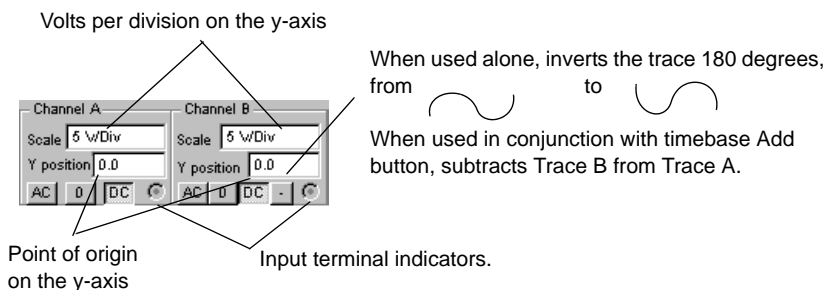

This setting determines the scale of the y-axis. It also controls the x-axis scale when A/B or B/A is selected.

To get a readable display, adjust the scale in relation to the channel's expected voltage. For example, an input AC signal of 3 volts fills the oscilloscope's display vertically when the y-axis is set to 1 V/Div. If the **Scale** setting is increased, the waveform will become smaller. If the **Scale** setting is decreased, the waveform's top will be cut off.

### Y Position

This setting controls the point of origin for the y-axis. When **Y position** is set to 0.00, the point of origin is the intersection with the x-axis. Increasing **Y position** to 1.00, for example, moves 0 (the point of origin) up to the first division above the x-axis. Decreasing **Y position** to -1.00 moves 0 down to the first division below the x-axis.

Changing the **Y position** setting for channels A and B may help distinguish their waveforms for comparison.

### Input Coupling (AC, 0, and DC)

With AC coupling, only the AC component of a signal is displayed. AC coupling has the effect of placing a capacitor in series with the oscilloscope's probe. As on a real oscilloscope using AC coupling, the first cycle displayed is inaccurate. Once the signal's DC component has been calculated and eliminated during the first cycle, the waveforms will be accurate.

With DC coupling, the sum of the AC and DC components of the signal is displayed. Selecting 0 displays a reference flat line at the point of origin set by **Y position**.

**Note** Do not place a coupling capacitor in series with an oscilloscope probe. The oscilloscope will not provide a path for current, and the analysis will consider the capacitor improperly connected. Instead, choose AC coupling.

## Trigger

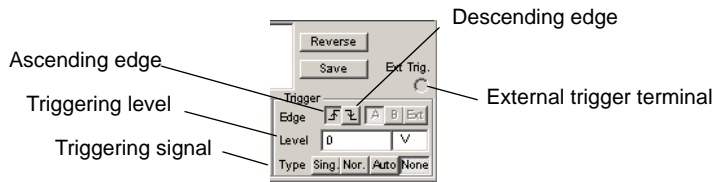

These settings determine the conditions under which a waveform is first displayed on the oscilloscope.

### Trigger Edge

- To start displaying the waveform on its positive slope or rising signal, click the “ascending edge” button.
- To start with the negative slope or falling signal, select the “descending edge” button.

### Trigger Level

The trigger level is the point on the oscilloscope’s y-axis that must be crossed by the waveform before it is displayed.

**Tip** A flat waveform will not cross the trigger level. To see a flat signal, make sure the triggering signal is set to **Auto**.

### Trigger Signal

Triggering can be internal, with reference to the input signal for channel A or B, or external, with reference to a signal through the external trigger terminal. If a flat signal is expected, or if signals are to be displayed as soon as possible, select **Auto**.

The **Sing** button is used to make the oscilloscope trigger a single pass when the trigger level is met. Once the trace gets to the end of the scope face, the trace will not change until you click **Sing** again.

The **Nor** button is used to make the oscilloscope refresh every time the trigger level is met.

The **None** button is used if you do not wish to set triggering.



## 10.7.1.2 Viewing Oscilloscope Results

### Using Cursors and Readouts

- To display the exact values of the wave, drag the vertical cursor until the desired value appears. You can also move a cursor to a precise location by right-clicking on it and using the pop-up menu that appears. For details, see “11.2.2.3 Cursor Pop-up Menu” on page 11-11.

The boxes below the display show the time and the voltage at the probe connections, where the vertical cursor intersects the sine wave, and the difference between the two positions.

Once a circuit has been activated and its behavior simulated, you may move the oscilloscope’s probes to other nodes without re-activating the circuit. Moving the probes automatically redraws the waveforms for the new nodes. If you fine-tune the oscilloscope’s settings either during or after simulation, the display redraws automatically.

**Note** If the oscilloscope settings or analysis options are changed to provide more detail, the waveforms may appear choppy or uneven. If so, activate the circuit again to get more detail. You can also increase the precision of a waveform by increasing the simulation time step using the default instrument settings, as explained in “10.3 Interactive Simulation Settings” on page 10-8.

## 10.8 Bode Plotter

To use the instrument, click on the **Bode Plotter** button in the **Instruments** toolbar and click to place its icon on the workspace. The icon is used to wire the Bode Plotter to the circuit. Double-click on the icon to open the instrument face, which is used to enter settings and view measurements. For details see “10.8.1 Using the Bode Plotter” on page 10-25.

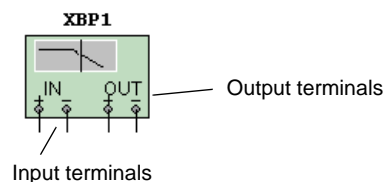

The Bode Plotter produces a graph of a circuit's frequency response and is most useful for analyzing filter circuits. The Bode Plotter is used to measure a signal's voltage gain or phase shift. When the Bode Plotter is attached to a circuit, a spectrum analysis is performed.

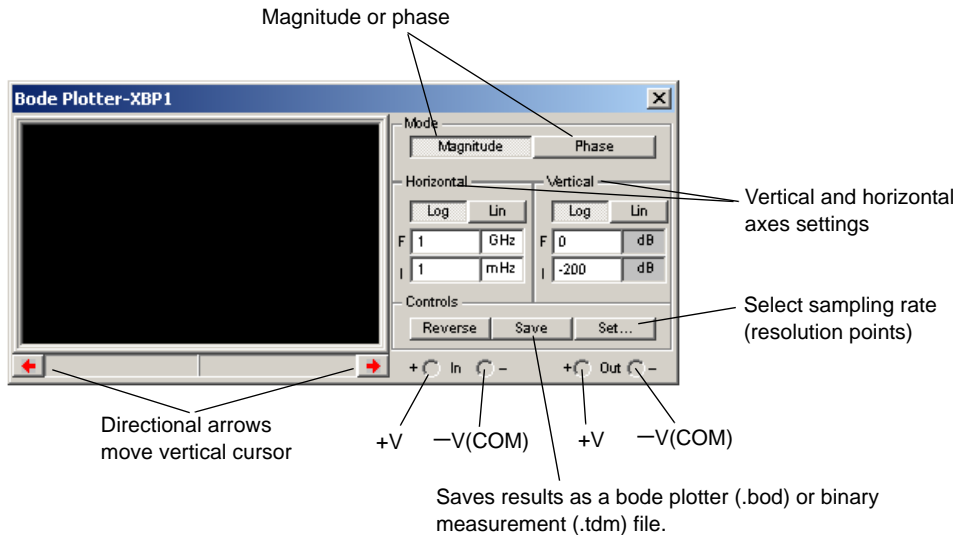

**Note** Along with the Bode Plotter's **Save** button, you can also save simulation results in the **Grapher** window. For details, see "11.2.5 Opening and Saving Files" on page 11-21.

The Bode Plotter generates a range of frequencies over a specified spectrum. The frequency of any AC source in the circuit does not affect the Bode Plotter. However, an AC source must be included somewhere in the circuit.

The initial and final values of the vertical and horizontal scales are preset to their maximum value. These values can be changed to see the plot on a different scale. If the scale is expanded or the base changed after simulation is complete, you may need to activate the circuit again to get more detail in the plot. Unlike most test instruments, if the Bode Plotter's probes are moved to different nodes, it is necessary to re-activate the circuit to ensure accurate results.

**Note** If you are not familiar with connecting and adjusting the settings of the instruments, see "10.1.2 Adding an Instrument to a Circuit" on page 10-5 and "10.1.3 Using the Instrument" on page 10-5 before using this instrument.

## 10.8.1 Using the Bode Plotter

### 10.8.1.1 Bode Plotter Settings

#### Resolution Points - Settings Dialog dialog box

- To set the resolution of your bode plot:
  1. Click on **Set** to display the **Settings Dialog**.
  2. Enter the desired number of **Resolution Points** and click **Accept**.

#### Magnitude or Phase

Magnitude measures the ratio of magnitudes (voltage gain, in decibels) between two nodes, V+ and V-. Phase measures the phase shift (in degrees) between two nodes. Both are plotted against frequency (in hertz).

- If V+ and V- are single points in a circuit:
  1. Attach the positive IN terminal and the positive OUT terminal to connectors at V+ and V-.
  2. Attach the negative IN and OUT terminals to a ground component.
- If V+ (or V-) is the magnitude or phase across a component, attach both IN terminals (or both OUT terminals) on either side of the component.

#### Vertical and Horizontal Axes Settings

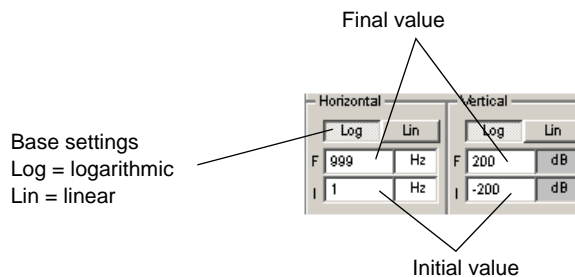

## Base Settings

A logarithmic base is used when the values being compared have a large range, as is generally the case when analyzing frequency response. For example, if measuring a signal's voltage gain, the decibel value is calculated as follows:

$$dB = 20 * \log_{10} \left( \frac{V_{out}}{V_{in}} \right)$$

The base scale can be changed from logarithmic (Log) to linear (Lin) without the circuit being activated again. (Only when using a logarithmic scale is the resulting graph referred to as a Bode plot.)

## Horizontal Axis Scale

The horizontal or x-axis always shows frequency. Its scale is determined by the initial (I) and final (F) settings for the horizontal axis. Since a frequency response analysis requires a large frequency range, a logarithmic scale is often used.

**Note** When setting the horizontal axis scale, the initial (I) frequency must be less than the final (F) frequency.

## Vertical Axis Scale

The units and scale for the vertical axis depend on what is being measured and the base being used, as shown in the table below.

When Measuring...	Using the Base...	Minimum Initial Value is...	Maximum Final Value is...
Magnitude (gain)	Logarithmic	-200 dB	200 dB
Magnitude (gain)	Linear	0	10e+09
Phase	Linear	-720°	720°

When measuring voltage gain, the vertical axis shows the ratio of the circuit's output voltage to its input voltage. For a logarithmic base, the units are decibels. When measuring phase, the vertical axis always shows the phase angle in degrees. Regardless of the units, you can set initial (I) and final (F) values for the axis using the Bode plotter's controls.

**Note** When setting the vertical axis scale, the initial (I) frequency must be less than the final (F) frequency.

## 10.8.1.2 Viewing Bode Plotter Results

### Readouts

Move the Bode Plotter's vertical cursor to get a readout of the frequency and magnitude or phase at any point on the plot. The vertical cursor is stored at the left edge of the Bode Plotter display.

➤ To move the vertical cursor:

- click the arrows near the bottom of the Bode Plotter

*Or*

- drag the vertical cursor from the left edge of the Bode Plotter display to the point on the plot you want to measure.

**Note** You can also move the cursor by right-clicking on the cursor and using the pop-up menu that appears. For details, see “11.2.2.3 Cursor Pop-up Menu” on page 11-11. This feature is useful when locating the -3 dB point on a bode plot.

The magnitude (or phase) and frequency at the intersection of the vertical cursor and the trace are shown in the boxes beside the arrows.

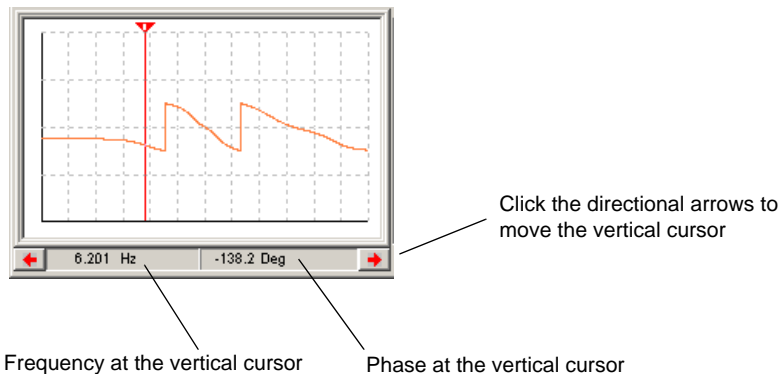

## 10.9 Word Generator

To use the instrument, click on the **Word Generator** button in the **Instrument** toolbar and click to place its icon on the workspace. The icon is used to wire the Word Generator to the circuit. Double-click on the icon to open the instrument face, which is used to enter settings and view measurements.

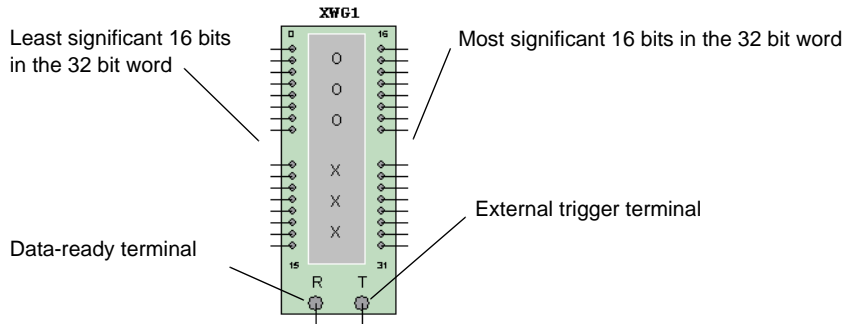

Use the word generator to send digital words or patterns of bits into circuits to provide stimulus to digital circuits:

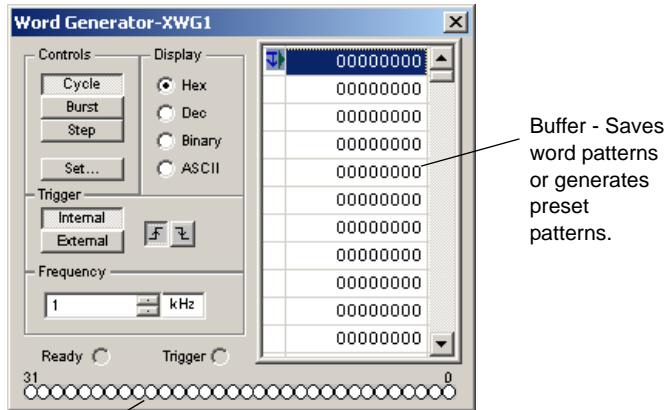

Output terminals, correspond to those on the word generator icon

**Note** If you are not familiar with connecting and adjusting the settings of the instruments, see “10.1.2 Adding an Instrument to a Circuit” on page 10-5 and “10.1.3 Using the Instrument” on page 10-5 before using this instrument.

## 10.9.1 Using the Word Generator

### 10.9.1.1 Word Generator Settings

#### Entering Words

The right side of the word generator instrument face displays rows of numbers, ranging from 00000000 to FFFFFFFF in hexadecimal (0 to 4,294,967,295 in decimal). The type of number that displays can be **Hex**, **Dec**, **Binary** or **ASCII**, depending on the button selected in the **Display** box. Each horizontal row represents one word. When the word generator is activated, a row of bits is sent in parallel to the corresponding terminals at the bottom of the instrument.

- To change a bit value in the word generator, select the number you want to modify and type the new value in its field using the appropriate number format.

As the words are transmitted by the word generator, the value of each bit appears in the circles representing the output terminals at the bottom of the instrument.

#### Controls

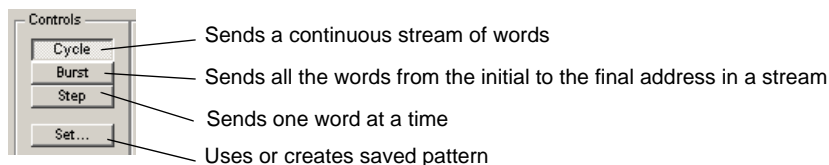

- To inject the 32-bit words into a circuit, click **Step**, **Burst** or **Cycle**.
- To transmit one word at a time into the circuit, click **Step**.
- To send all words in sequence, click **Burst**. Clicking **Cycle** sends a continuous stream of words that can be stopped by clicking the **Run/stop simulation** button on the **Main** toolbar.  
Use a breakpoint when you want to pause the stream of words at a specified word.
- To insert a breakpoint, select the word in the buffer scroll list where you want the input to stop, right-click and select **Set Breakpoint** from the pop-up that appears. A “stop sign” marks a breakpoint in the scroll list.
- To remove a breakpoint, right-click on an existing breakpoint in the buffer scroll list and select **Delete Breakpoint** from the pop-up that appears.  
More than one breakpoint can be used. Breakpoints affect both **Cycle** and **Burst**.

## Settings Dialog Box

Click **Set** to display a set of options that allow you to save word patterns entered in the word generator to a file and load previously saved word patterns. This function can also be used to generate useful patterns or to clear the display.

The Settings dialog box contains the following elements and callouts:

- Pre-Setting Patterns:**
  - No Change: Opens previously saved pattern
  - Load: Saves current pattern as a file
  - Save: Changes all words to hex 0000
  - Clear buffer: Creates pattern of subsequent words increasing or decreasing by 1
  - Up Counter
  - Down Count
  - Shift Right
  - Shift Left: Creates pattern such that the resulting binary words have a single 1 shifted to the left or right
- Display Type:**
  - Hex
  - Dec
- Buffer Size:** [(<= 0x2000)] with a text field containing 0400. Callout: Number of lines (words) in the buffer.
- Initial Pattern:** Text field containing 00000000. Callout: Enter the initial value for up or down counter or right or left shift.
- Buttons: Accept and Cancel.

## Triggering

The Trigger control panel includes the following elements and callouts:

- Internal/External:** Two buttons. Callouts:
  - Use internal triggering (points to Internal)
  - Use external trigger terminal (points to External)
- Edge Selection:** Two buttons with waveforms. Callouts:
  - Trigger on ascending edge of signal (points to the first button)
  - Trigger on descending edge of signal (points to the second button)

- To use the word generator clock to trigger input from the word generator’s input field to the circuit, click **Internal**. To use input through the external terminal instead, with each input cycle causing one word to be transmitted, click **External**.

Use the “ascending/descending edge” buttons to control whether the input signal triggers the word generator on its ascending or descending edge.

## Frequency and Data Ready





Set the clock frequency of the word generator in Hz, kHz or MHz. Each word is placed on the output terminals for the duration of one clock cycle.

Ready 

Lets the circuit know that data from the word generator is ready.

## 10.10 Logic Analyzer

To use the instrument, simply click on the **Logic Analyzer** button in the **Instrument** toolbar and click to place its icon on the workspace. The icon is used to wire the Logic Analyzer to the circuit. Double-click on the icon to open the instrument face, which is used to enter settings and view measurements.

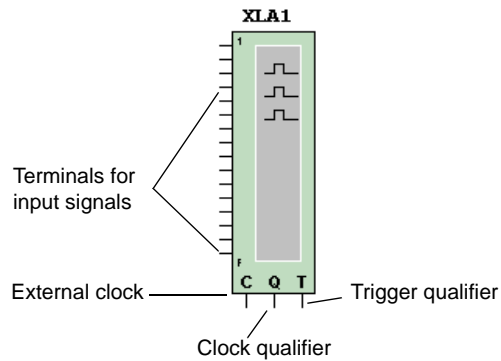

The logic analyzer displays the levels of up to 16 digital signals in a circuit. It is used for fast data acquisition of logic states and advanced timing analysis to help design large systems and carry out troubleshooting.

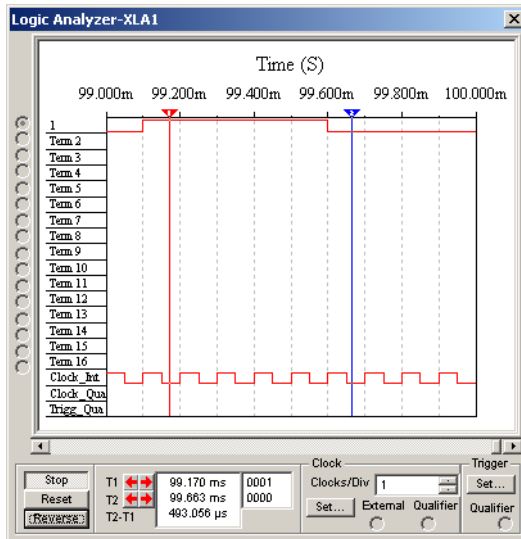

The 16 circles on the left side of the icon correspond to the terminals and horizontal rows across the instrument face. When the terminal is connected with a node, its circle is displayed with a black dot and the node's name and color are displayed. Otherwise the terminal circle is displayed without a black dot.

When a circuit is activated, the logic analyzer records the input values on its terminals. When the triggering signal is seen, the logic analyzer displays the pre- and post-trigger data. Data is displayed as square waves over time. The top row displays values for channel 0 (generally the first bit in a digital word), the next row displays values for channel 1, and so on. The binary value of each bit in the current word is displayed in the terminals on the left side of the instrument face. The time axis is displayed as the top axis of the signal display dialog box. The dialog box also displays the internal clock signal, external clock signal, external clock qualify signal and trigger qualify signal.

- To specify the number of samples stored before and after triggering, click **Set** in the **Clock** box or use the default instrument settings, as explained in “10.3 Interactive Simulation Settings” on page 10-8.

The logic analyzer stores data until it reaches the pre-trigger number of samples. Then, it begins discarding samples as new samples appear until it sees the trigger signal. After the trigger signal, samples are stored up to the value of the post-trigger samples.

The time position automatically displays the time position values of the two crosshair cursors, T1 and T2, when sampling stopped. It also automatically moves the first crosshair cursor T1 to the position of time zero, when sampling is stopped.

- To change the threshold voltage, use the default instrument settings, as explained in “10.3 Interactive Simulation Settings” on page 10-8.

**Note** If you are not familiar with connecting and adjusting the settings of the instruments, see “10.1.2 Adding an Instrument to a Circuit” on page 10-5 and “10.1.3 Using the Instrument” on page 10-5 before using this instrument.

## 10.10.1 Using the Logic Analyzer

### 10.10.1.1 Logic Analyzer Settings

#### Stop & Reset

Selecting **Simulate/Pause** while the circuit is simulating, pauses both the circuit and the Logic Analyzer. By using the scroll bar at the bottom of the instrument face, you can view the results of the Logic Analyzer at any period from the first instance the trigger condition was met as long as the Logic Analyzer was not reset. If you did reset the Logic Analyzer, you would be able to view the results from the time the instrument was reset and the trigger condition is met.

- To restart the instrument, click **Reset**. This action will clear all information in the instrument and start storing new information from the instance the trigger condition is met after you clicked **Reset**.
- To discard stored data when the logic analyzer is not triggered, click **Stop**. If the logic analyzer is already triggered and displaying data, clicking **Stop** will stop the instrument and allow the simulation to continue. After you have stopped the instrument, you must reset the Logic Analyzer to begin storing data again.
- To clear the logic analyzer’s display, click **Stop**, then **Reset**. Clearing the display does not disrupt the simulation. The instrument will start storing data from the instance the trigger condition is met after you clicked **Reset**.

#### Clock Setup

The clock informs the logic analyzer when to read an input sample. The clock can be internal or external.

➤ To adjust the clock settings:

1. Click **Set** in the **Clock** area of the logic analyzer. The **Clock Setup** dialog box appears.

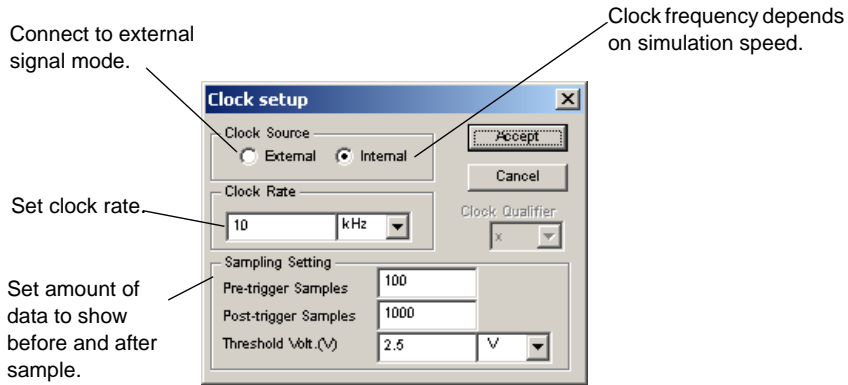

2. Select external or internal clock mode.
3. Set the internal clock rate. The clock qualifier is an input signal that filters the clock signal. If it is set to "x", then the qualifier is disabled and the clock signal determines when samples are read. If it is set to "1" or "0", the samples are read only when the clock signal matches the selected qualifier signal.
4. Set how much data to show before (**Pre-trigger samples**) and after (**Post-trigger samples**) the sample.
5. Click **Accept**.

## Trigger Settings

The logic analyzer can be made to trigger upon reading a specified word or combination of words or when meeting the increase edge or decrease edge of the clock signal.

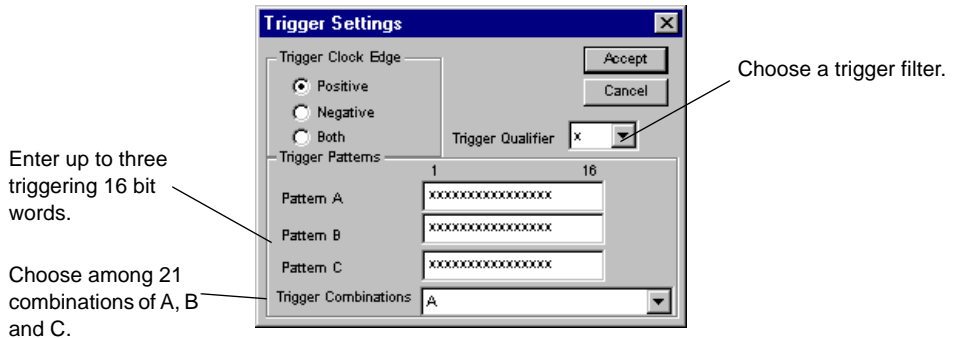

- To specify up to three trigger words or word combinations:
1. Click **Set** in the **Trigger** box of the logic analyzer.
  2. Select **Positive**, **Negative** or **Both** positive and negative clock edge.
  3. Click in the box labeled **Pattern A**, **Pattern B**, or **Pattern C** and enter a binary word. An “x” means either 1 or 0.
  4. From the **Trigger combinations** drop-down list, select the desired combination. (See below for a list of combinations.)
  5. From the **Trigger qualifier** drop-down list, select the desired trigger qualifier. The trigger qualifier is an input signal that filters the triggering signal. If it is set to “x”, then the qualifier is disabled and the trigger signal determines when the logic analyzer is triggered. If it is set to “1” or “0”, the logic analyzer is triggered only when the triggering signal matches the selected trigger qualifier.
  6. Click **Accept**.

The possible trigger combinations are:

A	B	C
A or B	A or C	B or C
A OR B OR C	A AND B	A AND C
B AND C	A AND B AND C	NOT B
A NOT C	B NOT C	A THEN B
A THEN C	B THEN C	(A OR B) THEN C
A THEN (B OR C)	A THEN B THEN C	A THEN (B WITHOUT C)

## 10.11 Logic Converter

To use the instrument, click on the **Logic Converter** button in the **Instrument** toolbar and click to place its icon on the workspace. The icon is used to wire the Logic Converter to the circuit. Double-click on the icon to open the instrument face, which is used to enter settings and view measurements.

The logic converter is able to perform several transformations of a circuit representation or digital signal. This is a useful tool for digital circuit analysis, but has no real-world

counterpart. It can be attached to a circuit to derive the truth table or Boolean expression the circuit embodies, or to produce a circuit from a truth table or Boolean expression.

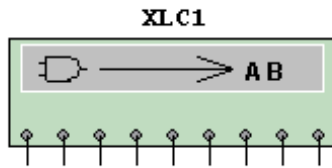

**Logic Converter-XLC1**

Inputs: A B C D E F G H

Truth table for specified inputs:

	A	B	C	D	E	F	G	H
000	0	0			0			?
001	0	0			1			?
002	0	1			0			?
003	0	1			1			?
004	1	0			0			?
005	1	0			1			?
006	1	1			0			?
007	1	1			1			?

Boolean expression:

Conversion options:

- AND → i o | i
- i o | i → AND
- i o | i SIMP → AND
- AND → i o | i
- AND → AND
- AND → NAND

Click to change from 0 to 1 or X (toggle). See details in “Entering and Converting a Boolean Expression” on page 10-37.

- Click the circles or the labels below them to display the inputs for that terminal.
- Note** If you are not familiar with connecting and adjusting the settings of the instruments, see “10.1.2 Adding an Instrument to a Circuit” on page 10-5 and “10.1.3 Using the Instrument” on page 10-5 before using this instrument.

## 10.11.1 Using the Logic Converter

### 10.11.1.1 Logic Converter Settings

#### Deriving a Truth Table from a Circuit

- To derive a truth table from a circuit schematic:
  1. Attach the input terminals of the logic converter to up to eight nodes in the circuit.
  2. Connect the single output of the circuit to the output terminal in the **Logic Converter** icon.

3. Click the **Circuit to Truth Table**  button. The truth table for the circuit appears in the logic converter's display.

## Entering and Converting a Truth Table

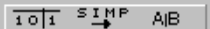

- To construct a truth table:
  1. Click the number of input channels you want, from A to H, across the top of the logic converter. The display area below the terminals fills up with the necessary combinations of ones and zeros to fulfill the input conditions. The values in the output column on the right are initially set to “?”.
  2. Edit the output column to specify the desired output for each input condition.
- To change an output value, click on it to switch among the three possible settings: “0”, “1” and “X” (an “X” indicates that either 1 or 0 is acceptable).
- To convert a truth table to a Boolean expression, click the **Truth Table to Boolean Expression**  button. The Boolean expression is displayed at the bottom of the logic converter.
- To convert a truth table to a simplified Boolean expression, or to simplify an existing Boolean expression, click the **Simplify**  button.

The simplification is performed by the Quine-McCluskey method, rather than the more familiar Karnaugh mapping technique. Karnaugh mapping works for only small numbers of variables and requires human intuition, while Quine-McCluskey has proved to be exhaustive for any number of variables but is too cumbersome for manual solutions.

**Note** Simplifying a Boolean expression requires substantial memory. If sufficient memory is not available, Multisim may not be able to complete this operation.

## Entering and Converting a Boolean Expression

A Boolean expression can be entered in the box at the bottom of the logic converter using either sum-of-products or product-of-sums notation.

- To convert a Boolean expression to a truth table, click the **Boolean Expression to Truth Table**  button.
- To convert a Boolean expression to a circuit, click the **Boolean Expression to Circuit**  button.

The logic gates that fulfill the Boolean expression appear on the circuit window. The components are selected so you can move them to a different location on the circuit window or put them in a subcircuit. Deselect the components by clicking on an empty spot on the circuit.

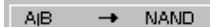
- To see a circuit that fulfills the conditions of the Boolean expression using only NAND gates, click the **Boolean Expression to NAND**  button.

**Note** The width of the wire in the resulting circuit is determined by the **Wire Width** setting in the **Wiring** tab of the **Preferences** dialog box.

## 10.12 Distortion Analyzer

To use the instrument, click on the **Distortion Analyzer** button in the **Instrument** toolbar and click to place its icon on the workspace. The icon is used to wire the Distortion Analyzer to the circuit. Double-click on the icon to open the instrument face, which is used to enter settings and view measurements.

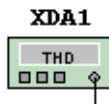

A typical distortion analyzer provides distortion measurements for signals in the range of 20 Hz to 100 kHz, including audio signals.

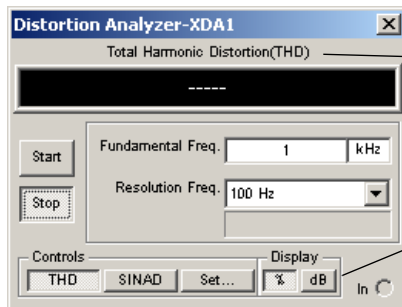

This label changes depending on which type of measurement is selected.

Units used to present results.



The types of measurements performed are either Total Harmonic Distortion (THD) or Signal Plus Noise and Distortion (SINAD). To set the way results are to be displayed for either type of measurement, click **Set**.

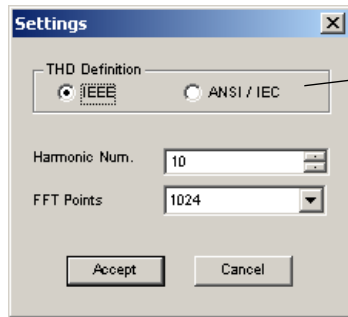

For THD only - sets the definition used to calculate THD (IEEE defines this slightly differently from ANSI/IEC).

**Note** If you are not familiar with connecting and adjusting the settings of the instruments, see “10.1.2 Adding an Instrument to a Circuit” on page 10-5 and “10.1.3 Using the Instrument” on page 10-5 before using this instrument.

## 10.12.1 Using the Distortion Analyzer

### 10.12.1.1 Distortion Analyzer Settings

#### Harmonic Distortion

Harmonic distortion produces signals at harmonics of the test frequency. For example, for a 1 kHz signal, the harmonics may be at 2 kHz, 3 kHz, 4 kHz, etc.

A very sharp tunable notch is required to measure harmonic distortion. This is tuned to the test frequency such as 1 kHz, which will remove the 1 kHz signal, leaving only the harmonics or the distortion. The distortion harmonics are measured and the resulting value is compared to the amplitude of the test signal.

#### SINAD

This type of measurement measures the ratio of (signal plus noise and distortion)/(noise and distortion).

## 10.13 Spectrum Analyzer



The spectrum analyzer is used to measure amplitude versus frequency. It performs a similar function in the frequency domain as an oscilloscope performs in the time domain. It operates by sweeping through a range of frequencies. The amplitude of the signal at the input of the receiver is plotted against the frequency of the signal. This instrument is capable of measuring a signal's power at various frequencies, and helps determine the existence of the frequency components' signal.

The spectrum analyzer is part of the RF Design Module. For more details, see “15.3 RF Instruments” on page 15-9.

**Note** If you are not familiar with connecting and adjusting the settings of the instruments, see “10.1.2 Adding an Instrument to a Circuit” on page 10-5 and “10.1.3 Using the Instrument” on page 10-5 before using this instrument.

## 10.14 Network Analyzer



The network analyzer is used to measure the scattering parameters (or S-parameters) of a circuit, commonly used to characterize a circuit intended to operate at higher frequencies. These S-parameters are used to derive matching cells using other Multisim analyses. The network analyzer also calculates H, Y, Z parameters.

The circuit is idealized as a two-port network. To properly use the network analyzer, the circuit must be left open at its input and output ports. During simulation the network analyzer completes the circuit being analyzed by inserting its subcircuits. You need to remove these subcircuits from the circuit before performing other analysis and simulation.

The network analyzer is part of the RF Design Module. For more details, see “15.3 RF Instruments” on page 15-9.

**Note** If you are not familiar with connecting and adjusting the settings of the instruments, see “10.1.2 Adding an Instrument to a Circuit” on page 10-5 and “10.1.3 Using the Instrument” on page 10-5 before using this instrument.

## 10.15 Measurement Probe

Using the **Measurement Probe** is a fast and easy way to check voltage and frequency readings on different nodes and pins.

The **Measurement Probe** can be used as a:

- **Dynamic Probe** — the circuit is simulated and the probe is dragged to point to any wire to

obtain an “on-the-fly” reading.

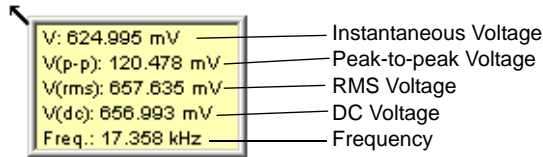

- Placed Probe** — multiple probes can be connected to points in the circuit before or during simulation. These probes remain stationary, and will contain the data from the simulation until another simulation is run, or the data is cleared. In addition to the various voltage readings and the frequency reading found in dynamic probes, placed probes can also include various current readings as shown below.

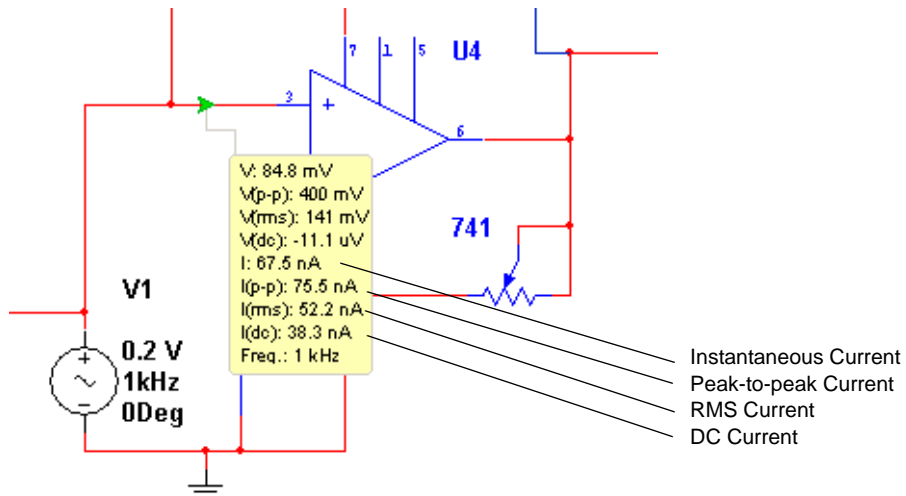

- Note** Dynamic probes cannot display current; probes placed after simulation has run also cannot measure current. This is because the SPICE netlist must be modified in order to measure current, and this is only done when the simulation is restarted.

## 10.15.1 Using the Measurement Probe

### 10.15.1.1 Measurement Probe Settings

The set-up for the **Measurement Probe** is done in the **Probe Properties** dialog box.

- To set up the probe properties:
  1. Select **Simulate/Probe Properties** and click on the **Display** tab.

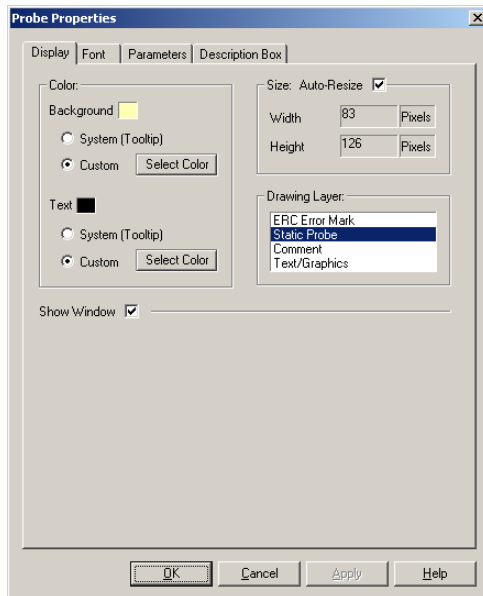

2. Optionally, set the **Background** and **Text** colors in the **Color** box.

**Note** “Tooltip” refers to the text that appears attached to the cursor if you hover it above a tool button.

3. In the **Size** box, enter the **Width** and **Height**, or enable **Auto-Resize** to have the information box automatically resize to show all content.

4. Optionally, click on the **Font** tab to change the font used in the probe's information box.

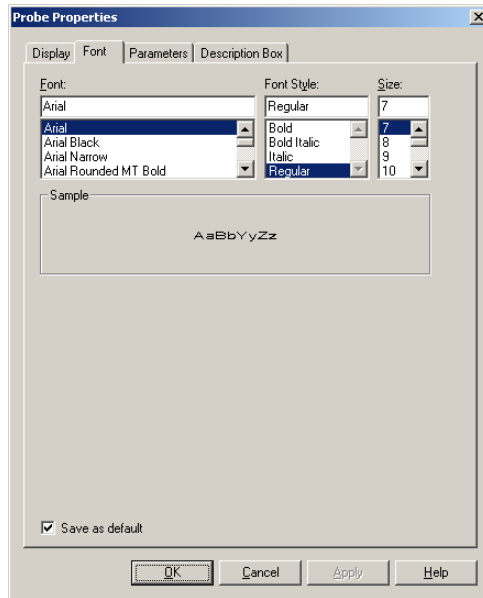

5. Click on the **Parameters** tab.

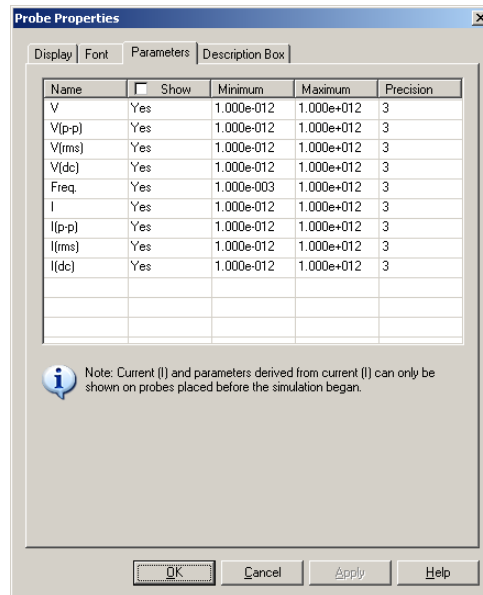

6. To hide a parameter (for example,  $V(p-p)$ ), click beside the desired parameter in the **Show** column to toggle to No.
7. Use the **Minimum** and **Maximum** columns to set a parameter's range.
8. Optionally, change the number of significant digits for a displayed parameter in the **Precision** column.

**Note** These settings are the defaults for any newly placed probes, as well as for the dynamic probe.

### 10.15.1.2 Viewing Measurement Probe Results

The readings for the probe are viewed directly on the screen as shown in “10.15 Measurement Probe” on page 10-40.

### 10.15.1.3 Connecting the Measurement Probe

#### Dynamic Probe

- To use the **Measurement Probe** dynamically (i.e., not placed at one point) and take a reading:
1. Select **Simulate/Run** or click on the **Run/Stop Simulation** button to activate the circuit.
  2. Click on the **Measurement Probe** button found in the **Instruments** toolbar. The probe is now attached to the mouse cursor.
  3. Hover the probe on the point where you wish to take the measurement. The readings appear on the **Measurement Probe**.

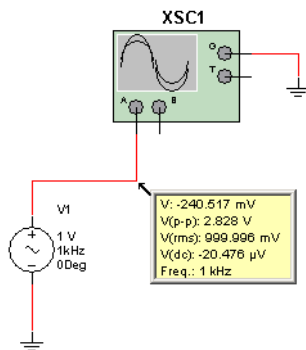

4. When the circuit is simulating, and the probe is not placed on a wire or terminal, it appears as follows:

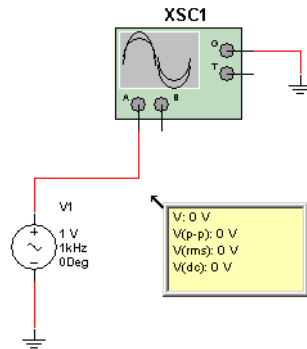

5. To de-activate the probe, click on the **Measurement Probe** button or press ESC.

**Note** For accuracy of measurement, your circuit must have a ground attached, even if it uses a floating power supply.

## Placed Probe

- To connect a placed **Measurement Probe** and take a reading:



1. Click on the **Measurement Probe** button found in the **Instruments** toolbar.
2. Click to place the probe at the desired point on the circuit.

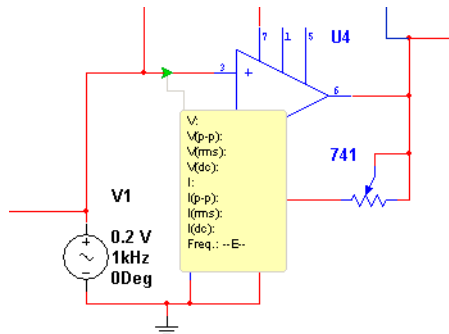

3. Select **Simulate/Run** or click on the **Run/Stop Simulation** button to activate the circuit.
4. The information box is populated with data.

- To hide the contents of the probe:
  1. Right-click on the probe and click on **Show Comment/Probe**. The placed probe now appears as an arrow, as shown below.

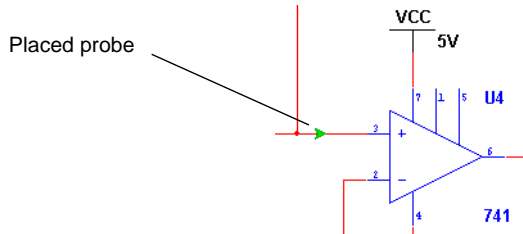

- To show the contents of probe, right-click on it and click on **Show Comment/Probe**.
- To change the properties of a placed probe:
  1. Double-click on the probe to display the **Probe Properties** dialog box.

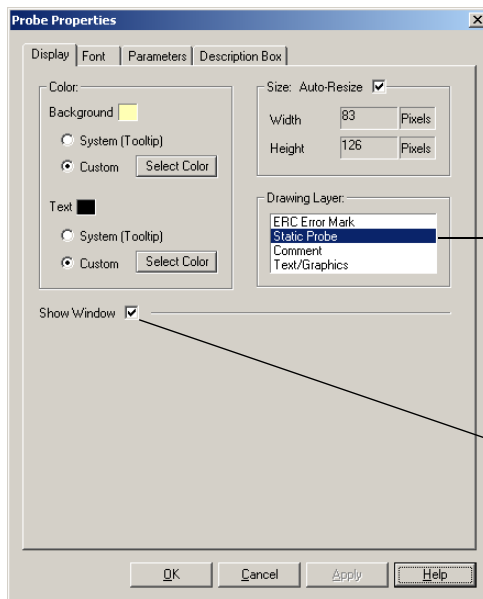

Layer on which the placed probe appears. Select a different layer if desired. For details on layers, see “3.4.2.6 Sheet Properties - Visibility Tab” on page 3-33.

De-select to hide the contents of the placed probe.

2. Optionally, change the probe’s font and parameters as detailed in “10.15.1.1 Measurement Probe Settings” on page 10-42.



## 10.16 Four-channel Oscilloscope



The four-channel oscilloscope allows for the simultaneous monitoring of up to four different inputs.

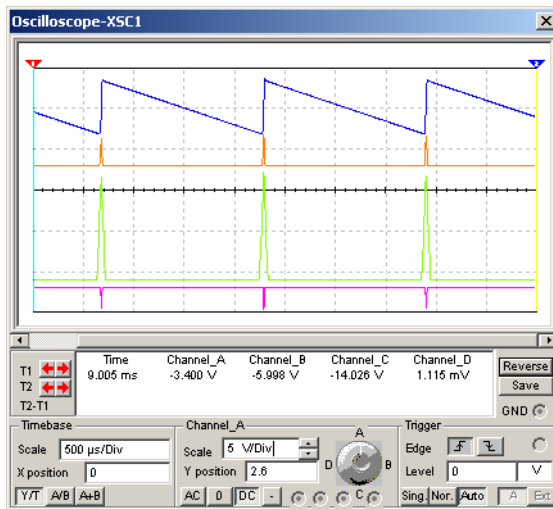
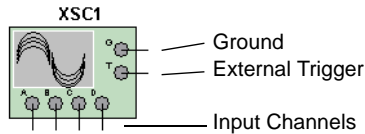

To use the instrument, click on the **Four Channel Oscilloscope** button in the **Instrument** toolbar and click to place its icon on the workspace. The icon is used to wire the Four Channel Oscilloscope to the circuit. Double-click on the icon to open the instrument face, which is used to enter settings and view measurements.

**Note** If you are not familiar with connecting and adjusting the settings of the instruments, see “10.1.2 Adding an Instrument to a Circuit” on page 10-5 and “10.1.3 Using the Instrument” on page 10-5 before using this instrument.

## 10.16.1 Using the Four-channel Oscilloscope

### 10.16.1.1 Four-channel Oscilloscope Settings

Either before, after or during a simulation, you can change the settings that are found at the bottom of the scope. In some cases, you may need to re-run the simulation to achieve accurate results.

➤ To change the settings:

1. Adjust the settings in the **Timebase** box as follows:

- **Scale** field—click in this field to change the scale of the scope's horizontal (x-axis) when comparing magnitude against time (**Y/T**) or adding signals, for example, **A+B** (see Axes buttons below).
- **X position** field—click in this field to change the signal's starting point on the x-axis. When set to 0, the signal starts at the left edge of the display. A positive value (for example, 2.00) shifts the starting point to the right, in this case two divisions. A negative value (for example, -3.00) shifts the starting point to the left, in this case three divisions.
- **Axes buttons**—

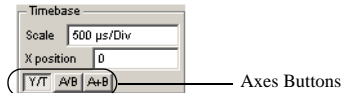

**Y/T**—click to display waveform magnitude (y-axis) against time (x-axis).

**A/B**—click to show input channel A against input channel B. (A is on the y-axis and B is on the x-axis). These settings display frequency and phase shifts, known as Lissajous patterns, or they can display a hysteresis loop. When this button is selected, the **Scale** and **X position** fields are disabled (greyed out).

You can change the channels that are represented on the y-axis and x-axis by right-clicking on the **A/B** button to display a pop-up menu. Remember that the first letter is the channel that is represented on the y-axis and the second letter is the channel that is represented on the x-axis. Once you have selected an item from the menu, the **A/B** button's label will change to reflect your selection. For example, if you

select **D/A**, the button will read **D/A**.

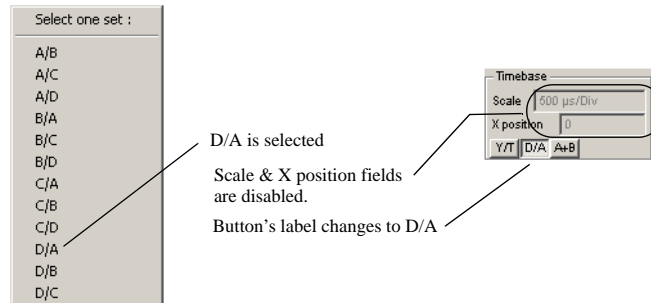

**A+B**—click to add trace A to trace B.

You can change the channels that are added together by right-clicking on the A+B button and making a selection from the pop-up menu that appears.

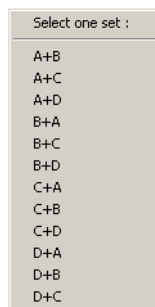

## 2. Adjust the settings in the **Channel\_A** box as follows:

- **Channel dial**—click and drag on the dial to select the input channel that is being set in the **Scale** and **Y position** fields and input coupling buttons. Note that the name of the box changes as you move the dial.

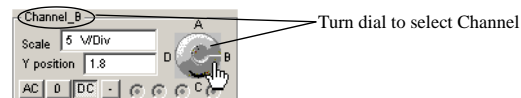

- **Scale field**—click here to change the number of volts per division. This setting determines the scale of the y-axis. It also controls the x-axis scale when the **A/B** button is selected in the **Timebase** box.

**Note** When running a simulation, the **Scale** selected in the channel that is displayed is the scale that is used on the graph. For example, if you have selected Channel B with the channel dial, and its **Scale** is set to 5 V/Div, all channels in the graph will be shown at 5 V/Div, even if channels A, C & D are set to 2 V/Div.

- **Y position** field—click in this field to change the signal’s starting point on the y-axis. When set to 0, the signal starts at the intersection with the x-axis. A positive value (for example, 2.00) shifts the starting point above the x-axis, in this case two divisions. A negative value (for example, -3.00) shifts the starting point below the x-axis, in this case three divisions. Using a different **Y position** setting for each trace (channel) helps distinguish individual waveforms.
- Input coupling buttons:



**AC** button—click to display only the AC component of a signal. This has the effect of placing a capacitor in series with the oscilloscope’s probe. As on a real oscilloscope using AC coupling, the first cycle displayed is inaccurate. Once the signal’s DC component has been calculated and eliminated in the first cycle, the waveforms are accurate.

**0** button—click to display a flat reference line at the point of origin set in **Y position**.

**DC** button—click to display the sum of the AC and DC components of the signal.

**-** button—click to invert the selected channel’s trace 180 degrees.

**Note** Do not place a coupling capacitor in series with an oscilloscope probe. The oscilloscope will not provide a path for current and the analysis will consider the capacitor improperly connected. Instead, choose **AC**.

3. Adjust the settings in the **Trigger** box as follows:

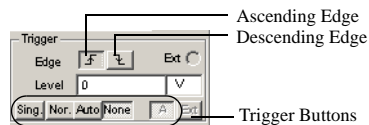

- **Edge** buttons—click the Ascending Edge button to start displaying the signal on its positive slope or rising signal. Click the Descending Edge button to start with the negative slope or falling signal.
- **Level** fields—enter the trigger level in the left field and the unit of measure in the right field. The trigger level is the point on the y-axis that must be crossed by the waveform before it is displayed. A flat waveform will not cross the trigger level. To see a flat signal, make sure the triggering signal is set to **Auto**.
- Trigger buttons:
  - Sing** (single) button—click to make the scope trigger one pass when the trigger level is met. Once the trace gets to the end of the scope face, it will not change until you click **Sing** again.

**Nor** (normal) button—click to make the scope refresh every time the trigger level is met.

**Auto** (automatic) button—click to display a flat signal, or if you wish to display signals as soon as possible. If **Auto** is selected, the **A** and **Ext** buttons are disabled (greyed out).

**A** button—this is active if **Sing** or **Nor** are selected. If selected, triggering is internal with reference to channel A. If you wish to change the internal reference channel, right-click on **A** to display a pop-up menu and select the desired channel. The label on the button changes to reflect your selection.

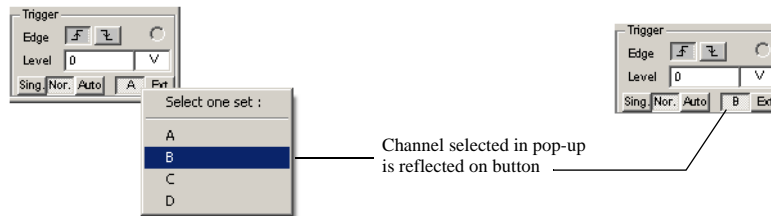

**None** button — to have no trigger setting

**Ext** (external) button—click if you wish to trigger the scope from an external source.

4. Optionally, click on **Save** to save the results in one of the following file formats:

- Scope data (\* .scp) — Multisim oscilloscope format file.
- LabVIEW measurement files (\* .lvnm) — files created in National Instruments LabVIEW.
- DIAdem files (\* .tdm) — files created in National Instruments DIAdem. Note that when you save data as a DIAdem file, two files are created; a header file (.tdm) and a binary file (.tdx).

**Note** Along with the Save button found in the oscilloscope, you can also save simulation results from the **Grapher** window. For details, see “11.2.5 Opening and Saving Files” on page 11-21.

## 10.16.1.2 Viewing Four-channel Oscilloscope Results

This section uses the following circuit to demonstrate the use of the four-channel oscilloscope. This circuit is a sawtooth waveform generator with the scope attached to four different points.

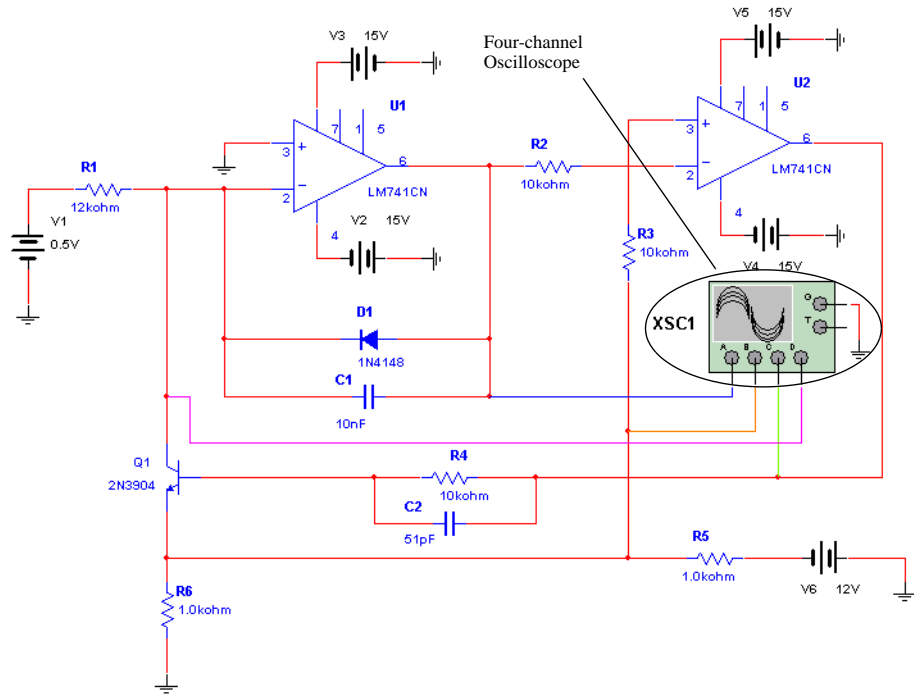

### Taking Readings

- To take readings with the four-channel oscilloscope:

1. Select **Simulate/Run** or click on the **Run/Stop Simulation** button to activate the circuit.
2. Double-click on the four-channel oscilloscope's icon to open the instrument face.

**Note** You may open the instrument at any time before, during or after the simulation is run.

3. After a few seconds, either stop or pause the simulation. Optionally, click **Reverse** to show the display with a white background. The four traces on the oscilloscope's display represent the four input channels A through D. The traces have the same colors that were

selected for their wires in “10.16.1.3 Connecting the Four-channel Oscilloscope” on page 10-55.

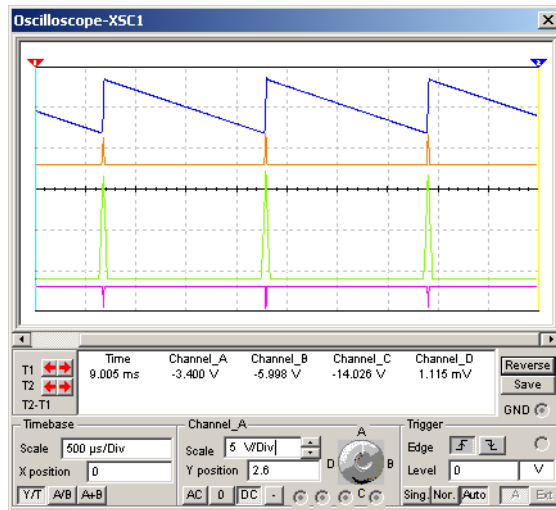

**Note** It is not necessary to stop or pause the simulation to view data or change the scope’s settings.

## Viewing Data

Either before, after or during a simulation, you can change the data viewing settings.

- To view data on the four-channel oscilloscope screen:
  1. Place the mouse cursor over the left graph cursor (labeled “1”) and drag the graph cursor to a point on the curves. Note that the data in the **T1** section of the scope change to reflect the points where the cursor crosses the curves. You may also drag the right graph cursor

(labeled “2”) to a desired point on the curves. When you do this the data in the **T2** row of the scope change.

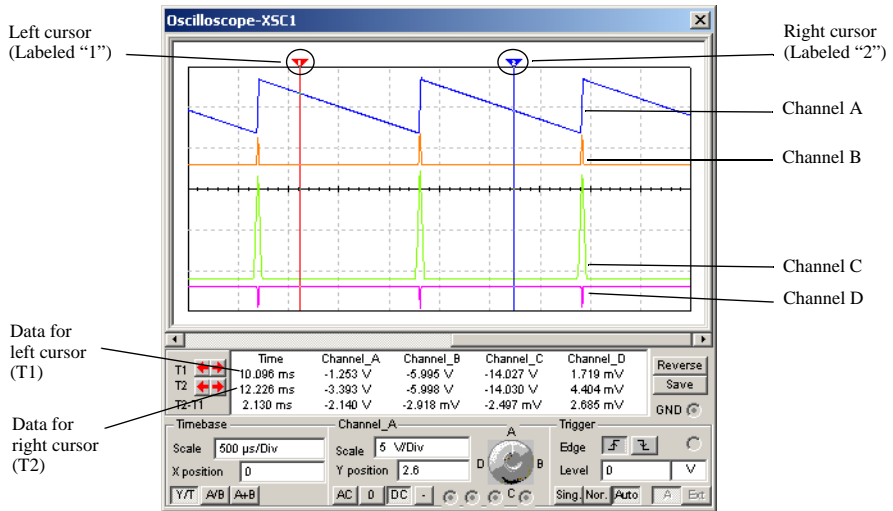

2. You may also use the left and right arrows to move the graph cursor.

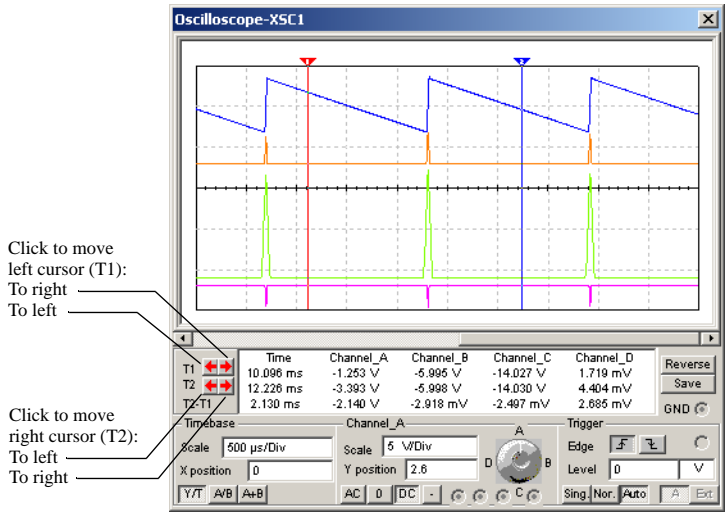



- You can also move either graph cursor to a specific x or y value on the selected curve by right-clicking on it to display a pop-up menu.

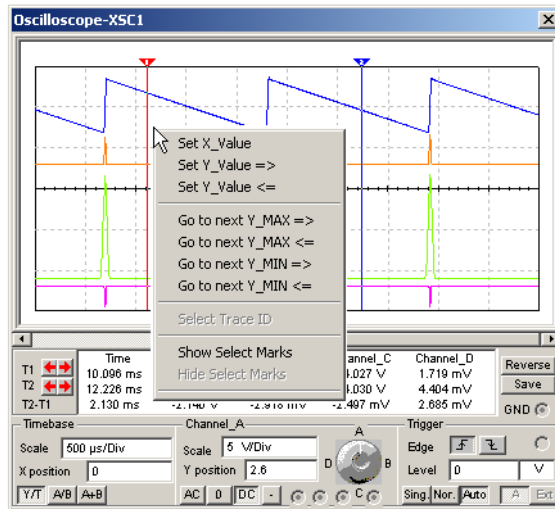

**Note** For details, see “11.2.2.3 Cursor Pop-up Menu” on page 11-11.

### 10.16.1.3 Connecting the Four-channel Oscilloscope

- To connect the four-channel oscilloscope:



- Click on the **4 Channel Oscilloscope** tool button and place the instrument in the desired location in your circuit.
- Wire the oscilloscope to the desired points in your circuit, following the Pin Map below.

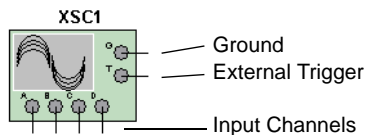

- Select different colors for the wires leading to the four input channels to the oscilloscope. The traces of the four channels that appear on the oscilloscope will be represented by the colors chosen in this step.
  - Right-click on the wire leading to input channel A and select **Segment Color** from the

pop-up that appears.

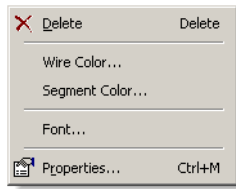

The **Color** dialog box appears.

- Click on the desired color for the wire and click **OK**.
- Repeat for channels B - D.

You now have a circuit with the four-channel oscilloscope connected in a fashion similar to the following.

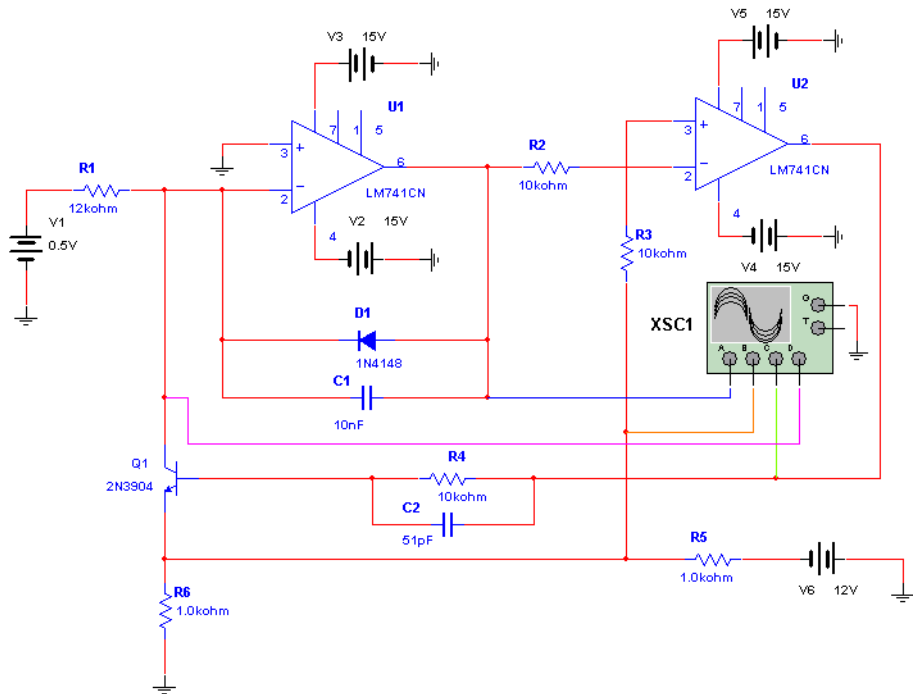

## 10.17 Frequency Counter

The frequency counter is used to measure signal frequency.

To use the instrument, click on the **Frequency Counter** button in the **Instrument** toolbar and click to place its icon on the workspace. The icon is used to wire the Frequency Counter to the circuit. Double-click on the icon to open the instrument face, which is used to enter settings and view measurements.

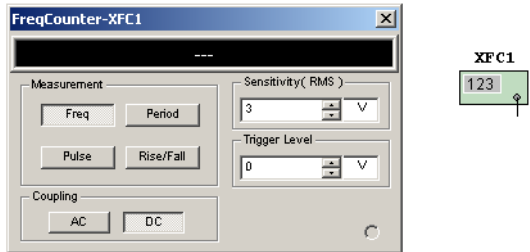

**Note** If you are not familiar with connecting and adjusting the settings of the instruments, see “10.1.2 Adding an Instrument to a Circuit” on page 10-5 and “10.1.3 Using the Instrument” on page 10-5 before using this instrument.

### 10.17.1 Using the Frequency Counter

- To measure a circuit using the frequency counter:
  1. Click on the **Frequency Counter** tool button and place the icon in the desired location in your circuit. Wire the frequency counter to the point in the circuit that you wish to measure.

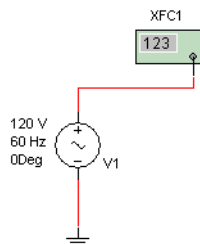

**Note** This example uses a simple AC source to provide a signal to the Frequency Counter.

2. Double-click on the icon to open the instrument face. Note that the **Freq** (frequency) button is currently selected.

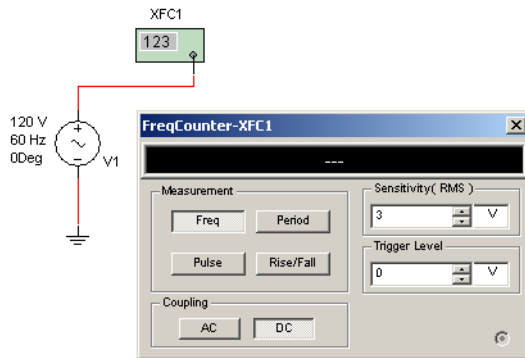

3. Set the instrument to read as desired, using the following controls:
  - **Measurement box:**
    - Freq** (frequency) button—click to measure the frequency.
    - Pulse** button—click to measure the duration of a positive and negative pulse.
    - Period** button—click to measure the duration of a single cycle.
    - Rise/Fall** button—click to measure the rise and fall times of a single cycle.
  - **Coupling box:**
    - AC** button—click to display only the AC component of a signal.
    - DC** button—click to display the sum of the AC and DC components of the signal.
  - **Sensitivity (RMS)** box—enter the sensitivity in the left field and the unit of measure in the right field.
  - **Trigger Level** box—enter the trigger level in the left field and the unit of measure in the right field. The trigger level is the point that must be reached by the waveform before a reading is displayed.

**Note** The above settings may be changed before, during or after a simulation.

4. Select **Simulate/Run**. Since the **Freq** button is selected, the frequency at the point where the frequency counter is connected displays.

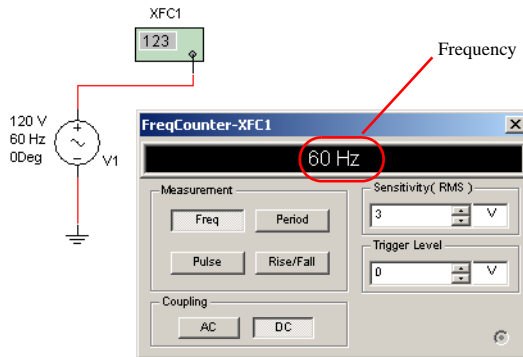

5. Other readings may be observed as follows:

- Pulse

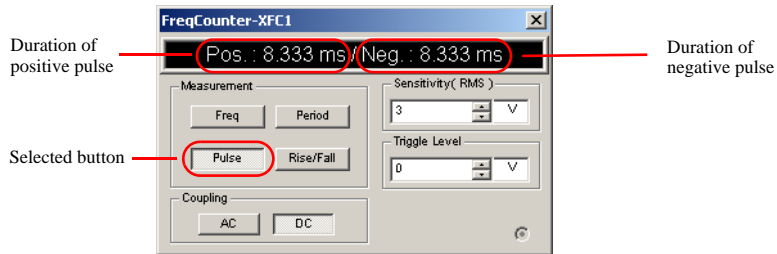

- Period

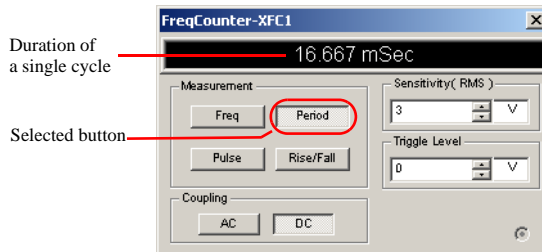

- Rise/Fall

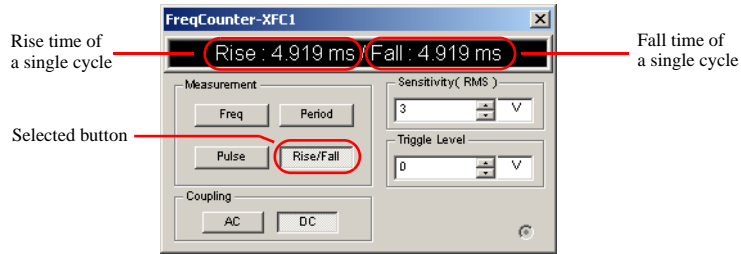

## 10.18 IV Analyzer



The IV Analyzer is used to measure the current-voltage curves of the following devices:

- Diode
- PNP BJT
- NPN BJT
- PMOS
- NMOS.

**Note** The IV Analyzer measures single components that are not connected in a circuit. You may measure devices that are already in circuits by disconnecting them first.

## 10.18.1 Using the IV Analyzer

- To use the **IV Analyzer** to measure a device's characteristics:
  1. Click on the **IV Analysis** tool button, place its icon on the workspace and double-click on the icon to open the instrument.
  2. Select the type of device that you are analyzing from the **Components** drop-down list, for example PMOS.

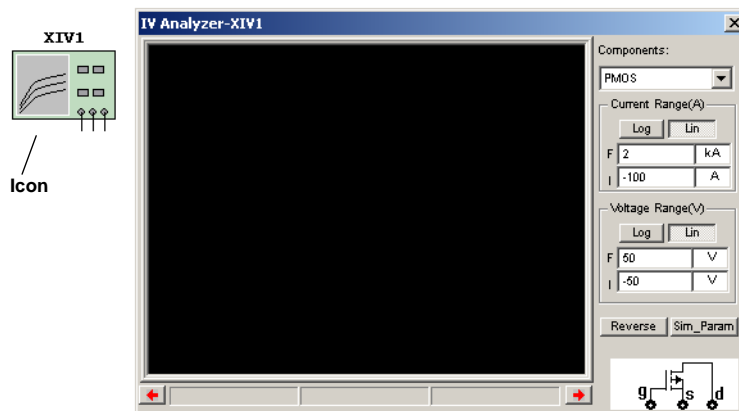

**Note** A PMOS FET is analyzed in this example.

3. Place the desired device on the workspace and wire it to the IV Analyzer following the symbol map that is shown on the instrument face.

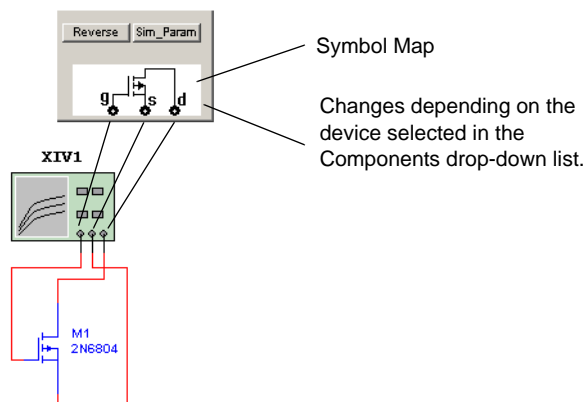

**Note** If checking a device that is already in a circuit, disconnect it from the circuit and attach it to the IV Analyzer as shown above.

4. Click **Sim\_Param** to display the **Simulate Parameters** dialog box.

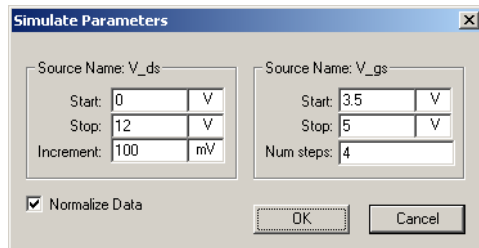

**Note** The contents of this dialog box change depending on the device selected in the **Components** drop-down list. For details on how this dialog box appears for other devices, see “10.18.1.1 Simulate Parameters Dialog Box” on page 10-63.

Optionally, change the default settings for  $V_{ds}$  (drain-source voltage) that appear in the following fields in the **Source Name:  $V_{ds}$**  box:

- **Start**—enter the desired start  $V_{ds}$  for the sweep in the left section and the unit of measure in the right section
- **Stop**—enter the desired stop  $V_{ds}$  for the sweep in the left section and the unit of measure in the right section
- **Increment**—enter the desired size of the steps of  $V_{ds}$  for the sweep in the left section and the unit of measure in the right section. The points formed by these steps will be the points at which measurements will be calculated to form the curve(s) on the graph.

Optionally, change the default settings for  $V_{gs}$  (gate-source voltage) that appear in the following fields in the **Source Name:  $V_{gs}$**  box:

- **Start**—enter the desired start  $V_{gs}$  for the sweep in the left section and the unit of measure in the right section
- **Stop**—enter the desired stop  $V_{gs}$  for the sweep in the left section and the unit of measure in the right section
- **Num steps**—enter the desired number of steps of  $V_{gs}$  for the sweep. There will be one curve for each value of  $V_{gs}$ .

**Normalize Data** checkbox—displays the  $V_{ds}$  values in the curves (x-axis) with positive values.

Click **OK** to save the settings and return to the main IV Analyzer dialog box.

5. Optionally, change the default scale buttons in the **Current Range(A)** and **Voltage Range(V)** boxes from **Lin** (linear) to **Log** (logarithmic). In this example, both settings were left at **Lin**.

**Note** There is no need to change the **F** (final) and **I** (initial) current and voltage settings. After the simulation is run, these fields are populated so that the curves fully display.



See “10.18.2 Reviewing IV Analyzer Data” on page 10-67 for details on changing these fields to view specific areas of the curve.

6. Select **Simulate/Run**. The IV curves for the device are displayed. If desired, click on **Reverse** to change the display to a white background.

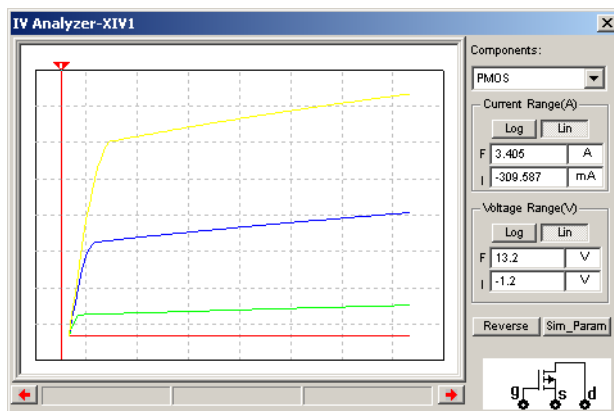

**Note** See also “10.18.2 Reviewing IV Analyzer Data” on page 10-67.

7. Optionally, select **View/Grapher** to view the results of the simulation on the grapher.

### 10.18.1.1 Simulate Parameters Dialog Box

The **Simulate Parameters** dialog box, which is described in step 4 above, changes depending on the device selected in the **Components** drop-down list. This section describes the data that appear in the dialog box when other component types are selected.

#### Diode Parameters

When you have selected Diode in the **Components** drop-down list of the **IV Analyzer** dialog box and clicked **Sim\_Param.**, the **Simulate Parameters** dialog box that appears is populated with the following data.

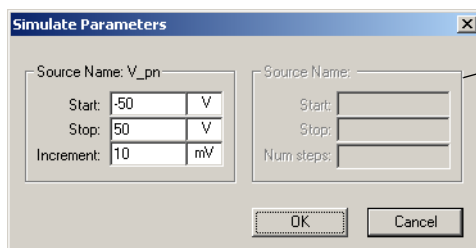

This box is disabled for diode measurements

Optionally, change the default settings that appear in the following fields in the **SourceName: V<sub>pn</sub>** box:

- **Start**—enter the desired start  $V_{pn}$  for the sweep in the left section and the unit of measure in the right section
- **Stop**—enter the desired stop  $V_{pn}$  for the sweep in the left section and the unit of measure in the right section
- **Increment**—enter the desired size of the steps of  $V_{pn}$  for the sweep in the left section and the unit of measure in the right section. The points formed by these steps will be the points at which measurements will be calculated to form the curve on the graph.

## PNP BJT Parameters

When you have selected BJT PNP in the **Components** drop-down list of the **IV Analyzer** dialog box and clicked **Sim\_Param.**, the **Simulate Parameters** dialog box that appears is populated with the following data.

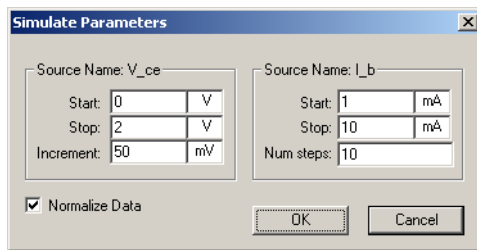

Optionally, change the default parameters for  $V_{ce}$  (collector-emitter voltage) that appear in the following fields in the **Source Name: V<sub>ce</sub>** box:

- **Start**—enter the desired start  $V_{ce}$  for the sweep in the left section and the unit of measure in the right section
- **Stop**—enter the desired stop  $V_{ce}$  for the sweep in the left section and the unit of measure in the right section
- **Increment**—enter the desired size of the steps of  $V_{ce}$  for the sweep in the left section and the unit of measure in the right section. The points formed by these steps will be the points at which measurements will be calculated to form the curve(s) on the graph.

Optionally, change the default parameters for  $I_b$  (base current) that appear in the following fields in the **Source Name: I<sub>b</sub>** box:

- **Start**—enter the desired start  $I_b$  for the sweep in the left section and the unit of measure in the right section
- **Stop**—enter the desired stop  $I_b$  for the sweep in the left section and the unit of measure in the right section
- **Num steps**—enter the desired number of steps of  $I_b$ . There will be one curve for each

- value of  $I_b$ .
- **Normalize Data** checkbox—displays the  $V_{ce}$  values on the curves (x-axis) with positive values.

## NPN BJT Parameters

When you have selected BJT NPN in the **Components** drop-down list of the **IV Analyzer** dialog box and clicked **Sim\_Param.**, the **Simulate Parameters** dialog box that appears is populated with the following data.

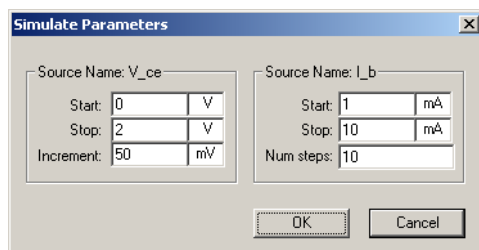

Optionally, change the default settings parameters for  $V_{ce}$  (collector-emitter voltage) that appear in the following fields in the **Source Name: V<sub>ce</sub>** box:

- **Start**—enter the desired start  $V_{ce}$  for the sweep in the left section and the unit of measure in the right section
- **Stop**—enter the desired stop  $V_{ce}$  for the sweep in the left section and the unit of measure in the right section
- **Increment**—enter the desired size of the steps of  $V_{ce}$  for the sweep in the left section and the unit of measure in the right section. The points formed by these steps will be the points at which measurements will be calculated to form the curve(s) on the graph.

Optionally, change the default parameters for  $I_b$  (base current) that appear in the following fields in the **Source Name: I<sub>b</sub>** box:

- **Start**—enter the desired start  $I_b$  for the sweep in the left section and the unit of measure in the right section
- **Stop**—enter the desired stop  $I_b$  for the sweep in the left section and the unit of measure in the right section
- **Num steps**—enter the desired number of steps for  $I_b$ . There will be one curve for each value of  $I_b$ .

## PMOS FET Parameters

See step 4 on page 10-62 for details on the **Simulate Parameter** dialog box when used with a PMOS FET.

## NMOS FET Parameters

When you have selected NMOS in the **Components** drop-down list of the **IV Analyzer** dialog box and clicked **Sim\_Param.**, the **Simulate Parameters** dialog box that appears is populated with the following data.

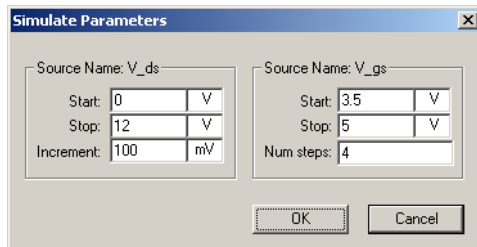

Optionally, change the default parameters for  $V_{ds}$  (drain-source voltage) that appear in the following fields in the **Source Name: V<sub>ds</sub>** box:

- **Start**—enter the desired start  $V_{ds}$  for the sweep in the left section and the unit of measure in the right section
- **Stop**—enter the desired stop  $V_{ds}$  for the sweep in the left section and the unit of measure in the right section
- **Increment**—enter the desired size of the steps of  $V_{ds}$  for the sweep in the left section and the unit of measure in the right section. The points formed by these steps will be the points at which measurements will be calculated to form the curve(s) on the graph.

Optionally, change the default parameters for  $V_{gs}$  (gate-source voltage) that appear in the following fields in the **Source Name: V<sub>gs</sub>** box:

- **Start**—enter the desired start  $V_{gs}$  for the sweep in the left section and the unit of measure in the right section
- **Stop**—enter the desired stop  $V_{gs}$  for the sweep in the left section and the unit of measure in the right section
- **Num steps**—enter the desired number of steps of  $V_{gs}$  for the sweep. The points formed by these steps will be the points at which measurements will be calculated to form the curve(s) on the graph.

## 10.18.2 Reviewing IV Analyzer Data

After you run an IV analysis, you will have a graph similar to the following. Note that the cursor is not on any of the curves and the three fields at the bottom of the graph are empty.

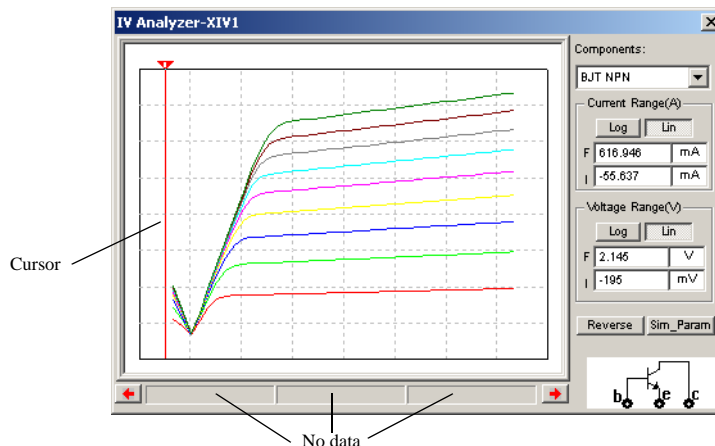

**Note** This section uses data from the analysis of an NPN BJT.

➤ To view data in the **IV Analyzer** dialog box:

1. Place the mouse cursor over the graph cursor and drag the graph cursor to a point on the curves. The three fields at the bottom of the graph now contain data which corresponds to a base current ( $I_b$ ) of 1 mA.  $I_b(1m)$  is represented by the curve at the bottom of the graph.

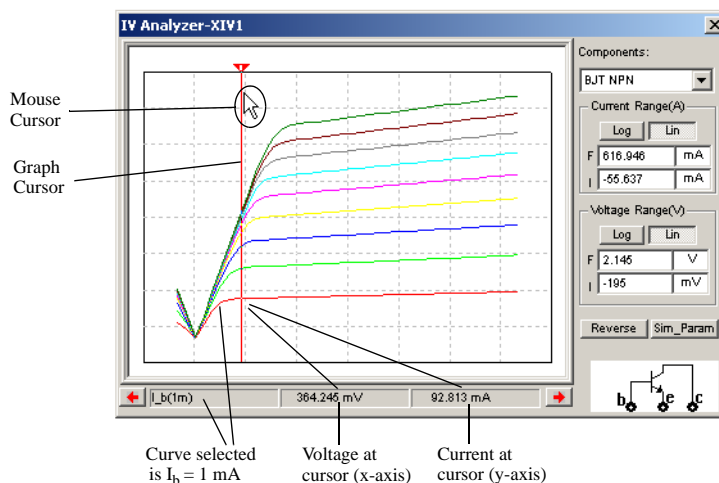

- To select another curve, for example,  $I_b = 2 \text{ mA}$ , click on that curve with your mouse cursor. The fields at the bottom of the graph now contain the data from the point where the graph cursor crosses the selected curve.

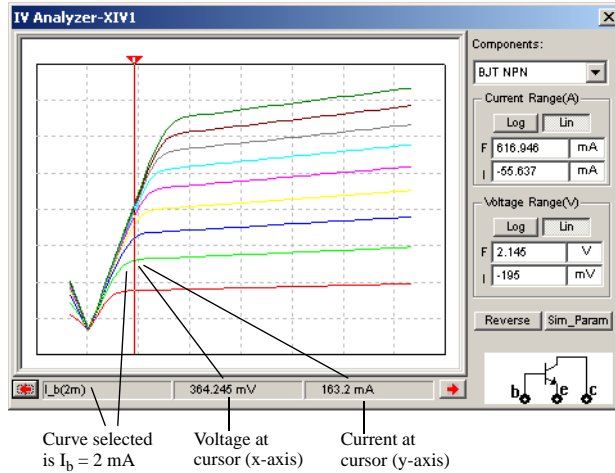

- You may also use the left and right arrows to move the graph cursor, as indicated below.

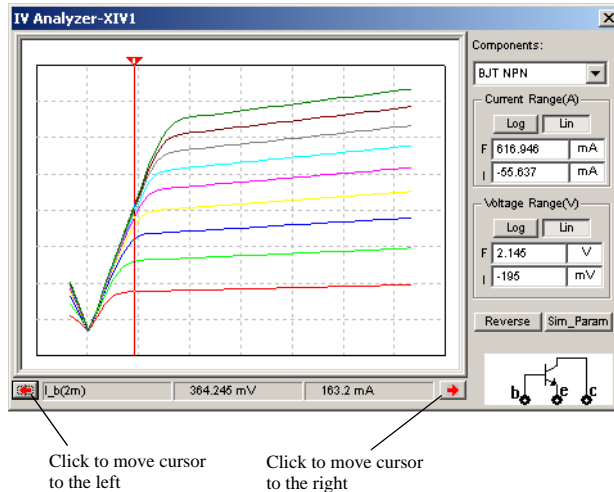

- You can also move the graph cursor to a specific x or y value on the selected curve by right-clicking on it to display a pop-up menu.

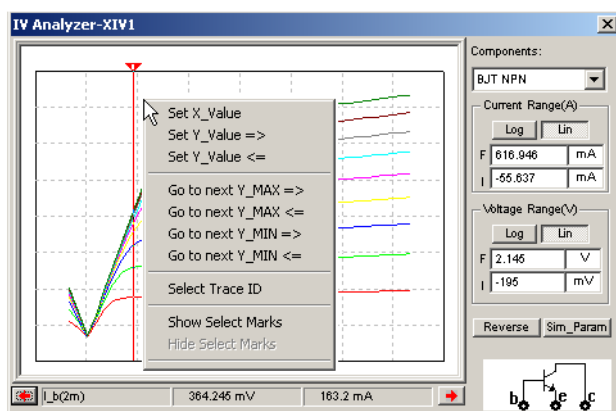

**Note** For details, see “11.2.2.3 Cursor Pop-up Menu” on page 11-11.

- To view specific areas of the graph, change the data in the **Current Range(A)** and **Voltage Range(V)** boxes.

Current Range(A)	
<input type="button" value="Log"/>	<input type="button" value="Lin"/>
F 618.946	mA
I -55.637	mA

Voltage Range(V)	
<input type="button" value="Log"/>	<input type="button" value="Lin"/>
F 2.145	V
I -195	mV

- Current Range(A)** (y-axis)
  - I** field—enter initial current to be displayed on graph in left field and unit of measure in right field
  - F** field—enter final current to be displayed on graph in left field and unit of measure in right field
- Voltage Range(V)** (x-axis)
  - I** field—enter initial voltage to be displayed on graph in left field and unit of measure in right field
  - F** field—enter final voltage to be displayed on graph in left field and unit of measure in right field

6. In the following example, the graph is set to display  $I_b = 2$  mA, from 75 mA to 175 mA on the y-axis; and from 100 mV to 1.25 V on the x-axis.

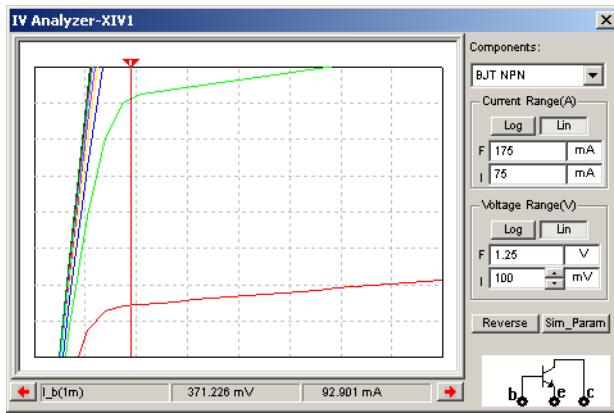

## 10.19 Agilent Simulated Instruments



The following virtual simulated Agilent instruments are included in Multisim 9:

- Function Generator 33120A
- Multimeter 34401A
- Oscilloscope 54622D

**Note** If you are not familiar with connecting and adjusting the settings of the instruments, see “10.1.2 Adding an Instrument to a Circuit” on page 10-5 and “10.1.3 Using the Instrument” on page 10-5 before using this instrument.



## 10.19.1 Agilent Simulated Function Generator



The Agilent Technologies 33120A is a high-performance 15 MHz synthesized function generator with built-in arbitrary waveform capability. A link to the PDF version of this instrument's user guide can be found at [www.electronicworkbench.com](http://www.electronicworkbench.com).

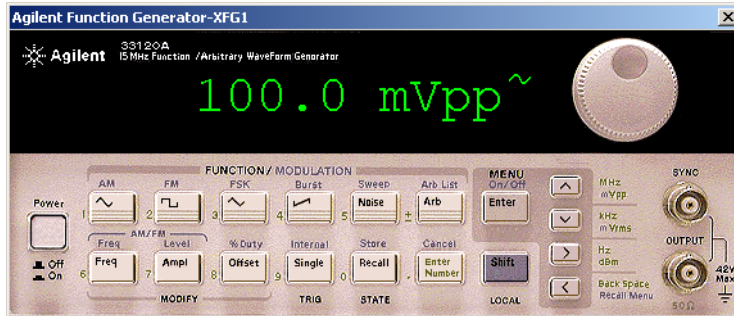

### 10.19.1.1 Supported Features

Most of the features that are documented in the Agilent 33120A User's Guide are available in its virtual simulated version. These include:

Standard Waveforms:	Sine, Square, Triangle, Ramp, Noise, DC volts
System Arbitrary Waveforms:	Sinc, Negative Ramp, Exponential Rise, Exponential Fall, Cardiac
User Defined Arbitrary Waveforms:	Any type of waveform with 8 - 256 points
Modulations:	NON, AM, FM, Burst, FSK, Sweep
Memory Sections:	Four memory sections named #0 - #3. #0 is the system default
Trigger Modes:	Auto/Single for Burst and Sweep modulation only
Display Digital:	4 - 8
Display Voltage:	Three modes: Vpp, Vrms and dBm
Edit Digital Value:	Change the displayed value with cursor buttons or number keys, or use the knob, or use the ENTER NUMBER key to key in the number directly

Menu Operation:

The menu structure is:

A: MODulation MENU

1: AM SHAPE, 2:FM SHAPE, 3:BURST CNT,  
4:BURST RATE, 5:BURST PHAS, 6:FSK  
FREQ, 7:FSK RATE

B:SWP MENU

1:START F, 2:STOP F, 3:SWP TIME, 4:SWP  
MODE,

C:EDIT MENU

1:NEW ARB, 2:POINTS, 3:LINE EDIT,  
4:POINT EDIT, 5:INVERT, 6:SAVE AS,  
7:DELETE

D:SYStem MENU

1:COMMA

### **10.19.1.2Features Not Supported**

The following features are not supported in the simulated version of the function generator included in Multisim:

Remote mode

Terminals on rear panel

Self-test

Hardware error detect

Calibration

### 10.19.1.3 Using the Agilent Function Generator

- To connect the Agilent 33120A Function Generator to a circuit:
  1. Click on the **Agilent Function Generator** tool button, place its icon on the workspace and double-click on the icon to open the instrument. Click on the Power button to switch on the instrument.

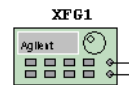
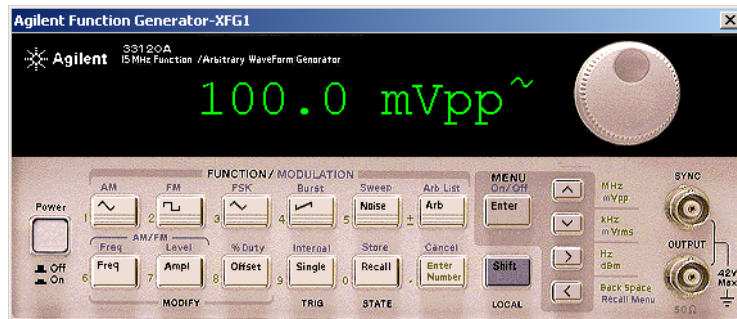

2. Wire the icon to the circuit following the pin key below.

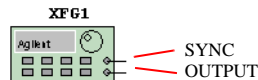

3. Refer to the PDF user guide for complete instructions on the use of this device.

**Note** A link to the PDF version of this instrument's user guide can be found at [www.electronicworkbench.com](http://www.electronicworkbench.com).

## 10.19.2 Agilent Simulated Multimeter

The simulated Agilent Technologies 34401A Multimeter is a 6 1/2-digit, high-performance digital multimeter. A link to the PDF version of this instrument's user guide can be found at [www.electronicsworkbench.com](http://www.electronicsworkbench.com).

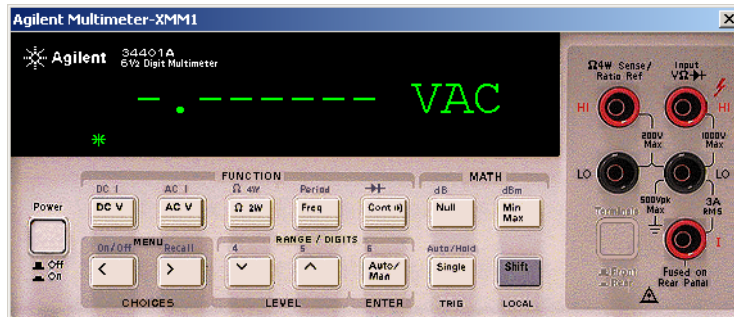

### 10.19.2.1 Supported Features

Most of the features that are documented in the Agilent 34401A User's Guide are available in its virtual version. These include:

Measure Modes:	<ul style="list-style-type: none"> <li>Voltage DC/AC</li> <li>Current DC/AC</li> <li>Resistor in two wires</li> <li>Frequency of input signal's voltage wave</li> <li>Period of input signal's voltage wave</li> <li>Continuity test</li> <li>Diode test</li> <li>Ratio test</li> </ul>
Functions:	<ul style="list-style-type: none"> <li>Null (relative measurement)</li> <li>Min-Max (store minimum and maximum readings)</li> <li>dB (display on voltage value)</li> <li>dBm (display on voltage value)</li> <li>Limit Test (test readings with a lower threshold value and a high threshold value)</li> </ul>
Trigger Modes:	<ul style="list-style-type: none"> <li>Auto/Manual</li> </ul>

Display Modes:	Auto/Manual
Display Digital:	4 1/2 - 6 1/2
Reading Hold:	Yes
Reading Memory:	Yes
Edit Digital Value:	Change the displayed value with cursor buttons or number keys
Menu Operation:	The menu structure is: A: MEASurement MENU 1: CONTINUITY, 2:RATIO FUNC B:MATH MENU 1:MIN-MAX, 2:NULL VALUE, 3: dB REL, 4:dBm REF R, 5:LIMIT TEST, 6:HIGH LIMIT, 7:LOW LIMIT C:TRIGger MENU 1:READ HOLD, 2:TRIG DELAY D:SYStem MENU 1:RDGS STORE, 2:SAVED RDGS, 3:BEEP, 4:COMMA

All other features and operations are based on the Agilent 34401A User's Guide.

### **10.19.2.2 Features Not Supported**

The following features are not supported in the simulated version of the Multimeter included in Multisim.

- Remote mode
- Commands mode
- Terminals on rear panel
- Self-test
- Hardware error detect
- Calibration

### 10.19.2.3 Using the Agilent Multimeter

- To connect the simulated Agilent 34401A Multimeter to a circuit:
  1. Click on the **Agilent Multimeter** tool button, place its icon on the workspace and double-click on the icon to open the instrument. Click on the Power button to switch on the instrument.

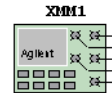
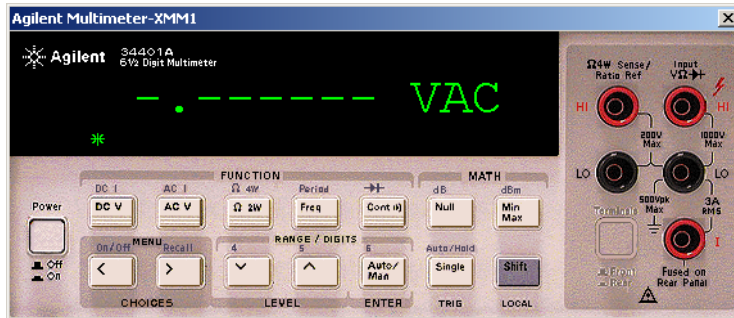

2. Wire the icon to the circuit following the pin key below.

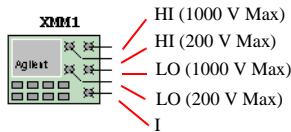

3. Refer to the PDF user guide for complete instructions on the use of this device.

**Note** A link to the PDF version of this instrument's user guide can be found at [www.electronicworkbench.com](http://www.electronicworkbench.com).

## 10.19.3 Agilent Simulated Oscilloscope



The simulated Agilent Technologies 54622D Oscilloscope is a 2-channel +16 logic channels, 100-MHz bandwidth oscilloscope. A link to the PDF version of this instrument's user guide can be found at [www.electronicworkbench.com](http://www.electronicworkbench.com).

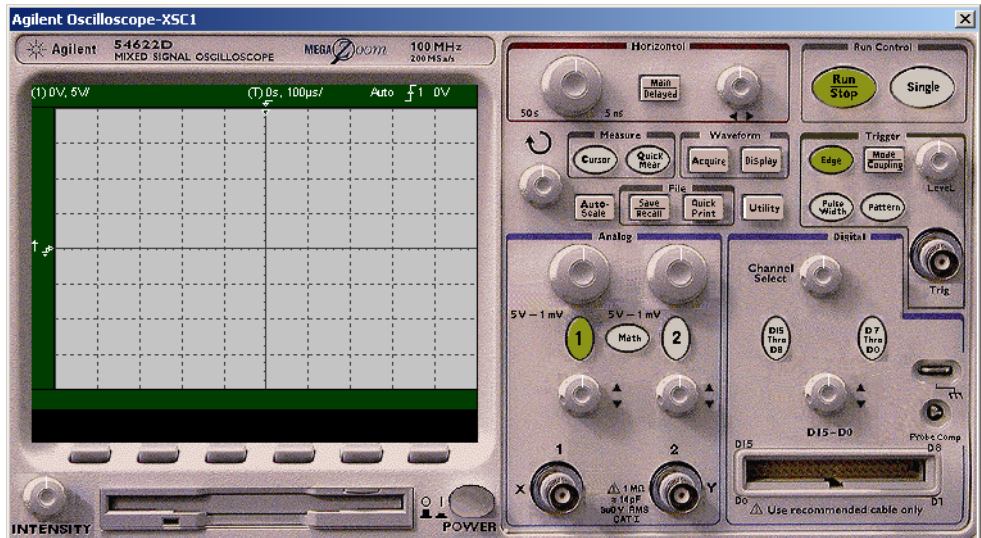

### 10.19.3.1 Supported Features

Most of the features that are documented in the Agilent 54622D User's Guide are available on its simulated version. These include:

Running Mode:	Auto, Single, Stop
Trigger Mode:	Auto, normal, auto-level
Trigger Type:	Edge trigger, pulse trigger, pattern trigger
Trigger Source:	Analog signals, digital signals, external trigger signal
Display Mode:	Main, delay, roll, XY
Signal Channels:	2 analog channels, 1 math channel, 16 digital channels, 1 probe signal for testing purposes
Cursors:	4 cursors

Math Channel:	FFT, multiply, subtract, differentiate, integrate
Measurements:	Cursor information, sampling information, frequency, period, peak-peak, maximum, minimum, rise time, fall time, duty cycle, RMS, width, average, X at max
Display Controls:	Vector/point on traces, trace width, background color, board color, grid color, cursor color
Auto-scale/Undo:	Yes
Print Traces:	Yes
File:	Save data into a DAT format file; can be converted and displayed on the system graph window
Soft-button Menu Operation:	<p>The menu structure is:</p> <p>Main Display MENU</p> <p>1:Main, 2: Delayed, 3:Roll, 4:XY, 5:Vernier, 6:Time Ref</p> <p>Cursor MENU</p> <p>1:Source, 2:X Y, 3:X1, 4:X2, 5:X1 X2, 6:Cursor</p> <p>Quick Measure MENU</p> <p>1:Source, 2:Clear Measure, 3:Frequency, 4:Period, 5:Peak_Peak, 6:Maximum, 7:Minimum, 8:Rise Time, 9:Fall Time, 10:Duty Cycle, 11:RMS, 12:+Width, 13:-Width, 14:Average, 15:X at Maximum</p> <p>Acquire MENU</p> <p>1:Normal, 2:Average, 3:Args</p> <p>Display MENU</p> <p>1:Clear, 2:Grid, 3:Background, 4:Boarder, 5:Vector</p> <p>Auto-Scale MENU</p> <p>1:Undo Auto-scale</p>



Save MENU

1:Save

Quick Print MENU

1:Print

Utility MENU

1:Sampling Information, 2:Default Settings

Edge MENU

1:Source, 2:Shape

Pulse MENU

1:Source, 2:Shape, 3:Operation, 4:Less Value,  
5:Great Value

Pattern MENU

1:Source, 2:L, 3:H, 4:X, 5:Up Edge, 6:Down  
Edge

Mode Coupling MENU

1:Mode, 2:Hold-off Value

Analog Channel MENU

1:Coupling, 2:Vernier, 3:Invert

Math Channel MENU

1:Setting, 2:FFT, 3:Multiply, 4:Subtract,  
5:Differentiate, 6:Integrate

Math FFT MENU

1:Source, 2:Span, 3:Center, 4:Scale, 5:Offset

Math  $1*2/1-2$  MENU

1:Scale, 2:Offset

Math Diff/Inte MENU

1:Source, 2:Scale, 3:Offset

### Digital Channel MENU

1:Select Channel/Enable/Disable, 2:Shape,  
3:Threshold, 4:User Value

## 10.19.3.2 Features Not Supported

The following features are not supported in the simulated version of the oscilloscope included in Multisim.

Remote mode

Terminals on rear panel

Self-test

Hardware error detect

Calibration

Language selection

Infinite Persistence Operation mode

Label button for editing on digital  
channel's label

Delay and phase measurement

Overshoot and preshoot  
measurement

Clock setting

Cursor has normal mode only

Peak detection and real time data  
acquisition

Noise reject and high frequency  
reject modes in data coupling

Duration trigger, IC trigger,  
Sequence trigger

Bandwidth limit feature

### 10.19.3.3 Using the Agilent Oscilloscope

- To connect the simulated Agilent 54622D Oscilloscope to a circuit:
  1. Click on the **Agilent Oscilloscope** tool button, place its icon on the workspace and double-click on the icon to open the instrument. Click on the Power button to switch on the instrument
  2. Wire the icon to the circuit following the pin key below.

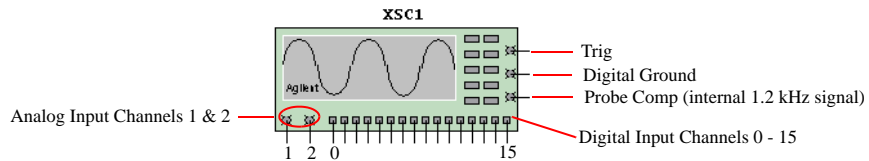

3. Refer to the PDF copy of the instrument's user guide for complete instructions on the use of this device.

**Tip** For optimum simulation speed, set the time scale on the scope near to the value you would like to display during simulation.

**Note** A link to the PDF version of this instrument's user guide can be found at [www.electronicworkbench.com](http://www.electronicworkbench.com).

## 10.20 Tektronix Simulated Oscilloscope



The simulated Tektronix TDS 2024 is a 4-channel, 200-MHz oscilloscope. A link to the PDF version of this instrument's user guide can be found at [www.electronicsworkbench.com](http://www.electronicsworkbench.com).

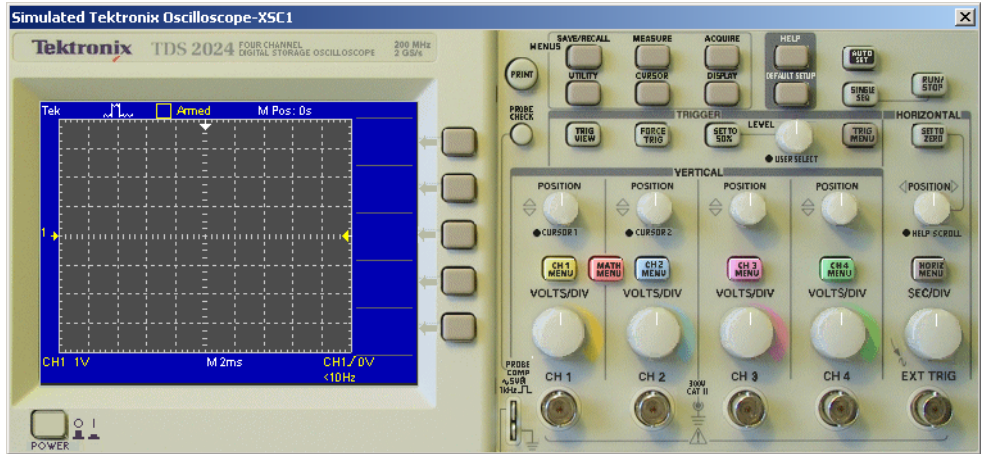

### 10.20.1 Supported Features

Most of the features that are documented in the Tektronix TDS 2024's User Guide are available in its simulated version. These include:

Running Mode:	Auto; Single; Stop.
Trigger Mode:	Auto; Normal.
Trigger Type:	Edge Trigger; Pulse Trigger.
Trigger Source:	Analog signals; Extent trigger signal.
Display Mode:	Main; Window; XY, FFT, Trig View.
Signal Channels:	4 analog channels; 1 math channel; one probe signal in 1kHz for testing purposes.
Cursors:	4 cursors.
Math channel:	FFT; +; -.
Measurements:	Cursor information; Frequency; Period; Peak-Peak; Maximum; Minimum; Rise time; Fall time; RMS; Mean.
Display controls:	Vector/Point on traces; Contrast color control.

Auto-setup: Yes.  
 Print traces: Yes.

### **Control Buttons Operation:**

Run/Stop BUTTON: Start or Stop sampling in multiple-triggers.  
 Single Seq. BUTTON: Start sampling in one-trigger.  
 Trig View BUTTON: See current trigger signal wave and trigger level.  
 Force Trig BUTTON: Immediately to start a trigger.  
 Set to 50% BUTTON: Move trigger level to the mean value of the trigger signal.  
 Set to Zero BUTTON: Set time offset position to zero.  
 Help BUTTON: Goes to instrument help topic.  
 Print BUTTON: Print the graph to printer.  
 Soft Menu BUTTONS: To support the menu controls.

### **Soft Button Menu Operation:**

The soft button menu is a subset of the Tektronix Oscilloscope TDS 2024's:

Save/Recall MENU: 1: Setup; 2: Save; 3: Recall.  
 Measure MENU: Five measure areas, each one includes second a level menu to set a source channel and measure type under: Frequency, Period, Peak\_peak, Maximum, Minimum, Rise time, Fall time; RMS, Mean.  
 Acquire MENU: 1: Sample, 2: Average, 3: Average value.  
 Auto Set MENU: Shows one of three menu lists based on the signal curve type:  
 A) (SIN Curve) 1: Multiple; 2: Single; 3: FFT; 4: Undo, (Pulse curve) 1: Multiple; 2: Single; 3: Slope Up; 4: Slope Down; 5: Undo, (Unknow curve) 1: Mean Value; 2: Peak-Peak Value.  
 Utility MENU: 1: System status, it includes second level menu: 1: Horizontal status; 2: Vertical CH1-CH2 status; 3: Vertical CH3-CH4 status; 4: Trigger status; 5: Misc. status.  
 Cursor MENU: 1: Type; 2: Source.  
 Display MENU: 1: Type, 2: Format, 3: Contrast Increase, 4: Contrast Decrease.  
 Default Setup MENU: 1: Undo Default Setup.  
 Trig MENU: It will show one of three menu lists: A) (Edge Trigger) 1: Type; 2: Source; 3: Slope; 4: Mode; 5: Coupling; B) (Pulse Trigger page 1)

	1: Type; 2: Source; 3: When; 4: Pulse Width; 5: More Page; C) (Pulse Trigger page 2) 1: Type; 2: Polarity; 3: Mode; 4: Coupling; 5) More Page.
Channel MENU:	1: Coupling, 2: Volts/Div, 3: Invert.
Math channel MENU:	It will show one of three sub menu lists: A) (+) 1: Operation; 2: CH1+CH2; 3: CH3+CH4; B) (-) 1: Operation; 2: CH1-CH2; 2: CH2-CH1; 3: CH3-CH4; 4: CH4-CH3; C) (FFT) 1: Operation; 2: Source; 3: Window.
Horizontal MENU:	1: Main; 2: Window Zone; 3: Window; 4: Trig Knob selection.

## 10.20.2 Features Not Supported

The following features are not supported in the simulated version of the oscilloscope:

- Remote mode (without external device and RS 232 interface)
- Terminals on rear panel
- Probe check
- Scan mode display
- Language selection, Error Log and Do Self Calibration on menu item UTILITY
- Saving Wave form, Ref A – Ref D on menu item SAVE/RECALL
- Video Trigger on menu item TRIG MENU
- Trigger coupling of Noise Reject, HF Reject and LF Reject on menu item TRIG MENU
- Cursor source of Ref A --- Ref D on menu item CURSOR
- Persistence display mode on menu item DISPLAY
- Peak detect acquire on menu item ACQUIRE
- FFT Zoom on menu item MATH
- BW limit and Probe selection on menu item CHANNEL.

## 10.20.3 Using the Tektronix Oscilloscope

- To connect the simulated Tektronix TDS 2024 Oscilloscope to a circuit:
  1. Click on the **Tektronix Oscilloscope** tool button, place its icon on the workspace and double-click on the icon to open the instrument. Click on the Power button to switch on the instrument

2. Wire the icon to the circuit following the pin key below.

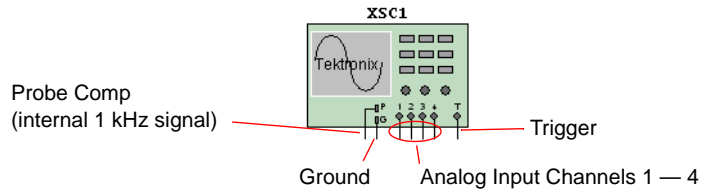

3. Refer to the PDF copy of the instrument’s user guide for complete instructions on the use of this device.

**Note** A link to the PDF version of this instrument’s user guide can be found at [www.electronicworkbench.com](http://www.electronicworkbench.com).

## 10.21 Voltmeter

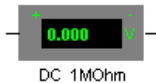

The voltmeter offers advantages over the multimeter for measuring voltage in a circuit. It takes up less space in a circuit and you can rotate its terminals to suit your layout.

### 10.21.1 Using the Voltmeter

#### 10.21.1.1 Resistance (1.0 Ω - 999.99 TΩ)

The voltmeter is preset to a very high resistance (1 MΩ(+)) which generally has no effect on a circuit. If you are testing a circuit that itself has very high resistance, you may want to increase the voltmeter’s resistance to get a more accurate reading. (However, using a voltmeter with very high resistance in a low-resistance circuit may result in a mathematical round-off error.)

- To change the resistance of the voltmeter, double-click on it and change the value in the **Resistance** field that is found in the **Value** tab of the property dialog that displays.

### 10.21.1.2 Mode (DC or AC)

The voltmeter can measure DC or AC voltage. In DC mode, any AC component of the signal is eliminated so that only the DC component of the signal is measured. In AC mode, any DC component is eliminated so that only the AC component is measured. When set to AC, the voltmeter displays the root-mean-square (RMS) value of the signal.

- To change the voltmeter's mode, double-click on it and select either DC or AC in the **Mode** field that is found in the **Value** tab of the property dialog that displays.

### 10.21.1.3 Connecting a Voltmeter

Connect the voltmeter in parallel with the load, attaching the probes to connectors on either side of the load you want to measure. When a circuit is activated and its behavior is simulated, the voltmeter displays the voltage across the test points. (The voltmeter may also display interim voltages before the final steady-state voltage is reached.)

**Note** The voltmeter is found in the **Indicator** component group. It is not found on the **Component** toolbar.

**Note** If a voltmeter is moved after the circuit has been simulated, activate the circuit again to get a reading.

## 10.22 Ammeter

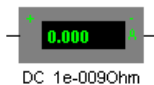

The ammeter offers advantages over the multimeter for measuring current in a circuit. It takes up less space in a circuit and you can rotate its terminals to suit your layout.

### 10.22.1 Using the Ammeter

#### 10.22.1.1 Resistance (1.0 pΩ - 999.99 Ω)

The ammeter's resistance is preset to 1 mΩ, which presents little resistance to a circuit. If you are testing a circuit that has low resistance, you can lower the ammeter's resistance even



further to get a more precise measurement. (However, using an ammeter with very low resistance in a high-resistance circuit may result in a mathematical round-off error.)

- To change the resistance of the ammeter, double-click on it and change the value in the **Resistance** field that is found in the **Value** tab of the property dialog that displays.

### 10.22.1.2 Mode (DC or AC)

The ammeter is preset to DC mode, which measures only the DC component of a signal. If you want to measure the current from an AC source, change the mode to AC. When set to AC, the ammeter displays the root-mean-square (RMS) value of the alternating signal.

- To change the ammeter's mode, double-click on it and select either DC or AC in the **Mode** field that is found in the **Value** tab of the property dialog that displays.

### 10.22.1.3 Connecting an Ammeter

Like a real ammeter, the simulated ammeter must be connected in series at nodes you want to measure. The negative terminal is on the side with the heavy border. If an ammeter is moved after the circuit has been simulated, activate the circuit again to get a reading.

**Note** The voltmeter is found in the **Indicator** component group. It is not found on the **Component** toolbar.

## 10.23 LabVIEW Instruments

You can create your own custom instruments using the LabVIEW graphical development environment. Instruments that you create using LabVIEW can take advantage of the full functionality of the LabVIEW development system, including data acquisition, instrument control, mathematical analysis, and so on. For example, you can create the following kinds of instruments:

- An instrument that acquires data from the real world using a National Instruments data acquisition device or modular instrument. Multisim will then use that data as a signal source for circuit simulation.
- An instrument that displays simulation data simultaneously with multiple measurements (running average and power spectrum, for example) made from that simulation data.

LabVIEW instruments can be either input instruments or output instruments. Input instruments receive simulation data for display or processing. Output instruments generate data to use as a signal source in simulation. A LabVIEW instrument cannot be both an input and output instrument.

Additionally, input and output instruments behave differently. Input instruments continuously receive simulation data from Multisim while simulation is active.

In contrast, at the beginning of circuit simulation, output instruments will first generate a finite amount of data and return that data to Multisim. Multisim will then use that data for circuit simulation. Output instruments do not continuously generate data while simulation is running. To cause an output instrument to generate new data, you must stop and restart simulation.

Output instruments allow the user or creator of the instrument to determine whether the instrument repeats the output data. If you configure the instrument and not repeat the output data and simulate a circuit which uses the instrument, once the simulation time has exceeded the length of the generated data, Multisim will continue to simulate but the output signal from the instrument will fall to 0 volts. Alternatively, if you configure the instrument and repeat the output data, the instrument will repeatedly output the initially generated data until you stop simulation.

Input instruments allow the user or creator of the instrument to set a sampling rate. This sampling rate is the rate at which the instrument receives data from Multisim. This sampling rate is analogous to the sampling rate you would set for a physical data acquisition device or modular instrument that acquires data from the real world. You should observe the Nyquist sampling theorem when choosing a sampling rate for your instrument. Note that the higher the value of the sampling rate, the slower simulation will run.

### 10.23.1 System Requirements

To create and modify LabVIEW instruments, you must have the LabVIEW 8.0 (or later) Development System.

To use LabVIEW instruments, you must have the LabVIEW Run-Time Engine installed on your computer. The version of this Run-Time Engine must correspond to the version of the LabVIEW Development System used to create the instrument. The Multisim installer includes the LabVIEW Run-Time Engine 8.0 as part of the Electronics Workbench Shared Components installation.

### 10.23.2 Sample LabVIEW Instruments

Multisim includes the following sample LabVIEW instruments:

- **Microphone** — Records audio from the computer sound device and outputs the sound data as a signal source.
- **Speaker** — Plays input signal using the computer sound device.
- **Signal Generator** — Generates and outputs a sine, triangle, square, or sawtooth wave.
- **Signal Analyzer** — Displays time-domain data, auto power spectrum, or running average of input signal.

The source code for the example instruments is available in the directory where you installed Multisim at `... \samples \LabVIEW Instruments`.

### 10.23.2.1 Microphone

The **Microphone** instrument allows you to record sound data from devices attached to the input of your computer's sound device (e.g., microphone, CD player). It then outputs that data as a signal in Multisim. You configure the settings and record the sound before beginning simulation. Multisim will then use the audio signal as a signal source during simulation.

- To use the **Microphone**:
  1. Place it in a schematic and open its face.
  2. Select the desired audio **Device** (usually the default device is correct), the **Recording Duration**, and the desired **Sample Rate**. The higher the value you choose for the **Sample Rate**, the higher the quality of the output signal, but the slower simulation using that data will run.
  3. Click **Record Sound** to record the signal that is connected to the input connection of your computer's sound device.
  4. Before starting simulation, you can also choose to **Repeat Recorded Sound**. If you do not enable this option and simulate the circuit, once the simulation time has exceeded the length of the recorded signal, Multisim will continue to simulate but the output signal from the **Microphone** instrument will fall to 0 volts. If you enable this option, the **Microphone** instrument will repeatedly output the recorded data until you stop simulation.
  5. Begin simulation of the circuit. The **Microphone** instrument will output the recorded sound as a voltage signal.

### 10.23.2.2 Speaker

The **Speaker** instrument allows you to output a voltage signal as sound using your computer's sound device. You configure the settings before beginning simulation and play the sound after stopping simulation.

- To use the **Speaker**:
  1. Place the instrument in a schematic and open its face.
  2. Select the desired audio **Device** (usually the default device is correct), the **Playback Duration**, and the **Sample Rate** at which the instrument should receive data from the simulation.

If you are using the **Speaker** instrument in conjunction with the **Microphone** instrument, set the **Sample Rate** of the two instruments to be the same. Otherwise, set the sample rate of the Speaker to be at least twice the frequency of the input signal. Note that the higher the value of the sample rate, the slower simulation will run.

3. Begin simulation of the circuit. As simulation runs, the **Speaker** instrument collects the input data until the simulation time reaches the limit you configured in the **Playback Duration** field.
4. Stop simulation and click **Play Sound** to play as sound the data that the **Speaker** stored during the simulation.

### 10.23.2.3 Signal Generator

The **Signal Generator** instrument is an example of how to implement a simple LabVIEW instrument that generates or acquires data and then outputs it as a signal source for simulation.

- To use the **Signal Generator**:
  1. Place the instrument in a schematic and open its face.
  2. Set the desired **Signal Information** parameters and **Sampling Info**. If desired, enable **Repeat Data**.
  3. Begin simulation. The instrument generates the output data and then outputs that data as a signal source for the simulation.

### 10.23.2.4 Signal Analyzer

The **Signal Analyzer** instrument is an example of how to implement a simple LabVIEW instrument that receives, analyzes, and displays simulation data.

- To use the **Signal Analyzer**:
  1. Place the instrument in a schematic and open its face.
  2. Set the desired **Analysis Type** and **Sampling Rate** (rate at which the instrument receives data from the simulation). The sampling rate of the **Signal Analyzer** should be at least twice the frequency of the input signal.
  3. Begin simulation.

## 10.23.3 Creating a LabVIEW Instrument

**Note** This section assumes existing familiarity with LabVIEW and concepts such as VIs, VI Libraries, Projects, and Build Specifications. Refer to the LabVIEW documentation for more information on these topics.

The primary component of a LabVIEW instrument for Multisim is a VI template (.vit file) that serves as the face of the instrument and handles communication with Multisim.

Multisim includes templates for creating both input and output instruments. These starter templates include a LabVIEW Project with the necessary settings for building the final

instrument and a VI template that contains the front panel and block diagram objects necessary for the VI to communicate with Multisim.

These starter templates are available in the directory where you installed Multisim at:

- `... \samples \LabVIEW Instruments \Templates \Input` – Use these files when creating a new instrument that receives simulation data from Multisim.
- `... \samples \LabVIEW Instruments \Templates \Output` – Use these files when creating a new instrument that generates data to use as a signal source in Multisim.

The starter Projects, `StarterInputInstrument.lvproj` and `StarterOutputInstrument.lvproj`, each contain a Source Distribution Build Specification. The output of each Build Specification will go to `... \samples \LabVIEW Instruments \Templates \Input \Build` and `... \samples \LabVIEW Instruments \Templates \Output \Build`. This output is what you must install into Multisim to use the instrument. Refer to “10.23.4 Building a LabVIEW Instrument” on page 10-92 and “10.23.5 Installing a LabVIEW Instrument” on page 10-93 for more information on building and installing a LabVIEW instrument.

➤ To create your own Multisim instrument:

1. Copy the contents of the `... \samples \LabVIEW Instruments \Templates \Input` (or `... \samples \LabVIEW Instruments \Templates \Output`) directory to an empty directory on your computer.
2. Open the copy of `StarterInputInstrument.lvproj` (or `StarterOutputInstrument.lvproj`) in LabVIEW.
3. In the Project tree, right click on the `My Computer>>Instrument Template>>StarterInputInstrument.vit` (or `StarterOutputInstrument.vit`) item and select **Open**.
4. In the window for the VI template, select `File>>Save As`. In the save dialog that appears, select the **Rename** option and click **Continue**. In the next dialog, choose a new name (and location, if you desire) for the VI template and click **OK**.
5. Close the newly renamed VI template.
6. In the Project tree, right click on the `My Computer>>subVIs>>StarterInstrument_multisimInformation.vi` (or `StarterOutputInstrument_multisimInformation.vi`) item and select **Open**.
7. In the window for the VI, select `File>>Save As`. In the save dialog that appears, select the **Rename** option and click **Continue**. In the next dialog, choose a new name (and location, if you desire) for the VI and click **OK**. The new name for the VI should be <Name chosen in step 4, minus the .vit extension>\_multisimInformation.vi. For example, if you renamed the VI template in step 4 `My Instrument.vit`, the name for this VI should be `My Instrument_multisimInformation.vi`.

8. Close the newly renamed VI.
9. Right click on the My Computer>>Build Specification>>Source Distribution item in the Project tree and select **Properties** from the context menu to edit the Build Specification.
10. In the Custom Destinations section of the Destination Settings page of the Build Specification Properties dialog, modify the final VI library in the Destination Path for the Destination Directory to something unique (for example, My Custom Instrument.llb).
11. In the same location, modify the final directory in the Destination Directory for the Support Directory to something unique (for example, My Custom Instrument).
12. Click **OK** on the Build Specification Properties dialog and save the Project file.
13. Open the template VI.
14. Edit the icon of the template VI. Multisim will use this icon in the center of the symbol for the instrument.
15. Follow the guidelines and instruments listed in the comment fields on the block diagram of the template VI to create your custom instrument. The example LabVIEW instruments provide excellent guides for how to modify the starter instruments to add custom functionality.
16. Save the VI template.

## 10.23.4 Building a LabVIEW Instrument

- To ready a LabVIEW instrument for installation into Multisim, build the Source Distribution Build Specification in the LabVIEW Project for your instrument.
- To build the Build Specification for your instrument, right click on the My Computer>>Build Specification>>Source Distribution item in the Project tree for the instrument and select **Build** from the context menu.

The output of this build process is as follows:

- VI library file (.llb) containing the main VI template, any VIs used in the hierarchy of the main VI template, and all VIs that are members of Libraries referenced in the main VI template hierarchy, regardless of whether they are actually used in the hierarchy of the instrument.
- A directory with the same name as the VI library (minus the .llb extension) that contains any non-VI portions of the template hierarchy and referenced Projects. These files can be DLLs, LabVIEW menu files, and so on.

## 10.23.5 Installing a LabVIEW Instrument

- To install a LabVIEW instrument into Multisim, copy the output of the build process (a uniquely named VI library and directory) into the `... \lv instruments` directory where you installed Multisim. The next time you launch Multisim, the instrument will appear under the **LabVIEW Instruments** button in the **Instruments** toolbar.

## 10.23.6 Guidelines for Successfully Creating a LabVIEW Instrument

When creating a LabVIEW instrument for Multisim, you must follow certain guidelines:

- Always create new instruments from either the template instrument files or one of the example instruments. These files include the front panel objects, block diagram objects, and settings necessary for the instrument to behave correctly.
- Do not delete or modify the existing diagram objects in the starter template VI. You may add additional controls/indicators and handle additional events in the main event loop, but do not modify or delete any of the existing event-handling code.
- You may add diagram code to the starter template VI where specified in the comments on the block diagram.
- Every LabVIEW instrument installed in Multisim must have a unique name. Specifically, the VI library that contains the main VI template, the support files directory, and the main VI template itself must all have unique names.
- All subVIs used in a LabVIEW instrument must have unique names unless you intend to use the same subVI across multiple instruments.
- All Libraries used in a LabVIEW instrument must have unique names unless you intend to use the same Libraries across multiple instruments.
- All LabVIEW instruments that contain VIs that are part of a Library must be built using the same version of that Library. If you build an instrument using a Library and then make changes to that Library before building another instrument to install on the same computer, you must also rebuild and reinstall the original instrument.
- The Source Distribution Build Specification in the LabVIEW Project for the instrument must be configured to always include all contained items. To make this configuration, navigate to the Source File Settings page of the Source Distribution Build Specification Properties dialog, select Dependencies in the Project Files tree, and enable the **Set inclusion type for all contained items>>Always include** option. This option is already enabled correctly in the starter instrument LabVIEW Projects.
- Consider whether subVIs you create for your instruments should be marked as Reentrant. If subVIs use instance-specific constructs such as uninitialized shift registers, the First Call? function, and so on, you will need to mark the VI for **Reentrant execution** under

File>>VI Properties>>Execution. This setting is necessary to allow multiple instances of the same LabVIEW instrument to behave correctly.



# Chapter 11

## Analyses

This chapter explains how to use the various analyses included in Multisim 9. It explains how to work with analyses in general, the specific settings and options for each individual analysis, and how to view and manipulate analyses results.



Some of the features described in this chapter may not be available in your edition of Multisim 9. Such features have an icon in the column next to their description. Refer to the release notes for a list of the features in your edition.

The following analyses are described in this chapter.

<b>Subject</b>	<b>Page No.</b>
<b>Introduction to Multisim Analyses</b>	11-4
<b>Viewing the Analysis Results: Grapher</b>	11-4
Working with Pages on the Grapher	11-7
Working with Graphs	11-8
Viewing Charts	11-19
Cut, Copy and Paste	11-20
Opening and Saving Files	11-21
Print and Print Preview	11-22
<b>Working with Analyses</b>	11-23
General Instructions	11-23
The Analysis Parameters Tab	11-24
The Output Tab	11-24
Adding Analysis Expressions	11-27
The Analysis Options Tab	11-29
The Summary Tab	11-30
Incomplete Analyses	11-30
<b>DC Operating Point Analysis</b>	11-31
About the DC Operating Point Analysis	11-31
Setting up and Running DC Operating Point Analysis	11-31
Sample Circuit	11-32
Troubleshooting DC Operating Point Analysis Failures	11-33

Subject	Page No.
<b>AC Analysis</b>	11-35
About the AC Analysis	11-35
Setting AC Analysis Frequency Parameters	11-36
<b>Transient Analysis</b>	11-38
About the Transient Analysis	11-38
Setting Transient Analysis Parameters	11-38
Troubleshooting Transient Analysis Failures	11-40
<b>Fourier Analysis</b>	11-41
About the Fourier Analysis	11-41
Setting Fourier Analysis Parameters	11-42
<b>Noise Analysis</b>	11-44
About the Noise Analysis	11-44
Setting Noise Analysis Parameters	11-46
Noise Analysis Example	11-49
<b>Distortion Analysis</b>	11-51
Multisim Approach	11-52
Preparing the Circuit for Distortion Analysis	11-52
Understanding the Distortion Analysis Options	11-53
Distortion Analysis for Harmonic Distortion	11-54
Distortion Analysis for Intermodulation Distortion	11-56
<b>DC Sweep Analysis</b>	11-59
Setting DC Sweep Analysis Parameters	11-59
DC Sweep Analysis Examples	11-60
<b>DC and AC Sensitivity Analyses</b>	11-65
Sensitivity Analysis Parameters	11-65
Setting Up and Running Sensitivity Analysis	11-66
<b>Parameter Sweep Analysis</b>	11-71
About the Parameter Sweep Analysis	11-71
Setting Parameter Sweep Analysis Parameters	11-72
Parameter Sweep Analysis – Example	11-74
<b>Temperature Sweep Analysis</b>	11-80
About the Temperature Sweep Analysis	11-80
Setting Temperature Sweep Analysis Parameters	11-81
<b>Transfer Function Analysis</b>	11-83
About the Transfer Function Analysis	11-83
Setting Transfer Function Analysis Parameters	11-84
Examples of Transfer Function Analysis	11-85

<b>Subject</b>	<b>Page No.</b>
<b>Worst Case Analysis</b>	11-89
About the Worst Case Analysis	11-89
Setting Worst Case Analysis Parameters	11-92
Worst Case Analysis Example	11-93
<b>Pole Zero Analysis</b>	11-96
About the Pole Zero Analysis	11-96
Setting Pole Zero Analysis Parameters	11-99
Running Pole Zero Analysis	11-101
<b>Monte Carlo Analysis</b>	11-103
About the Monte Carlo Analysis	11-103
Setting Up and Running Monte Carlo Analysis	11-106
Monte Carlo Analysis Example	11-108
<b>Trace Width Analysis</b>	11-115
Multisim Approach	11-116
Sample Trace Width Analysis	11-118
<b>RF Analyses</b>	11-121
<b>Nested Sweep Analyses</b>	11-121
<b>Batched Analyses</b>	11-123
<b>User Defined Analyses</b>	11-124
About the User Defined Analysis	11-124
Creating and Simulating a SPICE Netlist	11-125
Importing the SPICE netlist into Multisim	11-126
Plotting Two Nodes Using the Tran Statement	11-127
How to Run an AC Analysis	11-128
<b>Analysis Options dialog box</b>	11-129
Global tab	11-130
DC tab	11-132
Transient tab	11-133
Device tab	11-134
Advanced tab	11-135

## 11.1 Introduction to Multisim Analyses

Multisim offers you many analyses, all of which utilize simulation to generate the data for the analysis you want to perform. These analyses can range from quite basic to extremely sophisticated, and can often require one analysis to be performed (automatically) as part of another.

For each analysis, you will need to decide upon some settings that will tell Multisim what you want the analysis to do. In addition to the analyses provided by Multisim, you can also create user-defined analyses based on SPICE commands you enter.

When you activate an analysis, the results are displayed on a plot in Multisim's **Grapher** (see "11.2 Viewing the Analysis Results: Grapher" on page 11-4 for more information) (unless you specify otherwise) and saved for use in the **Postprocessor** (not available in all editions of Multisim; see Chapter 12, "Postprocessor" for more information). Some results are also written to an audit trail, which you can view. See "9.7 Simulation Error Log/Audit Trail" on page 9-25 for more information.

To indicate that an analysis is running, the **Simulation Running Indicator** appears in the status bar as in the example below. This indicator flashes until the analysis is complete.



**Note** Some analyses are performed so quickly, that you will not notice the **Simulation Running Indicator** flashing.

## 11.2 Viewing the Analysis Results: Grapher

- To have the **Grapher** appear, select **View/Grapher**.



The **Grapher** is a multi-purpose display tool that lets you view, adjust, save, and export graphs and charts. It is used to display:

- the results of all Multisim analyses in graphs and charts
- a graph of traces for some instruments (for example the results of the postprocessor, oscilloscope and Bode Plot).

The display shows both graphs and charts. In a graph, data are displayed as one or more traces along vertical and horizontal axes. In a chart, text data are displayed in rows and columns. The window is made up of several tabbed pages, depending on how many analyses, etc. have been run.

Each page has two possible active areas which will be indicated by a red arrow: the entire page indicated with the arrow in the left margin near the page name of the chart/graph indicated with the arrow in the left margin near the active chart/graph. Some functions, such

as cut/copy/paste, affect only the active area, so be sure you have selected the desired area before performing a function.

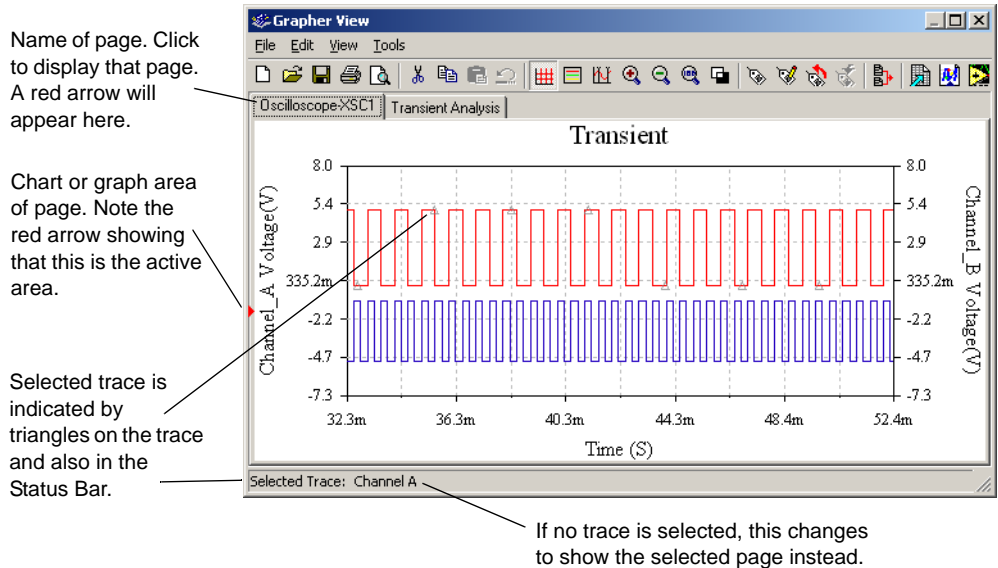

Some analyses, such as the **AC Analysis**, create both a phase and magnitude graph on the same page when the analysis is run. In this case, the x-axes (frequency) of the plots will line up as

shown below. This is the default setting only; you can change the setting for individual graphs as shown in “11.2.2.6 Axes” on page 11-15.

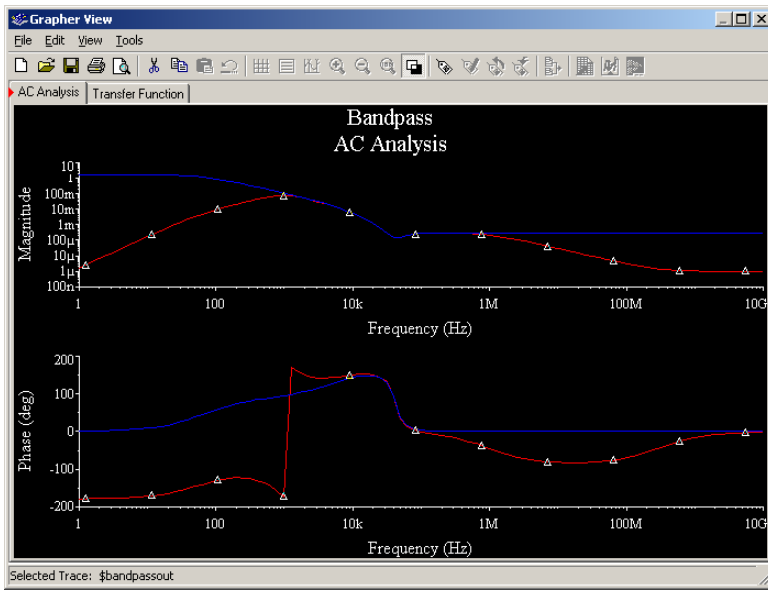

The window offers a number of buttons on a toolbar:

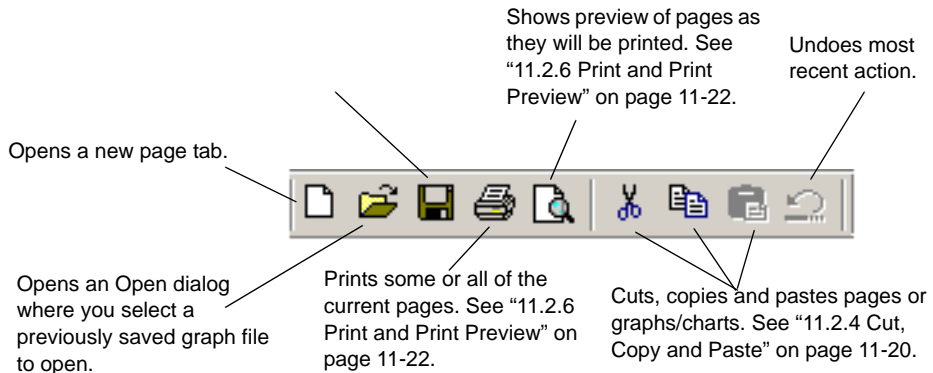

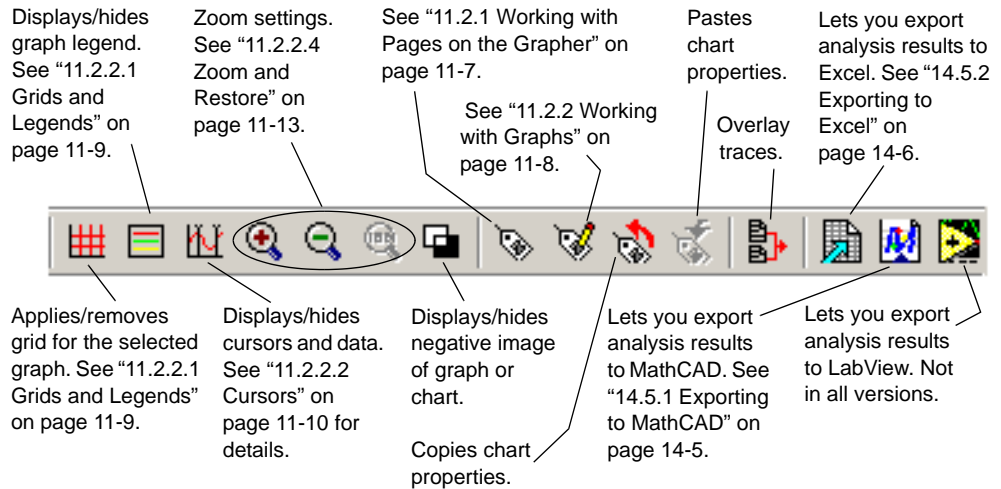

## 11.2.1 Working with Pages on the Grapher

Every analysis you perform on a circuit displays its results on a separate page of the **Grapher**. Every trace may also appear on a separate page, if that is how you have set up your analysis.

- To view a page on the **Grapher**, click its tab.
- To scroll through pages (when there are too many tabs to fit in the available space), click the forward or reverse arrow buttons that appear at the right edge of the tabs.
- To change page properties:
  1. Select a page by clicking its tab.

2. Click the **Page Properties** button. The **Page Properties** dialog box appears.

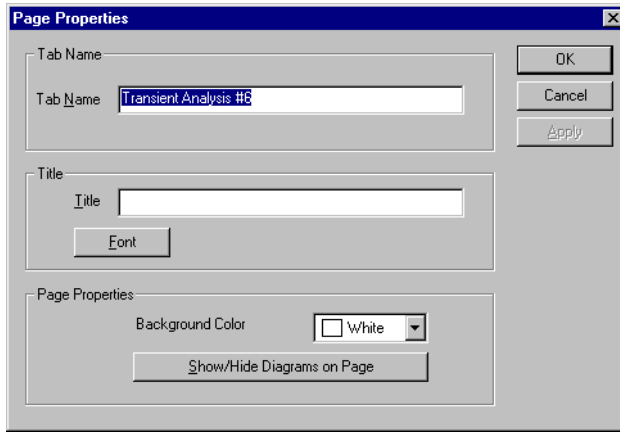

To change:	Do this:
Name of the tab	modify <b>Tab Name</b> field
Title of chart or graph	modify <b>Title</b> field
Title's font	click <b>Font</b> button and choose from fonts displayed
Background color of page	select from <b>Background Color</b> drop-down list box
Which diagrams appear on the page	click <b>Show/Hide Diagrams on Page</b> and select from the list that appears.

3. To apply the change and close the dialog box, click **OK**. To apply the change and leave the dialog box open for additional selections, click **Apply**.

## 11.2.2 Working with Graphs

To help you examine graphical data, you can use a grid, a legend and vertical cursors. You can also zoom in on any part of a graph. You can apply these tools separately or together. In addition, you can change several graph display characteristics from the tabs of the **Graph Properties** dialog box.

**Note** To display the **Graph Properties** dialog box or to use the buttons described in this section, you must have a graph selected. Click on a graph to select it. A red arrow



appears to the left of the graph to indicate it is selected. Your selection is also indicated in the **Status Bar** at the bottom of the **Grapher**.

### 11.2.2.1 Grids and Legends

➤ To apply a grid to a graph:

1. Select a graph by clicking anywhere on it.
2. Click the **Show/Hide Grid** button. To remove the grid, click the button again.



*Or*

Select a graph by clicking anywhere on it.



1. Click the **Properties** button. The **Graph Properties** dialog box appears:

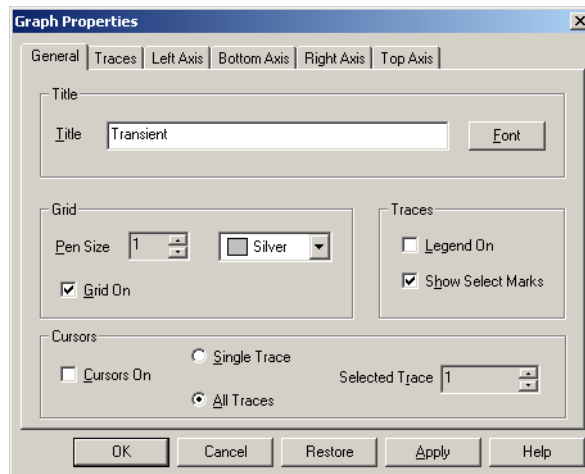

2. Click the **General** tab.
3. Enable the **Grid On** option. If desired, change the grid pen size and color.

➤ To apply a legend to a graph:

1. Select a graph by clicking anywhere on it.
2. Click the **Show/Hide Legend** button. To remove the legend, click the button again.



*Or*

1. Select a graph by clicking anywhere on it.
2. Click the **Properties** button. The **Graph Properties** dialog box appears.
3. Select the **General** tab.
4. Enable the **Legend On** option. If desired, change the labels of the traces using the **Traces** tab. See “11.2.2.7 Traces” on page 11-16 for details.

## 11.2.2.2 Cursors

When you activate the cursors feature, two vertical cursors appear on the selected graph. At the same time, a window pops up, displaying a list of data for one or all traces.

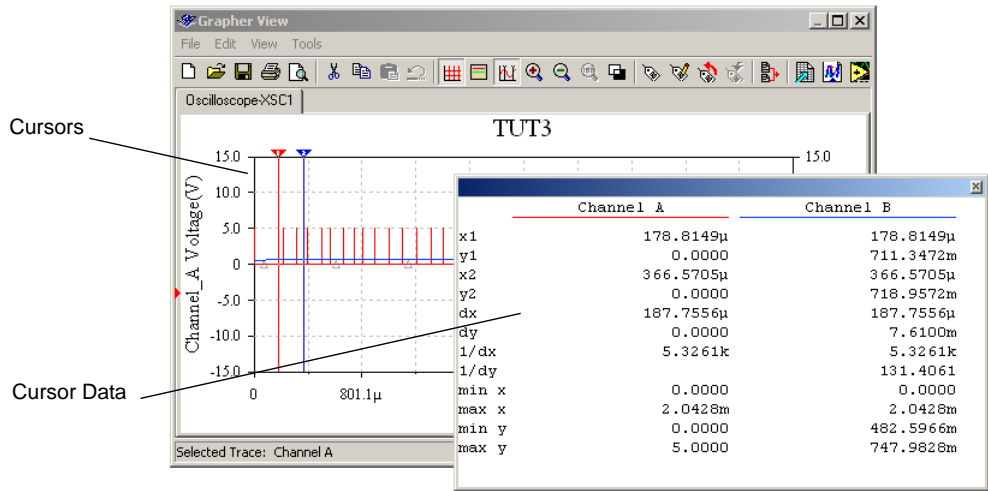

The cursor data include:

x1,y1	(x,y) co-ordinates for the left cursor
x2,y2	(x,y) co-ordinates for the right cursor
dx	x-axis delta between the two cursors
dy	y-axis delta between the two cursors
1/dx	reciprocal of the x-axis delta
1/dy	reciprocal of the y-axis delta
min x, min y	x and y minima within the graph ranges
max x, max y	x and y maxima within the graph ranges

➤ To activate the cursors:

1. Select a graph by clicking anywhere on it.
2. Click the **Show/Hide Cursors** button. To hide the cursors, click the button again.



*Or*

1. Select a graph by clicking anywhere on it.



2. Click the **Properties** button. The **Graph Properties** dialog box appears.
  3. Select the **General** tab.
  4. Enable the **Cursors On** option.
  5. Select **Single Trace** to view cursor data for one trace or **All Traces** to view cursor data for all traces. If you select **Single Trace** and there is more than one trace in your graph, use the **Trace** field to select the one you want.
- To move a cursor, click and drag it horizontally.

### 11.2.2.3 Cursor Pop-up Menu

- To move a cursor to a precise location:
1. Right-click on the cursor you wish to move. The following pop-up displays.

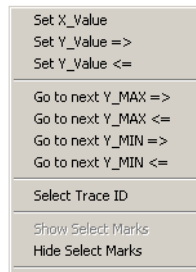

2. Choose **Select Trace ID**. The following dialog box appears.



3. Select the trace which you wish to use as the reference for the other options in the pop-up menu from the **Trace** drop-down list. When you select any of the other options in the pop-up, the cursor will move to the specific location on the trace that you select in this step.
4. Right-click on the cursor you wish to move and choose one of the following options:
  - **Set X\_Value** — click to display the following dialog box. Enter the desired location on

the x-axis and click **OK**. The cursor moves to that location.

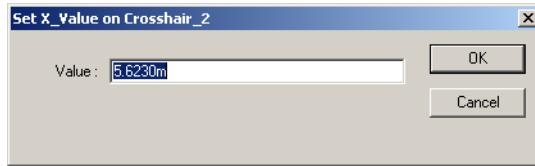

- **Set Y\_Value =>** — click to display the following dialog box. Enter the desired location on the y-axis to where you would like the cursor to move and click **OK**. The cursor moves to the *right*, to the first place when that value occurs.

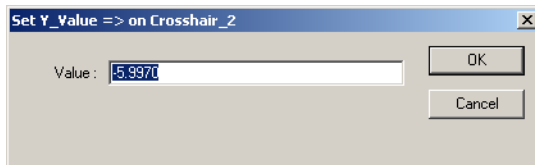

- **Set Y\_Value <=** — click to display the following dialog box. Enter the desired location on the y-axis to where you would like the cursor to move and click **OK**. The cursor moves to the *left*, to the first place when that value occurs.



- **Go to next Y\_MAX =>** — click to move the cursor to the first occurrence of the maximum Y value that is to the *right* of its current location.
- **Go to next Y\_MAX <=** — click to move the cursor to the first occurrence of the maximum Y value that is to the *left* of its current location.
- **Go to next Y\_MIN =>** — click to move the cursor to the first occurrence of the minimum Y value that is to the *right* of its current location.
- **Go to next Y\_MIN <=** — click to move the cursor to the first occurrence of the minimum Y value that is to the *left* of its current location.

## 11.2.2.4 Zoom and Restore

- To zoom in on any part of a graph:
  1. Select a graph by clicking anywhere on it.
  2. Click and drag the pointer until the dotted enlargement box covers the region of the graph that you want to zoom in on. .

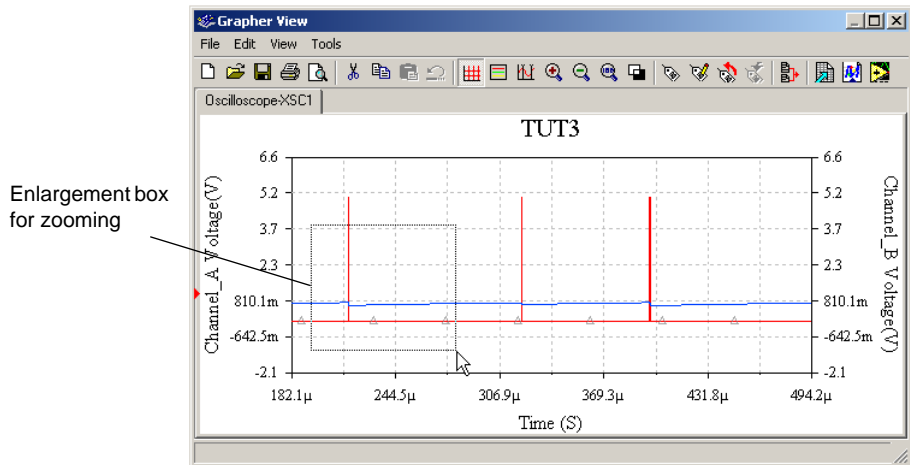

3. Release the mouse button. The axes are scaled and the graph redrawn based on the enlargement box.

*Or*

1. Select a graph by clicking anywhere on it.
2. Click the **Properties** button. The **Graph Properties** dialog box appears.



3. Click an axis tab to zoom along that axis. For example, choose the **Bottom Axis** tab to zoom along the horizontal dimension. (Check the **Traces** tab to see which axis is used for the range you want to zoom.)

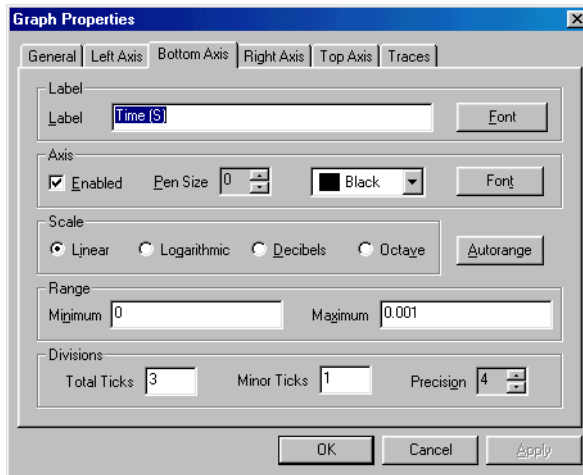

4. Type a new minimum and maximum.



- To restore a graph to its original scale, click the **Zoom Restore** button.

### 11.2.2.5 Title

- To apply a title to a graph:

1. Select a graph by clicking anywhere on it.



2. Click the **Properties** button. The **Graph Properties** dialog box appears.
3. Choose the **General** tab.
4. Type a new title in the **Title** field. To change the title's font, click the **Font** button.

## 11.2.2.6 Axes

You can change several characteristics of a graph's axes from the four axes tabs in the **Graph Properties** dialog box. The options are identical in each of the tabs.

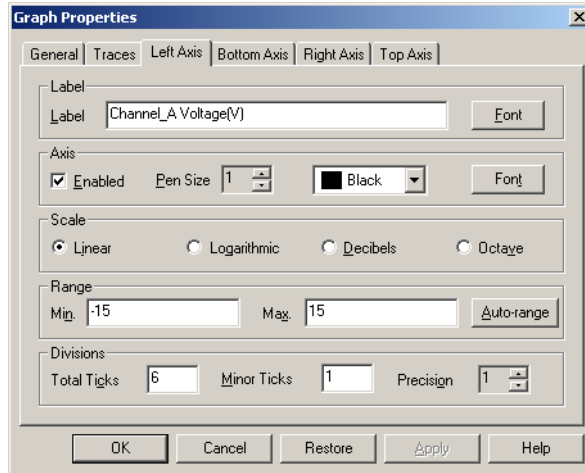

- To change the characteristics of an axis:
  1. Select a graph by clicking anywhere on it.
  2. Click the **Properties** button. The **Graph Properties** dialog box appears.
  3. Click the axis tab for the axis you want to change.



4. Change any of the axis' characteristics, using the following fields:

Field	Use
Label	Label for the axis. To change the axis font, click <b>Font</b> .
Pen Size	Controls the thickness and color of the axis and the font of the axis' values. To change color or font, click <b>Color</b> or <b>Font</b> .
Minimum/ Maximum	Controls the minimum and maximum values displayed. Values change when you zoom.
Number	Sets the number of tick marks on axis.
Frequency	Sets the occurrence of values on tick marks. For example, "2" means that a value appears every two tick marks.
Precision	Sets the number of significant digits for axis values.
Scale	Sets a multiplication factor for axis values. Changes the scale of the axis.
Enabled	Determines whether or not the axis appears.

### 11.2.2.7 Traces

- To select a trace, left-click on it. Trace select marks appear on the selected trace (small triangles along the trace).
- To change other trace properties:
  1. Right-click on the trace to display the following pop-up.

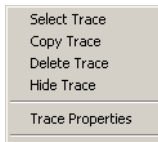

2. Select the desired item from the pop-up.



You can change several characteristics of each trace in a graph from the **Traces** tab in the **Graph Properties** dialog box.

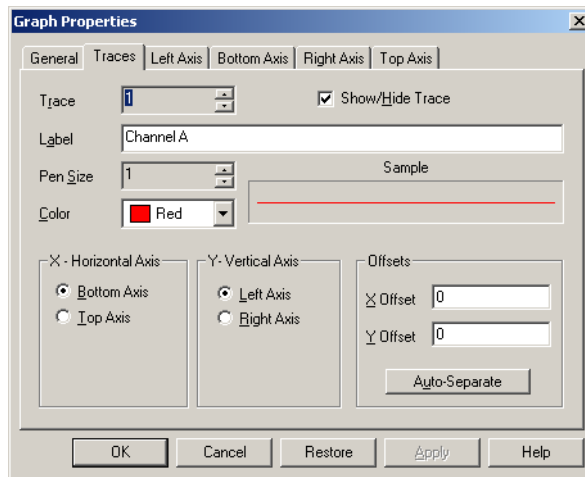

- To change the characteristics of a trace:
1. Select a graph by clicking anywhere on it.
  2. Click the **Properties** button. The **Graph Properties** dialog box appears.
  3. Click the **Traces** tab.
  4. Select a trace.
  5. Change any of the trace's characteristics, using the following fields:



Field	Use
Trace	Specifies the trace whose properties are being affected.
Label	Specifies a label for the trace. Appears in legend.
Pen Size	Controls the thickness of the trace.
Color	Controls the color of the trace. The <b>Sample</b> box shows a preview.
Bottom Axis/Top Axis	Controls the X range of the trace.
Left Axis/Right Axis	Controls the Y range of the trace.
X Offset/Y Offset	Value to offset the trace from its original coordinates.
Auto-Separate Button	Offsets multiple traces in a graph for easier viewing.

### 11.2.2.8 Merging Traces

- To traces together onto a new graph:
  1. Click on the **Overlay Traces** button. The **Select a Graph** dialog box appears.

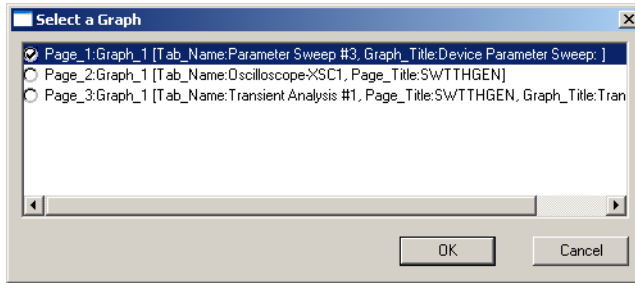

2. Select the files you wish to merge together and click **OK**. A new graph appears with the merged traces.

### 11.2.2.9 Select Pages dialog box

The **Select Pages** dialog box is used to select pages to print, preview or remove from the **Grapher**.

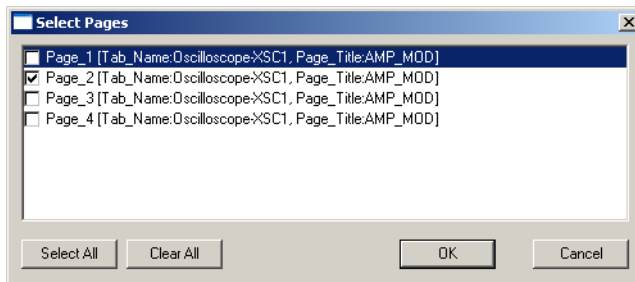

- To preview pages before printing:
  1. Select **File/Print Preview** from the **Grapher**. The **Select Pages** dialog box appears.
  2. Check the pages you wish to preview and click **OK**.
 

**Note** The **Select Pages** dialog does not appear if there is only one page open in the **Grapher**.
- To print pages:
  1. Select **File/Print** from the **Grapher**. The **Select Pages** dialog box appears.
  2. Check the pages you wish to print and click **OK**.
 

**Note** The **Select Pages** dialog does not appear if there is only one page open in the **Grapher**.

- To remove pages from the **Grapher**:
  1. Select **Edit/Clear Pages**. The **Select Pages** dialog box appears.
  2. Check the pages you wish to delete and click **OK**.

**Note** The **Select Pages** dialog does not appear if there is only one page open in the **Grapher**.

### 11.2.2.10 Graph Pop-up Menu

- To view the graph's pop-up menu:
  1. Right-click on the background of a graph.

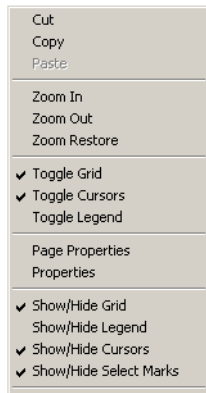

**Note** For the pop-up accessed from a trace, see “11.2.2.7 Traces” on page 11-16.

2. Select the desired option from the pop-up.

## 11.2.3 Viewing Charts

To help you examine and organize a chart, you can sort rows, adjust column widths, change precision and add a title.

- To sort a row of data, click the column name button of the column you want to sort by. Sorting order is from low to high for numbers; otherwise, it is alphabetical.
- To adjust the width of a column, click and drag the left edge of the column name button.
- To change the chart's column precision (number of significant digits) or title:
  1. Select a chart by clicking anywhere on it.

2. Click the **Properties** button. The **Chart Properties** dialog box appears.

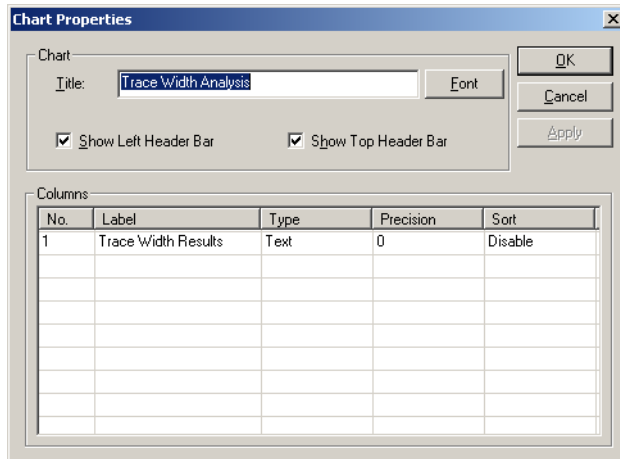

3. To change the chart title, type a new title. To change the font, click the **Font** button.
4. To change a column's precision, select a column number and a precision (number of significant digits). Precision only affects columns that contain numerical values.
5. Click **OK**.

## 11.2.4 Cut, Copy and Paste

The **Grapher** lets you cut, copy and paste pages, graphs and charts.

**Note** You must use the cut, copy and paste buttons from the **Grapher** window. You cannot use the Multisim menus, buttons or keyboard shortcuts for these functions.

- To cut, copy and paste pages:



1. Select a page by clicking on its tab.
2. Click the **Cut** or **Copy** button.



3. Click the **Paste** button. The cut or copied page appears.

**Note** When a page is selected (the red arrow points to the tab), cut, copy and paste affect page properties only. They do *not* affect the graphs or charts on the page.

- To cut, copy and paste graphs and charts:

1. Select a graph or chart.
2. Click the **Cut** or **Copy** button.
3. Click the **Paste** button to paste the graph or chart onto the same page.

or, to paste onto a new page:



4. Click the **New** button.
5. Choose **New Page**.
6. Type a tab name and click **OK**.
7. Click the **Paste** button.

**Note** When a graph or chart is selected (the red arrow points to the graph or chart), cut, copy and paste affect the selected graph or chart only. They do *not* affect overall page properties.

- To open a new page, click the **New** button and choose **New Page**.
- To delete all pages, click the **New** button and choose **Delete All Pages**.

## 11.2.5 Opening and Saving Files

- To open an existing file in the **Grapher**:



1. Click the **Open** button. A file browser appears.
2. Select the desired file type from the drop-down list. Available file types are:
  - Graph files (\*.gra) — Multisim **Grapher** files.
  - Data files (\*.dat) — files created and saved from the Agilent Simulated Oscilloscope.
  - Scope data (\*.scp) — files created and saved from the Multisim oscilloscope.
  - Bode data (\*.bod) — files created and saved from the Multisim bode plotter.
3. Select the file you want to open.
4. Click **Open**.

- To save a file in the **Grapher**:



1. Click the **Save** button. A file browser appears.
2. Select the desired file type from the drop-down list. Available file types are:
  - Graph files (\*.gra) — Multisim **Grapher** files.
  - Text files (\*.txt) — standard text files.
  - Text-based measurement files (\*.lvm) — files such as those created in National Instruments LabVIEW.
  - Binary measurement files (\*.tdm) — files used to exchange data between National Instruments software, such as LabVIEW and DIAdem. Note that when you save data as a DIAdem file, two files are created; a header file (.tdm) and a binary file (.tdx).

3. Select a file you want to overwrite or type a new filename. Graph files have the file extension `.gra`. The file extension is automatically added.
4. Click **Save**.

## 11.2.6 Print and Print Preview

- To view the printed pages before you print:



1. Click the **Print Preview** button. The **Select Pages** dialog box appears.

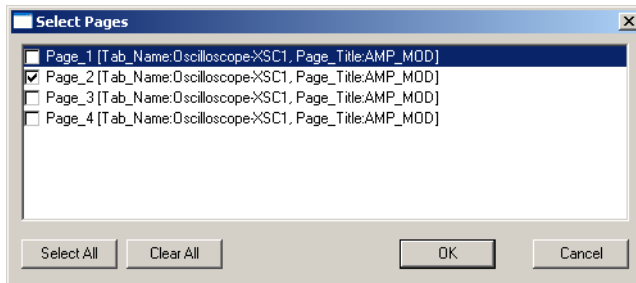

2. Select the page that you wish to view and click **OK**.
  3. Click the **Print** button to open the print dialog box and print the pages.
- or
- Click **Close** to close print preview.

- To print pages:

1. Click the **Print** button on the toolbar or from the print preview. The **Select Pages** dialog box appears.

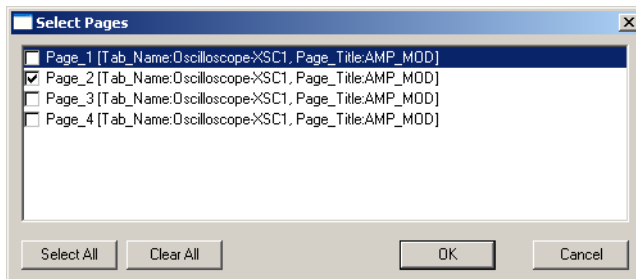

2. Select the page that you wish to print and click **OK**. The **Print** dialog box for your printer appears.
3. Enter the desired parameters and click **OK**.

**Note** Colored lines are distinguished with different line styles for black and white printers.

## 11.3 Working with Analyses

To use an analysis you should follow the general instructions for accessing and running an analysis described below. Also, each analysis has specific options that you can set:

- the analysis parameters (all have default values)
- how output variables are to be handled (required)
- a title for the analysis (optional)
- custom values for analysis options (optional).

Analysis settings are saved with the circuit.

The rest of this section describes the general procedures for performing analyses. The following sections describe the details of each particular analysis.

### 11.3.1 General Instructions



➤ To perform an analysis:

1. Select **Simulate/Analyses**. A menu appears with the list of analyses available.
2. Select the desired analysis. Depending on the analysis selected, the dialog box that appears will include some or all of the following tabs:
  - the **Analysis Parameters** tab, where you set the parameters for this analysis
  - the **Output** tab, where you specify what is to be done with specific analysis output (not present in all analyses)
  - the **Analysis Options** tab, where you set any custom values for analysis options
  - the **Summary** tab, where you see a consolidated view of all the settings for the analysis.

By default, most of the tabs display a streamlined version of the tab with just the most commonly used fields. Click **More** on the analysis dialog box to display the full dialog box displaying all available options. The options and settings available in these tabs are described in the following sections of this chapter. The examples in those sections show the full dialog box.

- To save the settings as the defaults for future use, click **Accept** on the analysis dialog box.
- To run the simulation with the current settings, click **Simulate** on the analysis dialog box.
- To stop the analysis, select **Simulate/Analyses/Stop Analysis**.
- To run several analyses in a batch, see “11.21 Batched Analyses” on page 11-123.

**Tip** To stop an analysis, press ESC.

## 11.3.2 The Analysis Parameters Tab

The options available in the **Analysis Parameters** tab are different for each analysis, and so are described in different sections of this chapter, one per analysis. Analysis descriptions include guidelines for both normal and advanced use of the analysis.

Some lists of items are accompanied by a **Change filter** function. This lets you filter the items shown in that list, choosing whether or not to include internal nodes, submodules, open pins and device parameters.

## 11.3.3 The Output Tab

This tab displays, on the left, all the possible output variables for the current circuit. You choose the variables you want to use in the analysis. By default, the tab displays just the most commonly used fields. Click **More** to display the full dialog box displaying all available options as shown in the example below.

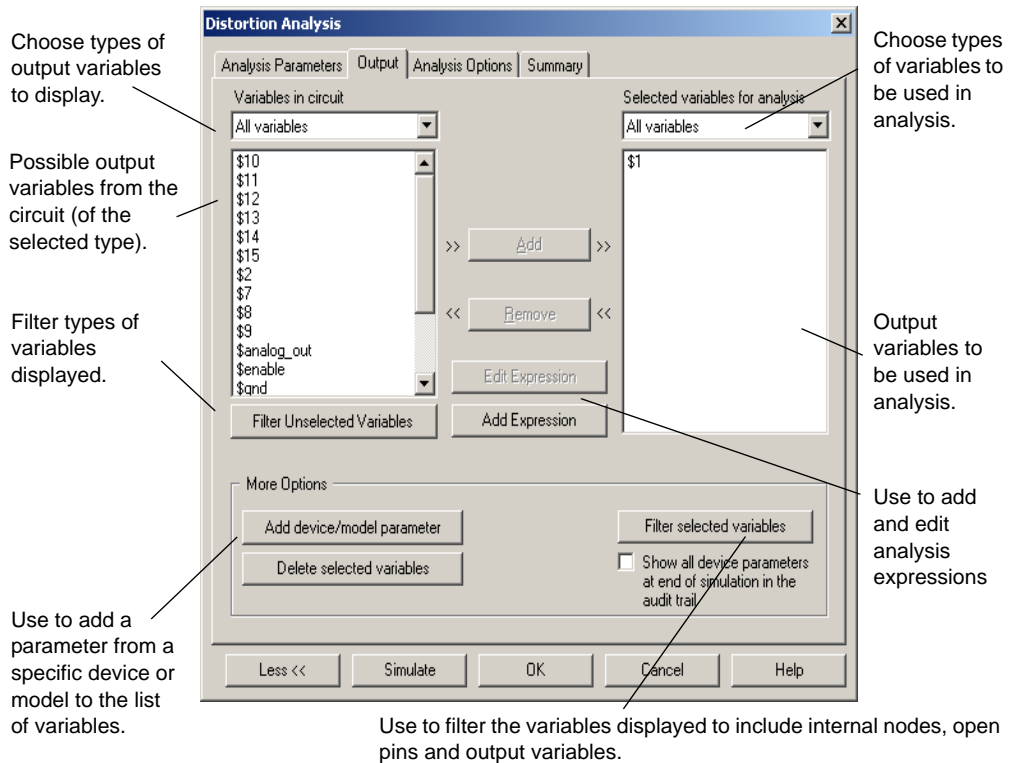



### 11.3.3.1 Choosing How Output Variables are to be Handled

- To include the output variable in the plot, select a variable from the list on the left and click **Add**.
- To select more than one variable at a time, press **SHIFT** while selecting variables from the list on the left and click **Add**.
- To remove an item from the right hand list, select it and click **Remove**.

Using the **Output** tab, you can also filter the variables list, filter the variables displayed, as well as add a wide range of device or model parameters.

By default, all variables are initially included in the **Variables in Circuit** list.

### 11.3.3.2 Filtering the Variable Lists

- To filter the variables list according to general variable type:
  1. Click the **Variables in Circuit** drop-down list.
  2. Click the general variable type (such as voltages, currents, device/model parameters) to include in the list.

You can filter the variables displayed to include internal nodes (such as nodes inside a BJT model or inside a SPICE subcircuit), open pins, as well as output variables from any submodules contained in the circuit.

- To filter the variables displayed:
  1. Click **Filter Unselected Variables**. The **Filter Nodes** dialog box appears:

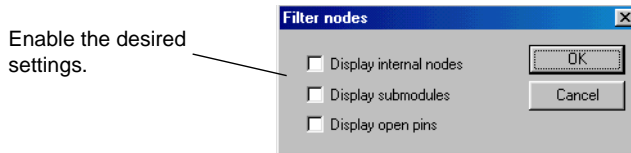

2. Enable one or more settings.
3. Click **OK**.

### 11.3.3.3 Adding Parameters to the Variable List

- To add a parameter from a specific device or model to the list of variables:
  1. Click **Add device/model parameter**. The **Add device/model parameter** dialog box appears, allowing you to specify which parameter is to be added. For example:

Choose whether to add either a device or model parameter.

2. From the **Parameter Type** list, select whether you want to add a device parameter or model parameter. These let you set how various internal parameters of a component or model change during the analysis.
3. From the **Device Type** drop-down list, select a device type from the devices in the circuit.
4. From the **Name** drop-down list, select a specific instance of the device type.
5. From the **Parameter** drop-down list, select a parameter from all available device/model parameters. A brief description of the selected parameter appears in the **Description** field.
6. Click **OK** to add the selected parameter to the **Variables in Circuit** list. This variable can now be included in the analysis.

The parameter appears in the left-hand list in the **Output Variables** tab on the analysis dialog box, which is automatically set to show only device/model parameters.

- To delete a parameter added in this way, select it and click **Delete selected variables**.
- To show the values of all the components and models in the circuit at the end of the simulation, enable **Show all device parameters at end of simulation in the audit trail**.

## 11.3.4 Adding Analysis Expressions

Expressions can be added to analyses via the **Analysis Expression** dialog box.

In the following analyses, this dialog box is accessed from the **Output** tab by clicking the **Add Expression** button:

- DC Operating Point Analysis
- AC Analysis
- Transient Analysis
- Fourier Analysis
- Distortion Analysis
- DC Sweep Analysis
- Parameter Sweep Analysis
- Temperature Sweep Analysis.

Other analyses support expressions through the **Analysis Parameters** tab. For the analyses listed below, you can click on the **Expression** checkbox and enter an analysis expression directly into the **Output Variable** field. When the **Expression** checkbox is enabled, the **Change Filter** button changes to the **Edit Expression** button. Click this to view the **Analysis Expression** dialog box where you can enter and edit analyses.

- Sensitivity Analysis
- Worst Case Analysis
- Monte Carlo Analysis.

➤ To add an expression:

1. Access the **Analysis Expression** dialog box as described above.
2. Optionally, click **Change Filter** and select any of internal nodes, submodules or open pins to add to the **Variables** list.
3. Filter the available **Variables** and **Functions** using their respective drop-down lists.
4. Build your expression by selecting the desired **Variables** and **Functions** one at a time and click the **Copy Variable to Expression** or **Copy Function to Expression** button to place them into the **Expression** field. The selection will be placed at the current cursor position.

**Tip** Instead of using the **Copy Variable to Expression** and **Copy Function to Expression** buttons, you can double-click to place them into the **Expression** field.

**Tip** To save time, you can type smaller expressions directly into the **Expression** field. (Exercise caution, as the syntax of the expression will not be checked until the analysis is performed). If you wish to remove the entire expression and start over, click **Clear**.

**Note** Available functions are the same as in the **Postprocessor**, with the exception of vector functions. Vector functions require a previously acquired set of data, and are therefore

available only via the **Postprocessor**. For details, see “12.4 Available Postprocessor Functions” on page 12-10.

5. Click **OK** to close the dialog. Depending on the analysis from which you accessed the **Analysis Expression** dialog, your expression is placed in either the **Selected Variables for Analysis** list or the **Output Variable** field.
6. From the analysis dialog box, click **Simulate**. The analysis proceeds as normal, and the traces on the resulting graph show the output equation(s) as if they are individual nodes. When you open the **Analysis Expression** dialog box again, the expression that you entered will be in the **Recent Expressions** list. Each time you add an expression in the current Multisim session, it will be added to this list.

**Tip** To save time entering expressions that are similar to those already used, highlight a similar expression in the **Recent Expressions** list and click **Copy to Expression**. Now edit the contents of the **Expression** field as desired. If you wish to remove an expression from the **Recent Expressions** list, highlight it and click **Delete Selected**.

**Note** If you run the **Postprocessor** on this analysis, the expression and all of its dependant circuit variables are available for postprocessing.

➤ To edit an expression from an analysis:

1. Highlight it in the **Selected Variables for Analysis** list and click **Edit Expression** to display the **Analysis Expression** dialog box.

**Note** If the analysis displays the expression in the **Output Variable** field, there is no need to highlight it before clicking **Edit Expression**.

2. Edit the expression as desired and click **OK** to return to the analysis.

➤ To delete an expression from an analysis:

1. Highlight the expression in the **Selected Variables for Analysis** list and click **Remove**. Removing an expression deletes it entirely.

*Or*

If the analysis displays the expression in the **Output Variable** field, click **Edit Expression** to display the **Analysis Expression** dialog box and click **Clear**, then **OK** to close the dialog. The **Output Variable** field in the analysis is now empty.

You can also highlight the entire expression in the **Output Variable** field, and click **DELETE** on your keyboard.

## 11.3.5 The Analysis Options Tab

The options in this tab provide you with additional flexibility, but do not require that you set them. Use this tab to set a title for the analysis results, to check if the circuit is valid for analysis, and to set custom analysis options. You can also set custom SPICE options.

To set custom SPICE options, enable this option...

...and click the Customize button. The Analysis Options dialog appears. For details, see “11.23 Analysis Options dialog box” on page 11-129.

To check if the circuit is valid for analysis, enable this option.

The title appears on the plot produced by the analysis, and is recorded in the audit trail.

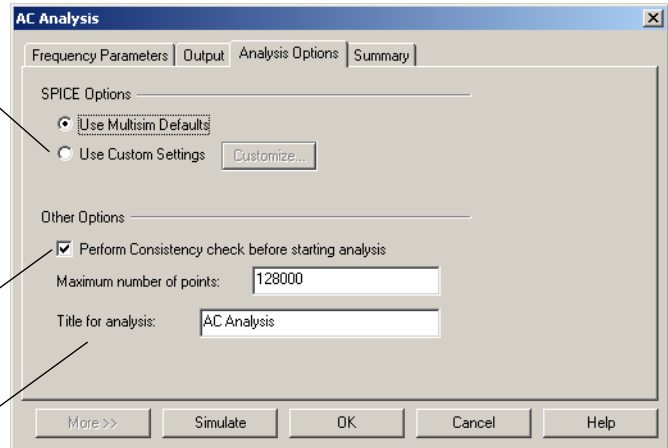

- To check if the circuit is a valid circuit for analysis, enable **Perform consistency check before starting analysis**. This option automatically identifies inconsistencies such as open capacitors, empty circuit files and ungrounded circuits.

Normally analyses run without further intervention. If an analysis does not perform as necessary, you may need to set custom analysis options.

- To change the analysis title from its default, enter text in the **Title for analysis** field.
- To set custom analysis options:
  1. Enable **Use Custom Settings** and click **Customize**. The **Analysis Options** dialog box appears.
 

**Note** You should have a general knowledge of the SPICE simulation engine before altering the default settings under this option.
  2. Change the desired settings in the **Analysis Options** dialog box.
  3. Click **OK** to return to the **Analysis Options** tab.
  4. To save your changes, click **OK**. To close without saving, click **Cancel**.

For a complete list of the available analysis options, see “11.23 Analysis Options dialog box” on page 11-129.

## 11.3.6 The Summary Tab

This tab offers a quick overview of the various settings for your analysis. It does not require you to set any options, but you can use it to view summary information about your analysis. By default, the tab displays just the most commonly used fields. Click **More** to display the full dialog box as shown in the example below.

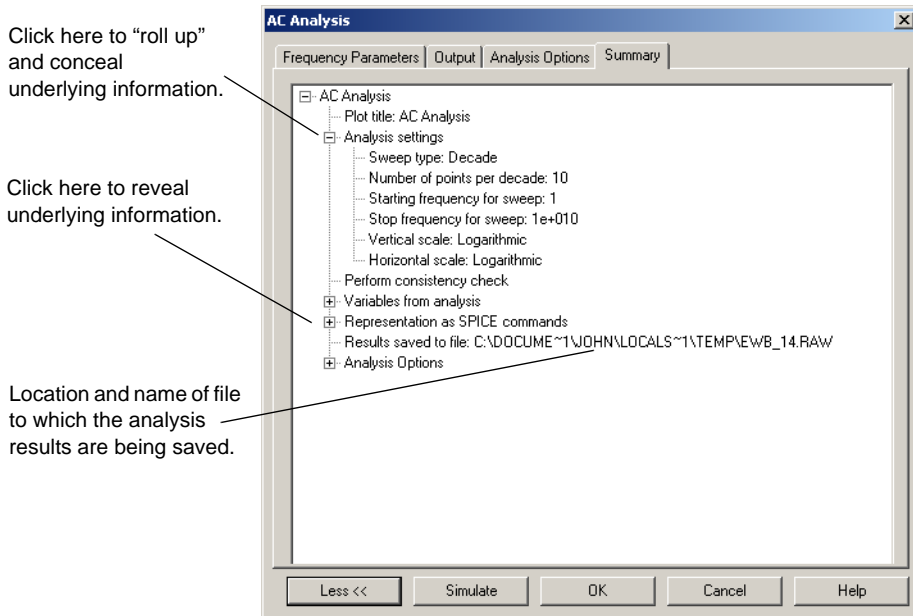

You navigate through this display as you do with Windows Explorer. The “+” beside an item indicates that it has additional information underneath it, which can be revealed by clicking the “+”. The “-” beside an item indicates that all its information is being revealed. That information can be hidden by clicking the “-”.

This window also shows you the SPICE representation of your analysis options, as well as the name of the file to which the analysis results are being saved (.raw file). This file is used for Postprocessing.

## 11.3.7 Incomplete Analyses

For a variety of reasons, the simulator in Multisim is occasionally unable to complete a simulation or an analysis.

Multisim uses the modified Newton-Raphson method to solve nonlinear circuits. When a circuit includes nonlinear components, multiple iterations of a set of linear equations are used to account for the non-linearities. The simulator makes an initial guess at the node voltages, then calculates the branch currents based on the conductances in the circuit. The branch currents are then used to recalculate the node voltages and the cycle is repeated. This cycle continues until all of the node voltages and branch currents fall within user-defined tolerances, that is, convergence occurs. You can specify tolerances and iteration limits for the analysis through the analysis options described in “11.23 Analysis Options dialog box” on page 11-129.

If the voltages or currents do not converge within a specified number of iterations, an error message is produced and the simulation is aborted (typical messages include “Singular matrix,” “Gmin stepping failed,” “Source stepping failed” and “Iteration limit reached”).

## 11.4 DC Operating Point Analysis

### 11.4.1 About the DC Operating Point Analysis

**DC Operating Point Analysis** determines the DC operating point of a circuit. The results of DC analysis are usually intermediate values for further analysis. For example, the results obtained from DC analysis determines the approximate linearized, small-signal models for any nonlinear components, such as diodes and transistors, to be used with AC frequency analysis.

Assumptions:

- AC sources are zeroed out
- Capacitors are open
- Inductors are shorted
- Digital components are treated as a large resistor to ground.

### 11.4.2 Setting up and Running DC Operating Point Analysis

- To start **DC Operating Point Analysis**, select **Simulate/Analyses/DC Operating Point**.

In the **DC Operating Point Analysis** dialog box, several tabs are available. These are discussed in the following section.

### 11.4.2.1 Setting DC Operating Point Analysis Parameters

There are no analysis parameters to be set for this analysis. Hence, the **Analysis Parameters** tab does not appear for **DC Operating Point Analysis**.

For details on the other tabs in the analysis window, see “11.3 Working with Analyses” on page 11-23.

### 11.4.3 Sample Circuit

This example analyses the DC Operating Point results at Node #3.

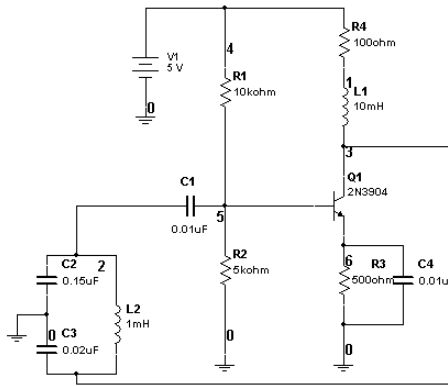

The circuit above is a Colpitts oscillator. When running DC Operating Point Analysis, Multisim reduces the circuit to that shown below:

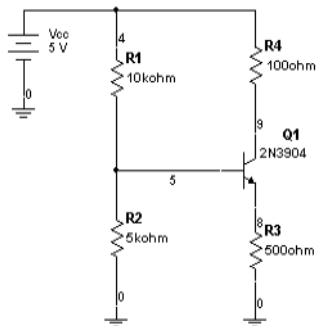

Calculating output voltage at node 9:

$$V_{base} = V_1 * R_2 / (R_1 + R_2) = 1.67V \quad (\text{Base Voltage of Q1})$$

$$V_e \approx 1.67 - 0.7 = 0.966V \quad (\text{Emitter Voltage of Q1})$$

$$I_e = V_e / R_3 = 1.9mA \quad (\text{Emitter Current of Q1})$$

$$I_e \approx I_c$$

$$V_{out} = V_{cc} - I_c * R_4 \approx 4.81$$



The result of running DC operating point from the sample circuit are shown below. Note that the results match the calculations made in the diagram above.

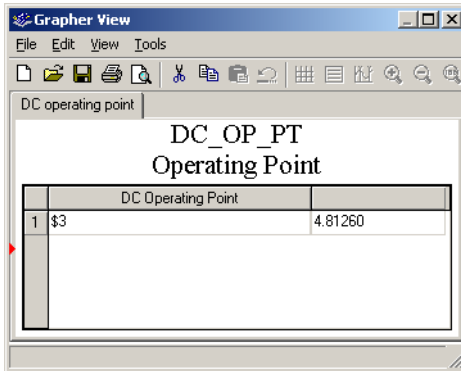

DC Operating Point	
1	\$3 4.81260

## 11.4.4 Troubleshooting DC Operating Point Analysis Failures

**DC Operating Point Analysis** may fail to converge for various reasons. The initial guesses for the node voltages may be too far off, the circuit may be unstable or bi-stable (there may be more than one solution to the equations), there may be discontinuities in the models or the circuit may contain unrealistic impedances.

### 11.4.4.1 Circuit failure example

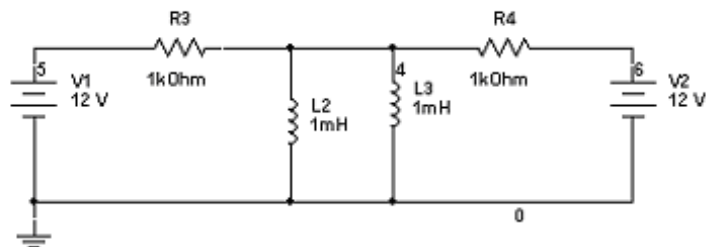

When current flows through an inductor, voltage will develop across the terminals. SPICE models inductors as time-varying current sources. When a circuit has two inductors in parallel, the simulator engine will automatically produce an error. When running any analysis

for the circuit above, the two inductors are seen as voltage sources by the simulation engine. As a result, this circuit will fail.

To correct this problem, simply place a 0.001ohm resistor in the circuit. The sources are no longer in parallel, and the DC operating point can converge.

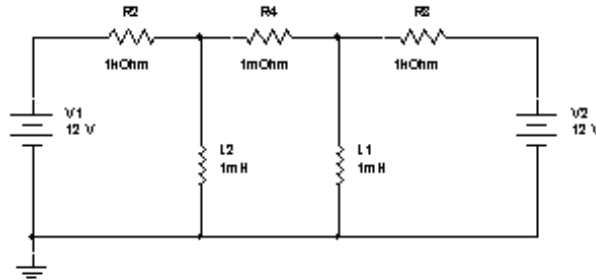

### 11.4.4.2 Trouble-shooting Techniques

Use the following techniques to solve many convergence problems and analysis failures. Before you proceed, identify which analysis is causing the problem (keep in mind that **DC Operating Point Analysis** is often performed as the first step of other analyses). In each of the following solutions, begin with step 1, then continue performing the subsequent steps, in order, until the problem is solved.

1. Check the circuit topology and connectivity. Make sure that:
  - the circuit is grounded.
  - the circuit is correctly wired, and includes no dangling nets or stray parts.
  - you haven't confused zeroes with the letter O.
  - the circuit has a ground node and every node in the circuit has a DC path to ground. Make sure no sections of your circuit are completely isolated from ground by transformers, capacitors, etc.
  - Capacitors and voltage sources are not in parallel.
  - Inductors and current sources are not in series.
  - All devices and sources are set to their proper values.
  - All dependent source gains are correct.
  - Your models/subcircuits have been correctly entered.
2. Show all net names (**Options/Sheet Properties -> Circuit tab**). Check the net name assigned to ground components. All grounds **MUST** be indicated by net name 0 (ZERO). If otherwise, delete a ground and replace by another one from the parts bin.

3. Check for duplicate net names in the circuit. Each net must have a unique name. Reassign if necessary by double-clicking the wire indicating a duplicate net name and typing in another unique name.
4. If working with digital circuits make sure that both, earth and digital grounds are left on the workspace.
5. Copy and then paste your circuit into a new file. Simulate the circuit again.

If the problem persists, adjust the following parameters:

1. From the **Analysis Options** tab of the **DC Operating Point** dialog box, enable **Use Custom Setting** and click **Customize**. The **Analysis Options** dialog box appears.
2. In the **Global** tab:
  - Reduce the RSHUNT value by a factor of 100
  - Increase the GMIN minimum conductance by a factor of 10. Note:  $GMIN = 1/Rp$ , where Rp is the smallest parasitic resistance value in the circuit.
3. In the **DC** tab:
  - Set  $ITL1 = 500$  or more. By increasing ITL1, the extra iterations will only be used if they are needed. ITL1 set to 1000 covers about 90% of circuits
  - Set  $ITL6 = 500$
4. Use `.Nodeset` to set a DC voltage level if possible (double-click wire connected to a net in question. Check “**Use NODESET for DC**” and type in a DC voltage).

---

**Caution** When running **DC Operating Point Analysis** for a circuit that contains ammeters and voltmeters (indicators) and their internal settings (resistance) have been changed from their default values, the simulation results indicated by **DC Operating Point Analysis** will be incorrect. Remove ammeters/voltmeters to correct the problem. The results are correct if no changes were applied to ammeter/voltmeter internal settings.

---

## 11.5 AC Analysis

### 11.5.1 About the AC Analysis

**AC Analysis** is used to calculate the frequency response of linear circuits. In **AC Analysis**, the DC operating point is first calculated to obtain linear, small-signal models for all nonlinear components. Then a complex matrix (containing both real and imaginary components) is

created. To construct a matrix, DC sources are given zero values. AC sources, capacitors, and inductors are represented by their AC models. Nonlinear components are represented by linear AC small-signal models, derived from the DC operating point solution. All input sources are considered to be sinusoidal. The frequency of the sources is ignored. If the function generator is set to a square or triangular waveform, it will automatically switch internally to a sinusoidal waveform for analysis. **AC Analysis** then calculates the AC circuit response as a function of frequency.

**Assumptions** Applied to an analog circuit, small-signal. Digital components are treated as large resistances to ground.

## 11.5.2 Setting AC Analysis Frequency Parameters

Before you perform the analysis, review your circuit and decide on the nets for analysis. You can specify magnitude and phase of a source for AC frequency analysis by double-clicking on the source and entering the settings in the **Value** tab of the properties dialog box. Enter your settings for **AC Analysis Magnitude** and **AC Analysis Phase** as shown below. The other settings in this dialog box are used for other analyses or for simulating with the instruments.

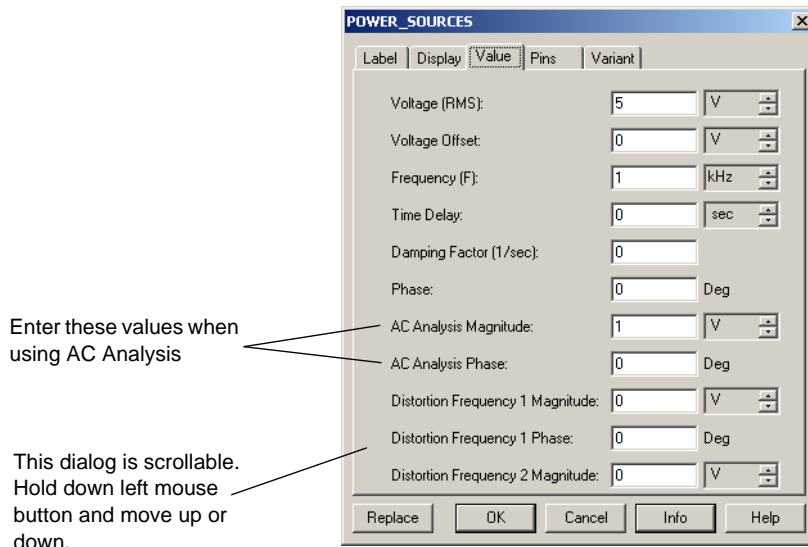

AC Analysis frequency parameters are set in the following dialog box:

Enter the start frequency for the sweep.

Enter the stop frequency for the sweep.

Select a sweep type: decade, linear, or octave. Defines how points to be calculated are distributed across the frequency range.

Enter the number of points to be calculated during the analysis. For a linear sweep type, use the number of points between start and end.

Select a vertical scale: linear, logarithmic, decimal, or octave. Vertical scale controls the y-axis scaling on the output graph.

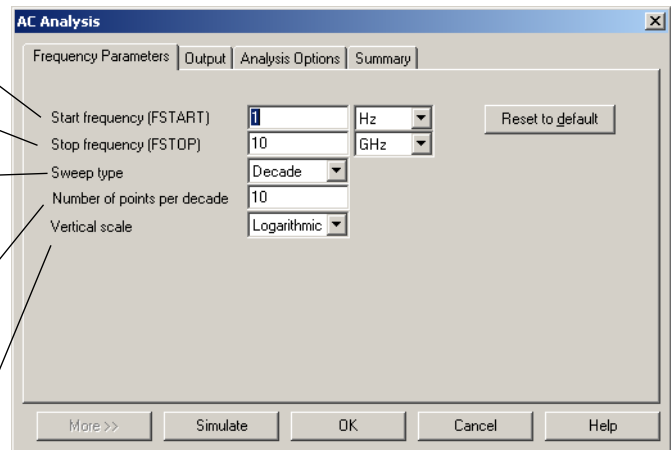

**Note** To reset all parameters to their default values, click **Reset to default**.

The result of the AC frequency analysis is displayed in two parts: gain versus frequency and phase versus frequency.

If you have the Bode plotter connected to your circuit and activate the circuit, a similar analysis is performed.

## Setting AC Analysis Frequency Parameters for Normal Use

In most cases, you only need to:

- set a **Start Frequency (FSTART)**
- set a **Stop Frequency (FSTOP)**

## Setting AC Analysis Frequency Parameters for Advanced Use

In addition to the frequency range, you can also:

- choose a desired sweep type (decade, linear, or octave) from the **Sweep type** drop-down list
- enter the number of points to be calculated in the **Number of points per decade** field
- choose the vertical scale (linear, logarithmic, decimal or octave) from the **Vertical scale** drop-down list.

**Note** The greater the number of points calculated, the more accurate the results will be; however, the simulation speed will be adversely affected.

## 11.6 Transient Analysis

### 11.6.1 About the Transient Analysis

In transient analysis, also called time-domain transient analysis, Multisim computes the circuit's response as a function of time. Each input cycle is divided into intervals, and a DC analysis is performed for each time point in the cycle. The solution for the voltage waveform at a node is determined by the value of that voltage at each time point over one complete cycle.

**Assumptions** DC sources have constant values; AC sources have time-dependent values. Capacitors and inductors are represented by energy storage models. Numerical integration is used to calculate the quantity of energy transfer over an interval of time.

### 11.6.2 Setting Transient Analysis Parameters

Before you perform the analysis, review your circuit and decide on the nets for analysis.

**Transient Analysis** parameters are set in the following dialog box:

**Note** If your dialog box does not look like the example below, click **More** to display the full analysis dialog box.

Set initial conditions: Set to Zero, User-Defined, Calculate DC Operating Point, or Automatically Determine Initial Conditions.

Start time of transient analysis must be greater than or equal to 0 and less than End time.

End time of transient analysis must be greater than Start time.

Click to enter minimum number of time points (number of points between start and stop times).

Click to enter the maximum time step the simulation can handle.

Click to generate time steps automatically.

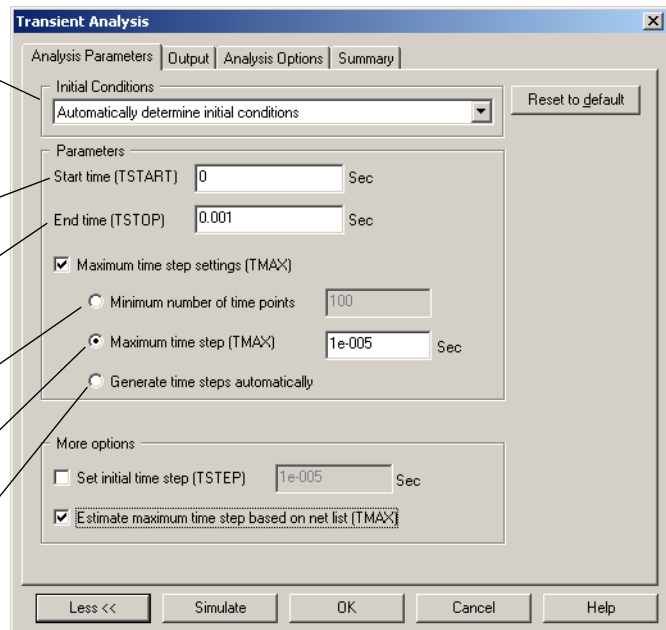

The result of the transient analysis is a calculation of voltage versus time.

If you have the oscilloscope connected to your circuit and activate the circuit, a similar analysis is performed.

**Note** To re-set all parameters to their default values, click **Reset to default**.

if initial conditions are set to...	then...
Automatically determine initial conditions	Multisim tries to start the simulation using the DC operating point as the initial condition. If the simulation fails, it uses user-defined initial conditions.
Calculate DC operating point	Multisim first calculates the DC operating point of the circuit, then uses that result as the initial conditions of the transient analysis.
Set to zero	the transient analysis starts from zero initial conditions.
User-defined	the analysis starts from initial conditions as set in the Transient Analysis dialog box.

### Setting Transient Analysis Parameters for Normal Use

The default settings are appropriate for normal use, providing the transient response of the selected output variables starting at time 0 seconds and stopping after 1 ms (0.001). You can, if you wish:

- change the start time by entering a value greater than or equal to 0 and less than the End time in the **Start time (TSTART)** field
- change the end time by entering a value greater than the Start time in the **End time (TSTOP)** field.

### Setting Transient Analysis Parameters for Advanced Use

For advanced use, you can:

- define the initial conditions at time 0 seconds by selecting an initial condition (Set to Zero, User-Defined, Calculate DC Operating Point, or Automatically Determine Initial Conditions) from the **Initial conditions** drop-down list

You can have the initial conditions set to zero, or you can use the steady state values of the circuit under analysis. During and/or after circuit construction, you can specify node voltages. These forced values can also be used as initial conditions for the analysis.

If you select “Automatically determine initial conditions”, Multisim will attempt to use steady state conditions to run the analysis. If this is unsuccessful, Multisim will set initial

conditions to zero. If simulation is still not possible, Multisim will use the specified user-defined conditions.

- define the maximum time step to be taken by the simulation engine by enabling **Maximum time step (TMAX)** and entering the desired time step
- define the minimum time step to be taken by enabling **Minimum number of time points** and entering the desired number of points to be calculated

The value of TMAX is determined by dividing the interval between the specified analysis start and end times by the minimum number of time points specified.

- enable **Set Initial Time step (TSTEP)**, and enter a value less than the specified maximum time step value in the **Time step (TSTEP)** field. If possible, the size of the time steps taken during the simulation will begin with the initial timestep and will continue to increase to the value specified by the maximum time step.

### 11.6.3 Troubleshooting Transient Analysis Failures

If transient analysis is being performed (time is being stepped) and the simulator cannot converge on a solution using the initial time step, the time step is automatically reduced, and the cycle is repeated. If the time step is reduced too far, an error message (“Timestep too small”) is generated and the simulation is aborted. If this occurs, try one or more of the following:

- Check the circuit topology and connectivity. See step 1 of “11.4.4 Troubleshooting DC Operating Point Analysis Failures” on page 11-33.
- Set relative error tolerance to 0.01. By increasing the tolerance from 0.001 (0.1% accuracy), fewer iterations are required to converge on a solution and the simulation finishes much more quickly.
- Increase transient time point iterations to 100. This allows the transient analysis to go through more iterations for each time step before giving up.
- Reduce the absolute current tolerance, if current levels allow. Your particular circuit may not require resolutions down to 1  $\mu\text{V}$  or 1  $\text{pA}$ . You should allow at least an order of magnitude below the lowest expected voltage or current levels of your circuit.
- Realistically model your circuit. Add realistic parasitics, especially junction capacitances. Use RC snubbers around diodes. Replace device models with subcircuits, especially for RF and power devices.
- If you have a controlled one-shot source in your circuit, increase its rise and fall times.
- Change the integration method to Gear. Gear integration requires longer simulation time, but is generally more stable than the trapezoid method.



## 11.7 Fourier Analysis

### 11.7.1 About the Fourier Analysis

Fourier analysis is a method of analyzing complex periodic waveforms. It permits any nonsinusoidal period function to be resolved into sine or cosine waves (possibly an infinite number) and a DC component. This permits further analysis and allows you to determine the effect of combining the waveform with other signals.

Given the mathematical theorem of a Fourier series, the period function  $f(t)$  can be written as follows:

$$f(t) = A_0 + A_1 \cos \omega t + A_2 \cos 2\omega t + \dots + B_1 \sin \omega t + B_2 \sin 2\omega t + \dots$$

where:

$A_0$	=	the DC component of the original wave
$A_1 \cos \omega t + B_1 \sin \omega t$	=	the fundamental component (has the same frequency and period as the original wave)
$A_n \cos n\omega t + B_n \sin n\omega t$	=	the $n^{\text{th}}$ harmonic of the function
$A, B$	=	the coefficients
$\frac{2\pi}{T}$	=	the fundamental angular frequency, or $2\pi$ times the frequency of the original periodic wave

Each frequency component (or *term*) of the response is produced by the corresponding harmonic of the periodic waveform. Each term is considered a separate source. According to the principle of superposition, the total response is the sum of the responses produced by each term. Note that the amplitude of the harmonics decreases progressively as the order of the harmonics increases. This indicates that comparatively few terms yield a good approximation.

When Multisim performs Discrete Fourier Transform (DFT) calculations, only the second cycle of the fundamental component of a time-domain or transient response (extracted at the output node) is used. The first cycle is discarded for the settling time. The coefficient of each harmonic is calculated from the data gathered in the time domain, from the beginning of the cycle to time point “t”. That is set automatically and is a function of the fundamental frequency. This analysis requires a fundamental frequency matching the frequency of the AC source or the lowest common factor of multiple AC sources.

**Assumptions** None.

## 11.7.2 Setting Fourier Analysis Parameters

Before you perform the analysis, review your circuit and select an output node in the dialog box. The output variable is the node from which the analysis extracts the voltage waveform. Fourier Analysis parameters are set in the following dialog box:

**Note** If your dialog box does not look like the example below, click **More**.

Set to the frequency of an AC source in your circuit. If you have several AC sources, use the lowest common factor of frequencies. Click to have fundamental frequency estimated.

Set the number of harmonics of the fundamental frequency that are calculated.

Click to set parameters for associated transient analysis.

Enable to display results as phase.

Enable to display results as bar graph. If not enabled, results display as linegraph.

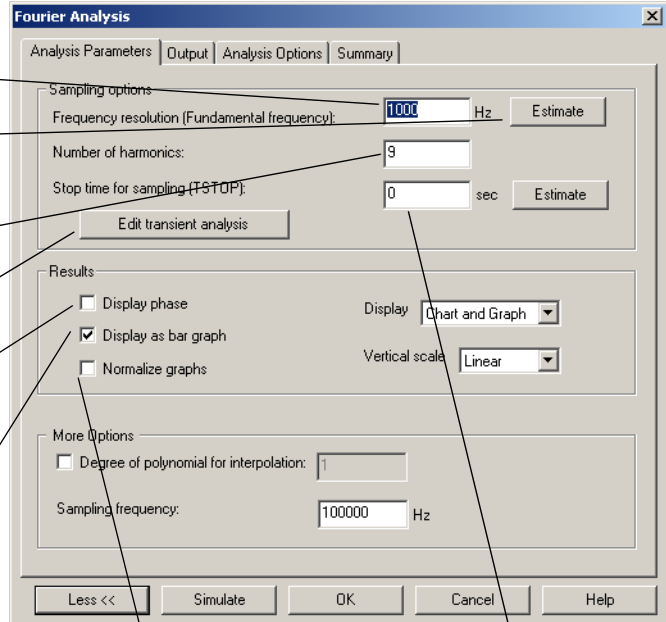

Enable to normalize graphs. Normalized graphs are normalized against the 1st harmonic.

Set the amount of time during which sampling should occur (or use Edit Transient Analysis).

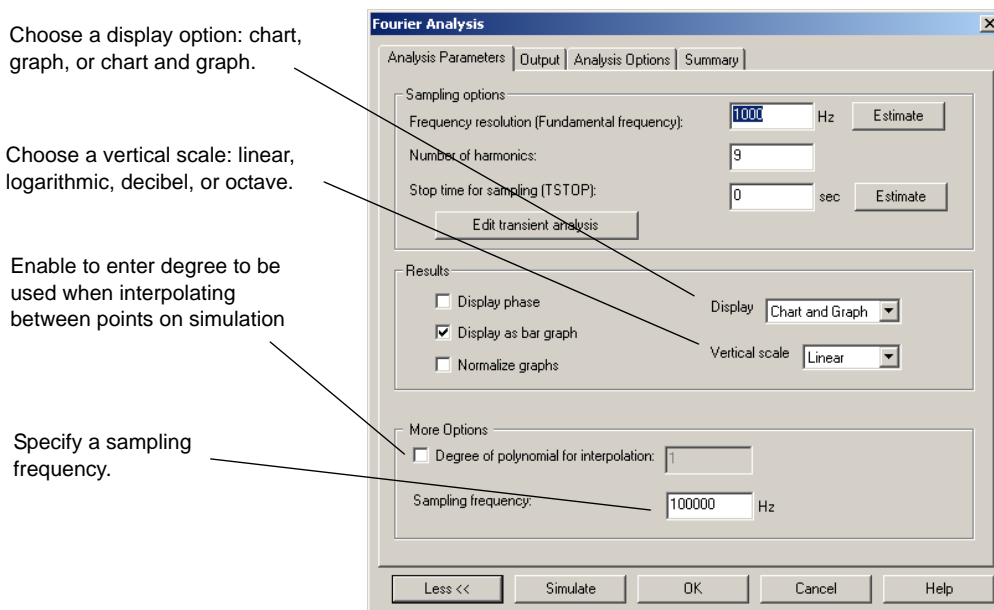

Choose a display option: chart, graph, or chart and graph.

Choose a vertical scale: linear, logarithmic, decibel, or octave.

Enable to enter degree to be used when interpolating between points on simulation

Specify a sampling frequency.

Fourier analysis produces a graph of Fourier voltage component magnitudes and, optionally, phase components versus frequency. By default, the magnitude plot is a bargraph but may be displayed as a line graph.

The analysis also calculates Total Harmonic Distortion (THD) as a percentage. The THD is generated by notching out the fundamental frequency, taking the square root of the sum of the squares of each of the  $n$  harmonics, and then dividing this number by the magnitude of the notched out fundamental frequency.

$$\text{THD} = [(\sum_{i=2}^n V_i^2) / V_1] \times 100 \%$$
, where  $V_1$  is the magnitude of the  $i^{\text{th}}$  harmonics.

### Setting Fourier Analysis Parameters for Normal Use

For normal use, you just need to specify parameters for the following:

- frequency under test, either by clicking **Estimate** to have a value selected based on the AC sources in the circuit, or by entering a value in the **Frequency resolution (Fundamental frequency)** field. This value should be the lowest common factor for the frequencies present in the circuit.
- number of harmonics, by entering a value in the **Number of harmonics** field. You can specify the stopping time for sampling to avoid unwanted transient results prior to the circuit reaching steady-state operation.
- stopping time for sampling by enabling **Stop time for sampling (TSTOP)** and entering a new

stopping time for sampling. Although the Nyquist rate specifies only two times the highest frequency component being considered in the analysis as a suitable sampling rate, it is recommended that you specify a sampling frequency sufficient to obtain a minimum of 10 sampling points per period.

- enter a value in the **Sampling Frequency** field.

**Note** The sampling frequency should be equal to the frequency resolution (the number of harmonics plus one) multiplied by at least 10.

## Setting Fourier Analysis Parameters for Advanced Use

In addition to the basic procedures, you can also specify parameters for the following:

- degree of polynomial for interpolation, by enabling **Degree of polynomial for interpolation** and entering a value in the appropriate field. The higher the degree of polynomial the greater the accuracy of the results.
- results display format by doing one or all of the following:
  - choosing a vertical scale (linear, logarithmic, decibel or octave) from the **Vertical Scale** list
  - choosing a display option (chart, graph, or chart and graph) from the **Display** list
  - enabling **Display phase** to display results as phase
  - enabling **Display as bar graph** to display the results as a bar graph instead of a linegraph.
  - enabling **Normalize graphs** to normalize the results with respect to the frequency under test.
- transient analysis options by clicking **Edit transient analysis** to edit the transient analysis setup. For details, see “Setting Transient Analysis Parameters for Normal Use” on page 11-39.

## 11.8 Noise Analysis

### 11.8.1 About the Noise Analysis

Noise is electrical or electromagnetic energy that reduces the quality of a signal. Noise affects digital, analog and all communications systems. Multisim creates a noise model of the circuit, using noise models of each resistor and semiconductor device, instead of AC models and then performs AC-like analysis. It calculates the noise contribution of each component and propagates it to the output of the circuit sweeping through the frequency range specified in the analysis dialog box.

Noise analysis calculates the noise contribution from each resistor and semiconductor device at the specified output node. Each resistor and semiconductor device is considered a noise generator. Each noise generator's contribution is calculated and propagated by the appropriate transfer function to the output of the circuit. The "total output noise" at the output node is the RMS (Root Mean Square) sum of the individual noise contribution. The result is then divided by the gain from input source to the output source to get the "equivalent input noise". This is the amount of noise which, if injected at the input source into a noiseless circuit, would cause the previously calculated amount of noise at the output. The "total output noise" voltage can be referenced to ground or it may be referenced to another node in the circuit. In this case the total output noise is taken across these two nodes.

Multisim can model three different kinds of noise:

1. **Thermal noise** (also known as *Johnson*, or *white* noise) is temperature dependent and caused by the thermal interaction between free electrons and vibrating ions in a conductor. Its frequency content is spread equally throughout the spectrum.

The power of this generated noise is given by Johnson's formula:

$$P = k \times T \times BW$$

where

$$k = \text{Boltzmann's constant } (.38 \times 10^{-23} \text{ J/K})$$

$$T = \text{resistor temperature in Kelvin } (T = 273 + \text{temperature in Celsius})$$

$$BW = \text{frequency bandwidth of the system being considered}$$

The thermal voltage could be represented by a mean-square voltage source in series with the resistor

$$v^2 = 4kTR \times BW$$

or the resistor mean-square current generator

$$i^2 = 4kTBW/R.$$

2. **Shot noise** is caused by the discrete-particle nature of the current carriers in all forms of semiconductors. It is the major cause of transistor noise. The equation for shot noise in a diode is:

$$i = (2q \times I_{dc} \times BW)^{1/2}$$

where

$$i = \text{shot noise (RMS amperes)}$$

$$q = \text{electron charge } (1.6 \times 10^{-19} \text{ Coulombs})$$

$$I_{dc} = \text{DC current (A)}$$

$$BW = \text{bandwidth (Hz)}$$

For all other devices, such as transistors, no valid formula is available. See the device manufacturer's data sheet. Shot noise and thermal noise are additive.

3. **Flicker noise** is usually generated by BJTs and FETs and occurs in frequencies below 1 KHz. This is type of noise is also known as excess noise or pink noise. It is inversely proportional to frequency and directly proportional to temperature and DC current levels.

$$V^2 = k * I_{dc} / f$$

A component's noise contribution is determined by its SPICE model. Within the model two parameters will affect the output of the noise analysis:

- AF = Flicker noise component (AF= 0)
- KF = Flicker Noise (KF=1).

## 11.8.2 Setting Noise Analysis Parameters

Before you perform the analysis, review your circuit and decide on an input noise reference source, output node and reference node.

Noise Analysis parameters are set in the following dialog box:

Choose an AC voltage source as input.

This is the node at which all noise contributions will be summed.

Reference voltage

When enabled, generates a trace of the selected component's noise contribution. Number of frequency steps is divided by the points per summary, which reduces the resolution of the output graph.

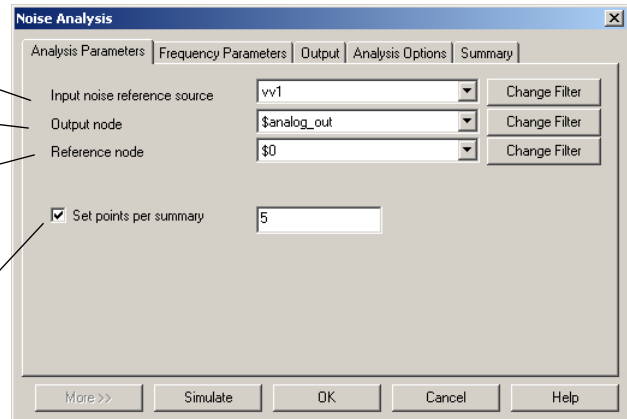

### Setting Noise Analysis Parameters for Normal Use

Noise analysis performs an AC analysis to determine the noise. Noise analysis produces an output noise spectrum, an input noise spectrum and, optionally, a component contribution spectrum. When the analysis is finished, its results are displayed as a graph of voltage squared,  $V^2$ , versus frequency.

In the **Analysis Parameters** tab, specify:

- **Input noise reference source**
- **Output node**
- **Reference node.**

By default, Multisim will only display nodes that are part of the current page.

➤ To display nodes contained within subcircuits or hierarchical blocks,

1. Click **Change Filter** and select **Display submodules**. All three filter options are explained below.

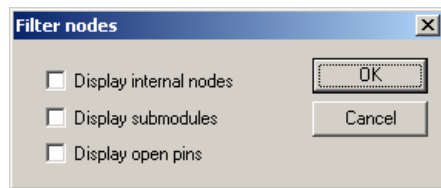

Choose one of the three options below:

- **Display internal nodes**—displays nodes within hierarchical blocks and subcircuits.
- **Display submodules**—displays components within semiconductor devices, determined by the SPICE model of the semiconductor device.
- **Display open pins**—displays all unconnected nodes of the circuit.

## Setting Noise Analysis Parameters for Advanced Use

In the **Analysis Parameters** tab you can specify how often the noise contributions of each noise generating device are produced by enabling **Set points per summary** and entering a value.

## Setting Noise Analysis Frequency Parameters

Noise Analysis Frequency Parameters are set in the following dialog box:

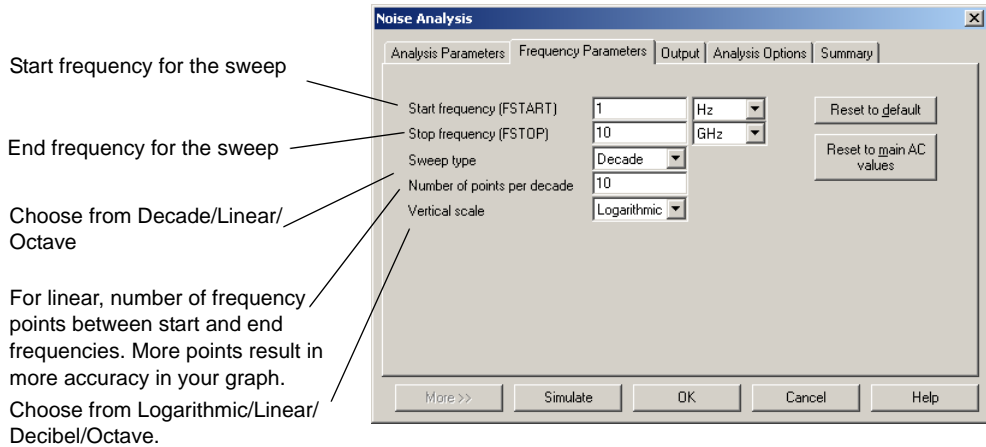

## Setting Noise Analysis Frequency Parameters for Normal Use

The default settings in the **Frequency Parameters** tab are appropriate for most cases. You just need to define a frequency range by typing a value in the **Start Frequency (FSTART)** field and in the **Stop Frequency (FSTOP)** field.

- To copy the settings from the current AC analysis to this analysis, click **Reset to main AC values**.

Once the required variables are selected and the frequency range has been defined, you can then run the analysis.

## Setting Noise Analysis Frequency Parameters for Advanced Use

In the **Frequency Parameters** tab you can also set:

- sweep type, by choosing the desired sweep type (decade, linear, or octave) from the **Sweep type** drop-down list. The sweep type defines how the points to be calculated are distributed across the frequency range.
- the number of points to be calculated during the analysis, by entering a value in the **Number of points per decade** field.

**Note** The greater the number of points calculated, the more accurate the results will be, however, the simulation speed will be adversely affected.

- the format of the analysis results by choosing the desired scale (linear, logarithmic, decimal, or octave) from the **Vertical scale** drop-down list.



**Note** Click **Reset to Default** to reset all parameters in the **Frequency Parameters** tab to their default values.

For details on other tabs in the **Noise Analysis** dialog box, see “11.3 Working with Analyses” on page 11-23.

## 11.8.3 Noise Analysis Example

The circuit below is a basic operational amplifier with a gain of 5. For this analysis, we will obtain the results for the noise voltage for R1 and R2 and display the graph of the noise spectrum across a frequency range between 10 Hz and 10 GHz.

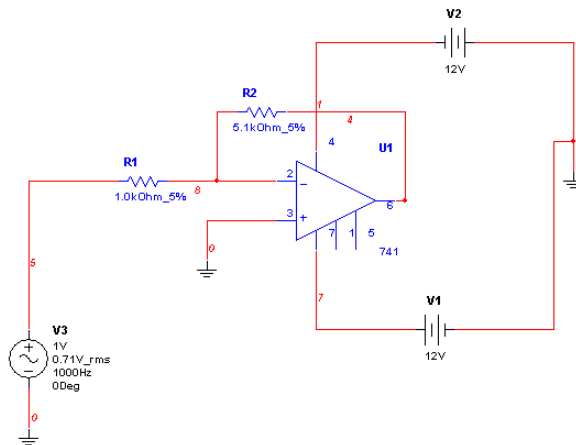

### Expected Results

The calculations below will determine what kind of output we are to expect:

If  $R1=1\text{Kohm}$ , then:

$$\begin{aligned} \text{noise} &= 4rkTB \\ &= 4(1000\Omega)(1.38 * 10^{-23})(295K)(10^9 \text{ Hz}) \\ &= 162 \text{ nV}^2 \end{aligned}$$

If  $R2=5\text{kOhm}$  then

$$\begin{aligned} \text{noise} &= 4rkTB \\ &= 4(5000\Omega)(1.38 * 10^{-23})(295K)(10^9 \text{ Hz}) \\ &= 814 \text{ nV}^2 \end{aligned}$$

### Multisim Analysis

- To set-up the analysis in Multisim:
    1. Select **Simulate/Analyses/Noise Analysis**.
    2. Select the **Analysis Parameters** tab and set the following:
      - **Input noise reference source**—vv3
      - **Output node**—4
      - **Reference node**—0
    3. Select the **Frequency Parameters** tab, and set the following:
      - **FSTART**—1Hz
      - **FSTOP**—10GHz
      - **Sweep type**—Decade
      - **Number of points per decade**—5
      - **Vertical Scale**—Logarithmic
    4. Select the **Output** tab, select the following variables for plot during simulation:
      - innoise\_total\_rr1 & innoise\_total\_rr2
- Note** It is not necessary to add any devices/model parameters to our list of variables for this example.
5. Click **Simulate**. The following displays.

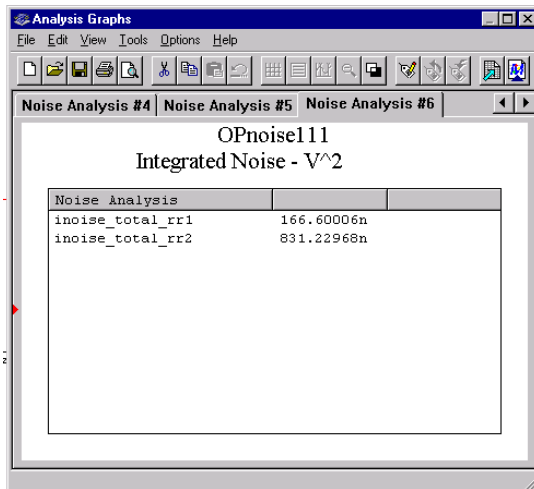

Note that the final results are similar to the expected results.

- To view the traces, you must re-initiate the analysis:
  1. Select **Simulate/Analyses/Noise Analysis**.
  2. In the **Analysis Parameters** tab, enable **Set points per summary** and enter 5 in the field.
  3. In the **Output** tab select the following variables to plot during simulation:
    - onoise\_rr1 & onnoise\_rr2
  4. Click **Simulate**. The **Grapher** displays as follows:

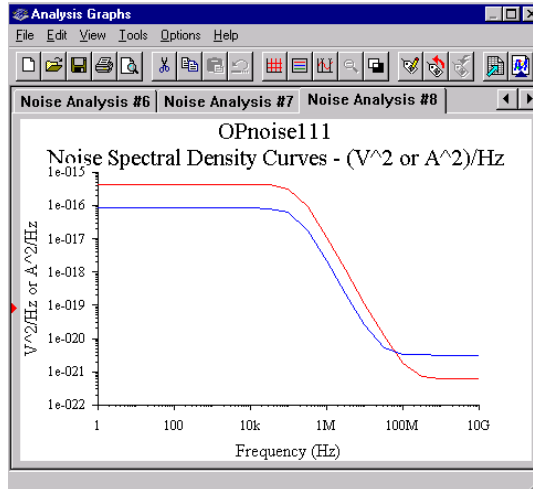

This graph shows that the noise voltage is constant for lower frequencies. For higher frequencies the noise voltage drops considerably.

## 11.9 Distortion Analysis

A perfectly linear amplifier will amplify the input signal without any signal distortion at the output. There are always spurious signal components, however, that are added to a signal in the form of harmonics or intermodulation distortion.

**Distortion Analysis** is used to analyze signal distortion that may not be evident using transient analysis. Signal distortion is usually the result of gain nonlinearity or phase nonuniformity in a circuit. Multisim simulates harmonic distortion and intermodulation distortion for analog small-signal circuits.

### Harmonic Distortion

A perfect linear amplifier can be described using the following formula:

$Y = AX$ , where  $Y$  is the output signal,  $X$  is the input signal and  $A$  is the amplifier gain.

The general expression including higher order terms is given by the following:

$Y = AX + BX^2 + CX^3 + DX^4 + \dots$ , where B and C, etc. are the constant coefficients for the higher order terms.

The second term in the above equation is known as the second-order component, the third term is the third-order component and so on. Harmonic distortion can be analyzed by applying a spectrally pure signal source to a circuit design. By analyzing the output signal and its harmonics the distortion can be determined. Multisim will calculate the node voltages and branch currents at the harmonic frequencies  $2f$  and  $3f$  and display the results against the input frequency  $f$  as it is swept across the user defined frequency range.

### Intermodulation Distortion

*Intermodulation distortion* occurs when two or more signals are input into an amplifier simultaneously. In this case, the interaction of the signals produces an intermodulation effect. This analysis will determine node voltages and branch currents at the intermodulation product frequencies of  $f_1 + f_2$ ,  $f_1 - f_2$  and  $2f_1 - f_2$  vs. the user defined swept frequency.

## 11.9.1 Multisim Approach

Multisim simulates both harmonic distortion and intermodulation (IM) distortion for analog small-signal circuits. For each AC Source in the circuit you set the parameters to be used with these distortion analyses. Multisim will determine the node voltages and branch currents at each point in the circuit. For harmonic distortion values are determined for the second and third harmonics. For intermodulation distortion the analysis will calculate values at frequencies  $f_1 + f_2$ ,  $f_1 - f_2$  and  $2f_1 - f_2$ .

## 11.9.2 Preparing the Circuit for Distortion Analysis

Before you perform the analysis you must decide which sources you will use. The distortion analysis parameters are set for each source independently. Follow the steps below for each AC Source that you would like to use in the distortion analysis. To perform harmonic distortion analysis use only Step 1 and 2 below. If you want to perform an intermodulation distortion analysis follow all three steps.

- To set source options for distortion analysis:
  1. Double-click on the source.
  2. In the **Value** tab choose **Distortion Frequency 1 Magnitude** and set the input amplitude and phase.

- In the **Value** tab choose **Distortion Frequency 2 Magnitude** and set the input amplitude and phase. Only use this setting if you want to perform an intermodulation distortion analysis.

**Note** The **Value** tab for this component is scrollable. Hold down the left mouse button and move the cursor up or down as desired.

## 11.9.3 Understanding the Distortion Analysis Options

- To start **Distortion Analysis**, select **Simulate/Analyses/Distortion Analysis**.

The **Analysis Parameters** and **Output** tabs will be discussed here. For information on the other tabs see “11.3.5 The Analysis Options Tab” on page 11-29 and “11.3.6 The Summary Tab” on page 11-30.

### Analysis Parameters

Before you perform the analysis, review your circuit and decide on one or more sources and one or more nodes for analysis. Next the distortion analysis parameters are set as shown in the following dialog box. You set the frequency range for the **Distortion Analysis** to sweep across, the number of points per sweep interval and the vertical scale. For harmonic distortion leave the F2/F1 ratio unselected. This option is used for intermodulation distortion only.

Enter the start frequency for the sweep.

Enter the stop frequency for the sweep.

Units for horizontal axis.

Enter number of points (for accuracy).

Units for vertical axis.

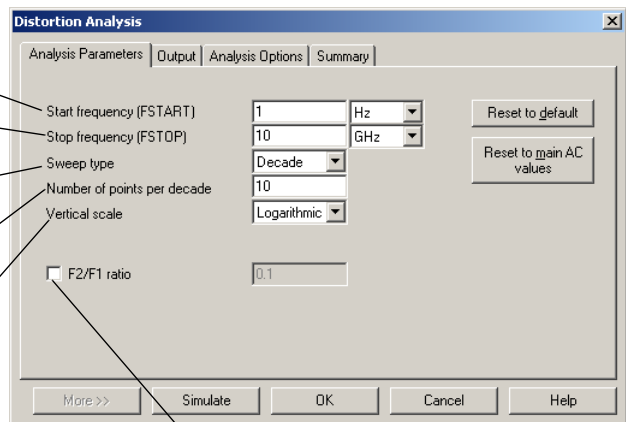

For intermodulation distortion only. When enabled, if there are signals of two frequencies (F1 and F2), then F2 is set to this ratio multiplied by the start frequency while F1 sweeps. Must be greater than 0.0 and less than 1.0.

### Output

This tab displays, on the left, all the possible output variables for the current circuit. You choose the variables you want to use in the analysis. By default, the tab displays just the most

commonly used fields. To see all the possible variables you select them by clicking the **Filter Unselected Variables** button.

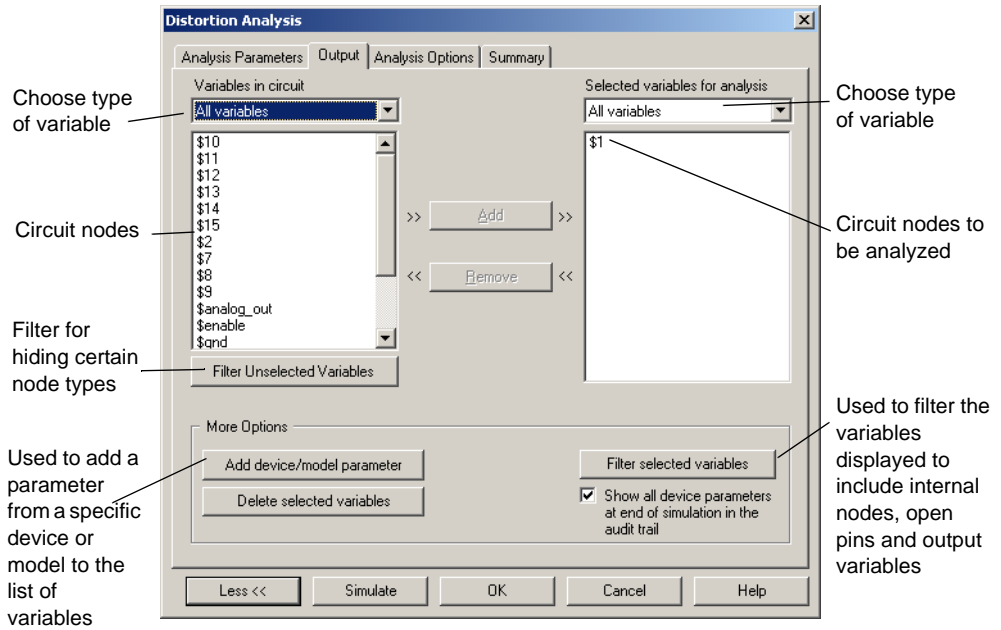

## 11.9.4 Distortion Analysis for Harmonic Distortion

To illustrate the settings and behavior of this analysis, we will use the following circuit. This is an example of a Class B Push-Pull Amplifier.

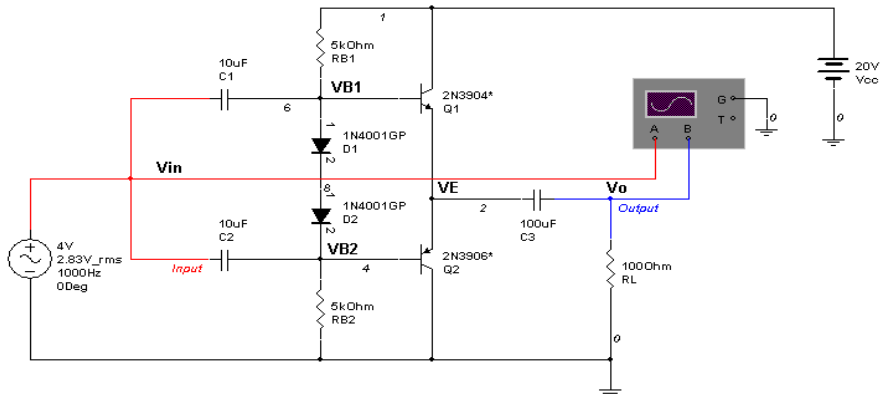

➤ To set up **Distortion Analysis** (to analyze Harmonic Distortion) follow the steps below:

1. Double-click on the AC Source and select the **Value** tab:

- Choose **Distortion Frequency 1 Magnitude** and set the input amplitude to 4 V and leave the phase at zero.
- Click **OK**.

**Note** The **Value** tab for this source is scrollable. Hold down the left mouse button and move the cursor up or down as desired.

2. Select **Simulate/Analyses/Distortion Analysis**.

3. Select the **Analysis Parameters** tab and set the following:

- Set the **Start frequency (FSTART)** to 1 Hz
- Set the **Stop frequency (FSTOP)** to 100 MHz
- Set the **Sweep type** to Decade
- Set the **Number of points per decade** to 100
- Set the **Vertical scale** to Decibel

**Note** Leave **F2/F1 ratio** unchecked.

4. Select the **Output** tab.

- Select the variable “\$output” from the list **Variables in circuit**.
- Click **Add**. The variable “output” will move to the **Selected variables for analysis** list.

5. Click **Simulate**. Two graphs will be displayed with the second harmonic distortion results on one graph and the third harmonic distortion results on the other.

**Note** To view the graph titles and axis, maximize the graph to view the following.

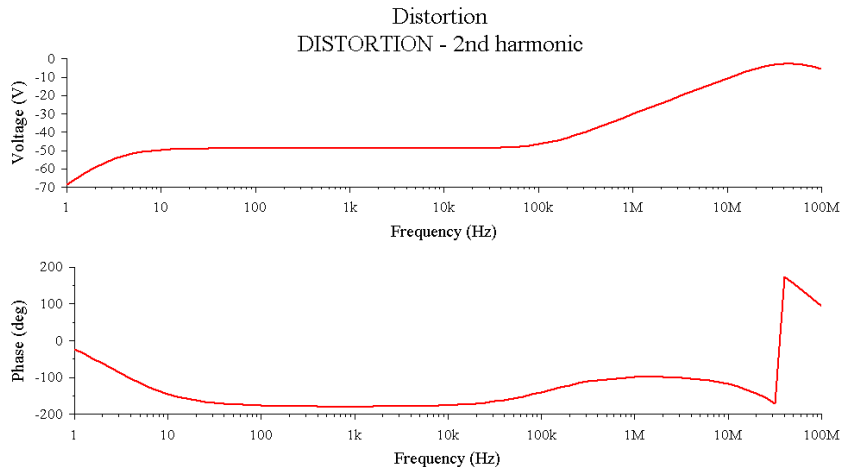

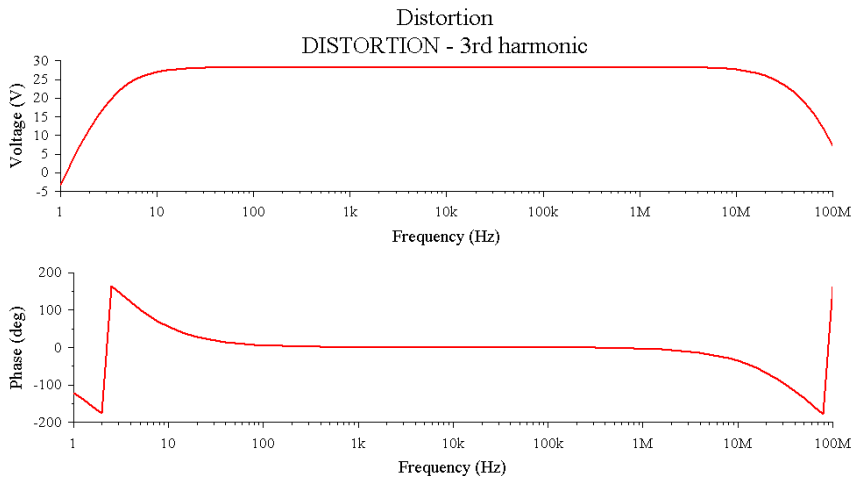

## 11.9.5 Distortion Analysis for Intermodulation Distortion

This example also uses the Class B Push-Pull Amplifier from above.

- To setup **Distortion Analysis** (to analyze Intermodulation Distortion) follow the steps below:
  1. Double-click on the AC Source and select the **Value** tab:
    - Choose **Distortion Frequency 1 Magnitude** and set the input amplitude to 4 V and leave the phase at zero.
    - Choose **Distortion Frequency 2 Magnitude** and set the input amplitude to 4 V and leave the phase at zero.
    - Click **OK**.
  - Note** The **Value** tab for this source is scrollable. Hold down the left mouse button and move the cursor up or down as desired.
  2. Select **Simulate/Analyses/Distortion Analysis**.
  3. Select the **Analysis Parameters** tab and set the following:
    - Set the **Start frequency (FSTART)** to 100 Hz.
    - Set the **Stop frequency (FSTOP)** to 10 MHz
    - Set the **Sweep type** to Decade
    - Set the **Number of points per decade** to 100
    - Set the **Vertical scale** to Decibel
    - Check the **F2/F1 ratio** and set the value to 0.499997. As F1 is swept the analysis frequency will change according to this product of the ratio and the initial value of F1 (FSTART.)



**Note** The ratio  $F2/F1$  must be greater than 0 and less than 1. Also, this number should be an irrational number but because of the finite precision of the computer this is not possible. It is best, therefore, to use a floating point number with a large number of digits.

4. Select the **Output** tab.

- Select the variable “\$output” from the list **Variables in circuit**.
- Click **Add**. The variable “output” will move to the **Selected variables for analysis** list.

5. Click **Simulate**. Three graphs will be displayed with plots for frequencies  $F1 + F2$ ,  $F1 - F2$  and  $2F1 - F2$ .

**Note**  $F2$  is the product of the ratio ( $F2/F1$  ratio) and the initial value of  $F1$  (FSTART.)

The first graph plots the  $F1+F2$  harmonic.

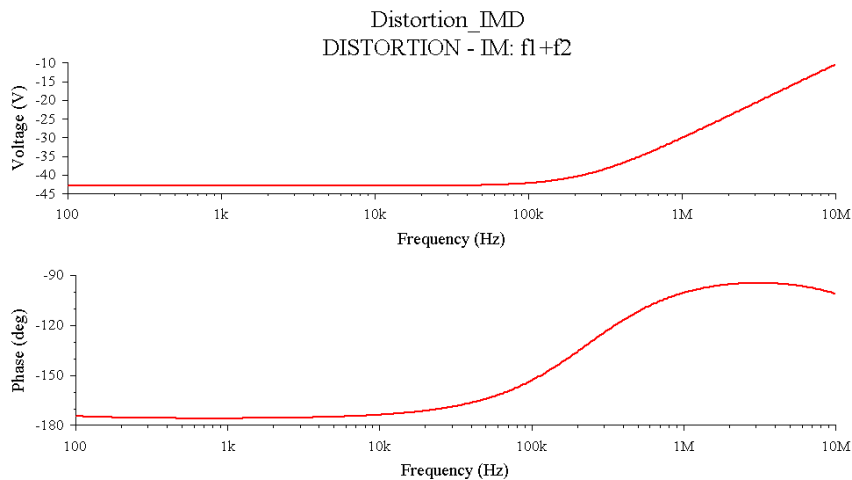

Notice as  $F1$  reaches higher frequencies (100K to 10M), if mixed with  $F2$  (50Hz), the  $F1+F2$  harmonic will increase in magnitude dramatically. At these frequencies, filtering may be needed (if possible) to separate the  $F1+F2$  harmonic from the input signal (at the circuit output).

The second graph plots the F1-F2 harmonic.

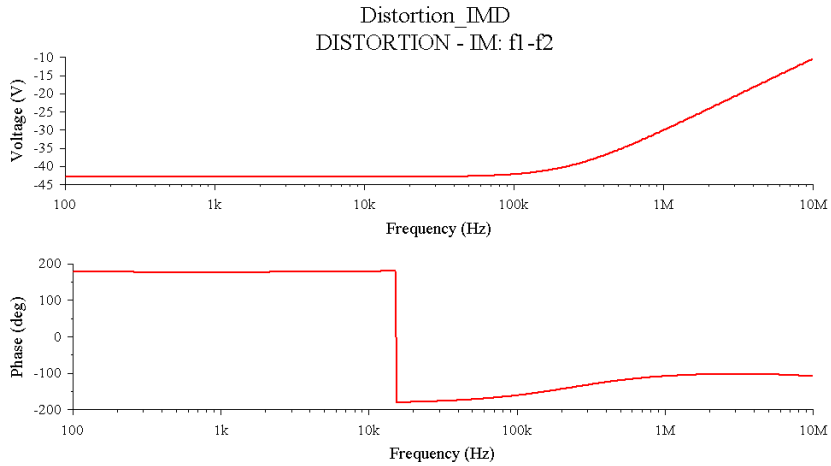

This harmonic is very similar in response to the F1+F2 harmonic. The same analysis would apply.

The third graph plots 2F1-F2 harmonic.

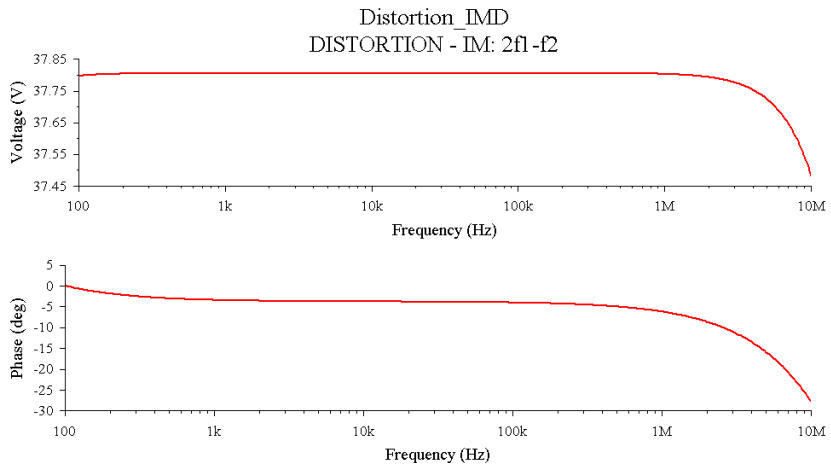

From the third graph, we notice that the 2F1-F2 harmonic is higher in magnitude than the first two harmonics (F1+F2 and F1-F2). Although the magnitude of this harmonic is low, filtering this component may be necessary.

## 11.10 DC Sweep Analysis

As this analysis is performed in Multisim, the following procedure is performed.

1. The DC Operating Point is taken.
2. The value from the source is incremented and another DC Operating Point is calculated.

This procedure allows the user to simulate the circuit many times, sweeping the DC values within a pre-determined range. The user can control the source values by choosing the start and stop values and the increment for the DC range. The bias point of the circuit is calculated for each value of the sweep. To calculate the DC response of the circuit, SPICE treats all capacitors as open circuits, all inductors as shorts, and uses only DC values of voltage and current sources.

### 11.10.1 Setting DC Sweep Analysis Parameters

Before setting analysis parameters, review your circuit and decide on one or two DC sources to sweep, and a node for analysis.

**DC Sweep Analysis** plots the appropriate curves sequentially. If only one source is being swept, a curve of the output node value versus source value is traced. If two sources are swept, the number of curves equals the number of points for the second source. Each curve represents the output node value versus the first source value while the second source value is held at each of its sweep values.

**DC Sweep Analysis** parameters are set on the following dialog box:

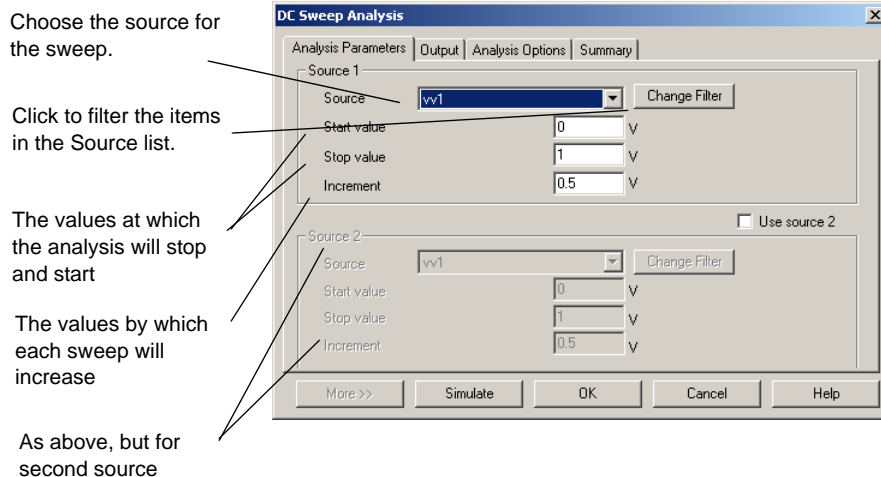

## Setting DC Sweep Analysis Parameters

For normal use, you only need to set:

- the source for the sweep, by choosing from the **Source** drop-down list under the **Source 1** options
- a starting value for the sweep, by entering it in the **Start Value** field
- a stop value for the sweep, by entering it in the **Stop Value** field
- an increment value for the sweep, by entering it in the **Increment** field.

The analysis will calculate the circuit's bias point values beginning with the specified start value. The **Increment** value will then be added to the start value and the circuit variables will be recalculated. The **Increment** value is added again and the process continues until the stop value is reached.

## Setting DC Sweep Analysis Parameters Using Filters

You can filter the variables displayed to include internal nodes (such as nodes inside a BJT model or inside a SPICE subcircuit), open pins, as well as output variables from any sub-modules contained in the circuit.

- To filter the variables displayed:
  1. Click **Change Filter**. The **Filter Nodes** dialog box appears.
  2. Enable one or more settings.
  3. Click **OK**.

For details on the other tabs in the analysis window, see “11.3 Working with Analyses” on page 11-23.

## 11.10.2 DC Sweep Analysis Examples

In this example we will vary V2 from 0 V to 20 V and observe the output at node 3.

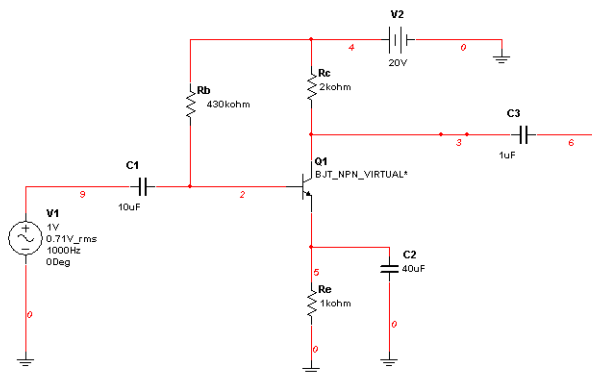

### Expected Results

$$I_b = \frac{V_{cc} - V_{be}}{R_b + (\beta + 1) * R_e} = \frac{20V - 0.7V}{430k\Omega + (51)(1k\Omega)} = \frac{19.3V}{481k\Omega} = 40.1\mu A$$

$$I_c = \beta * I_b = 50(40.1\mu A) = 2.01mA$$

$$V_c = V_{cc} - I_c R_c = 15.98V$$

Where

$I_b$  = Base Current

$\beta$  = Gain (= 50)

$V_{cc}$  = Voltage Source (V1)

$V_{be}$  = Voltage from Base to Emitter

$I_c$  = Collector current

$V_c$  = Collector Voltage

➤ To set up the analysis:

1. Select **Simulate/Analyses/DC Sweep** and click on the **Analysis Parameters** tab.
2. Enter the values shown below:

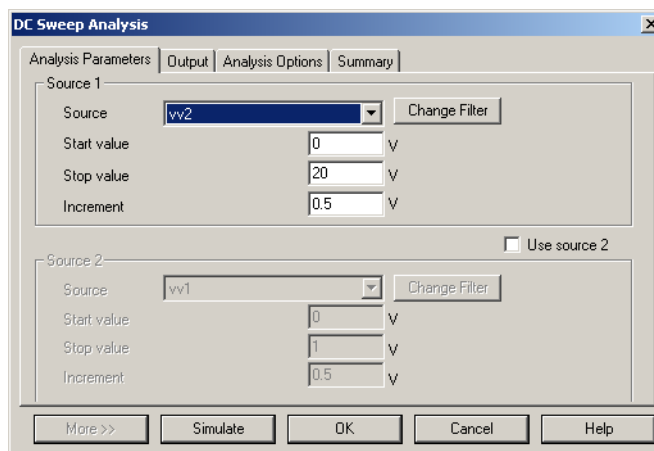

3. In the **Output** tab, enter the values below:

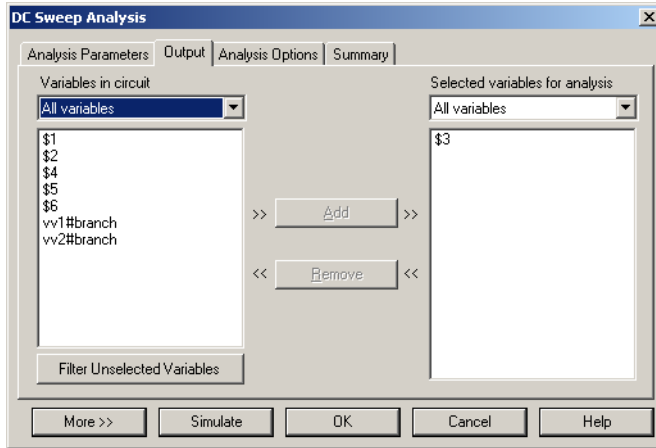

4. Click on the **Simulate** button, the graph will be displayed:

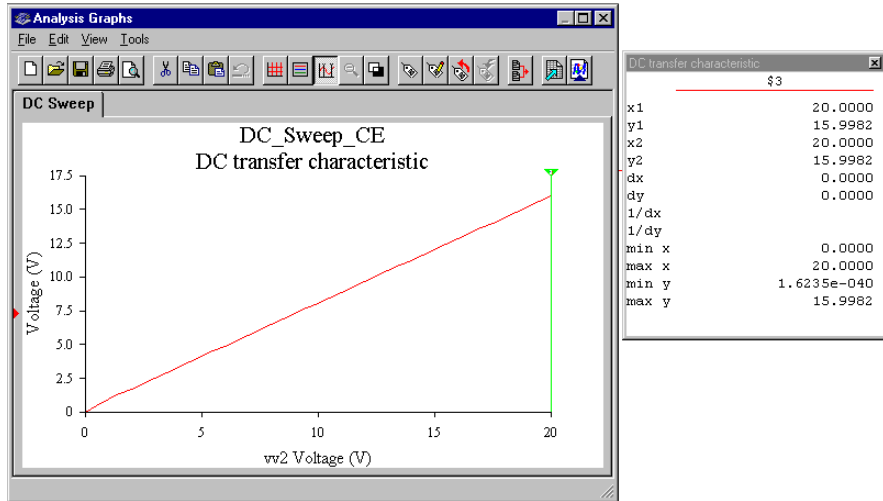

5. To view the cursors and DC transfer characteristics, select in the grapher **View/Show/Hide Cursor**. Two cursors will be displayed. Move cursor 2 to the left side of the graph, and move cursor 1 to the right and line it up along the x-axis with  $vv2 = 20$  V.

The cursor set at  $V=20$  V ( $x_1$ ), in the figure above displays the transfer characteristics for  $y_1$ , which displays the value of 15.9982 V. Therefore the graph displays when the DC source  $V_2$  is set to 20 V, then the output from the collector of the transistor will be 15.99 V.

### Example 2 (Nested DC Sweeps)

The following example displays the characteristics of the transistor in a common emitter configuration. The graph will display the operating points for this transistor, which will define the region in which amplification will occur.

The current controlled voltage source (V3) has been added so that current flow through the collector can be converted to a voltage for display on the grapher.

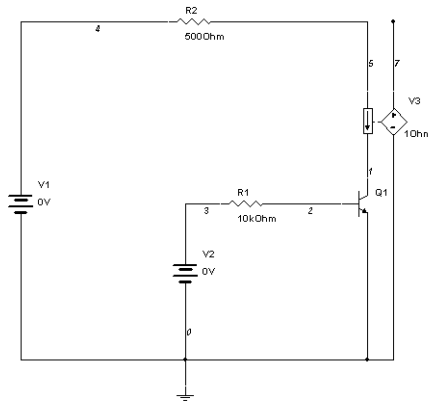

➤ To set up the analysis:

1. Enter the parameters shown below:

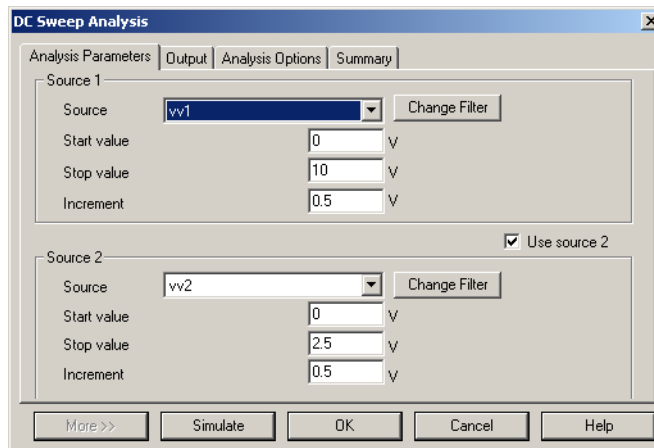

2. In the **Output** tab, enter the following:

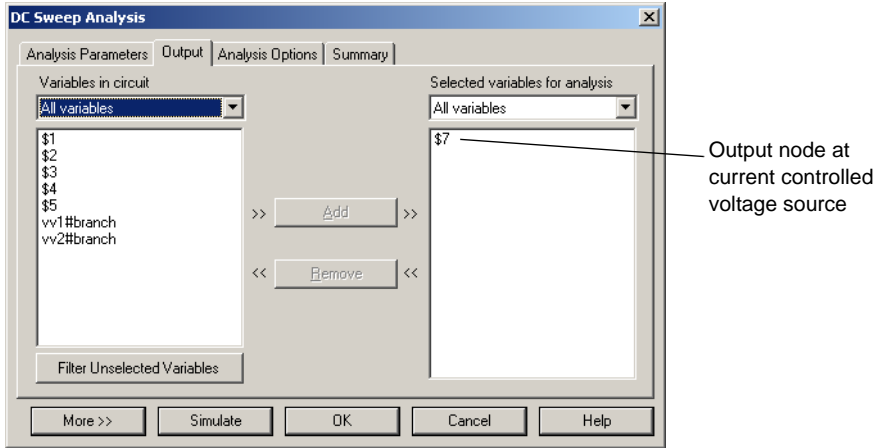

3. Click **Simulate**. The following displays in the grapher.

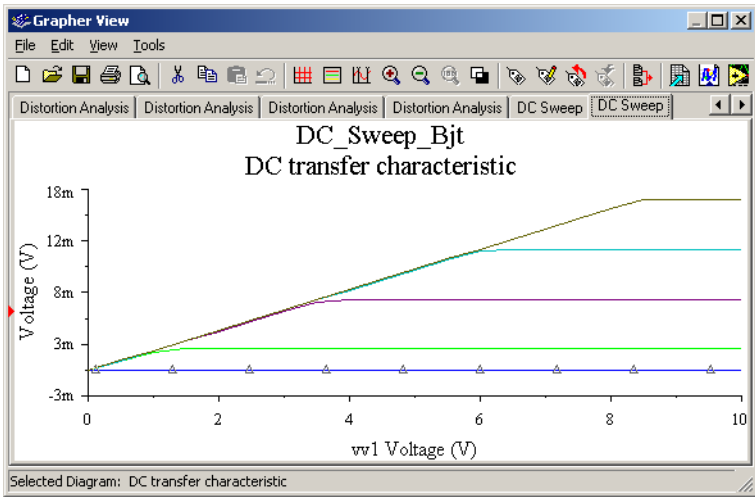



## 11.11 DC and AC Sensitivity Analyses

**Sensitivity Analyses** help identify how much a circuit component will affect the output signal. As a result, critical components can be specified with tighter tolerances, and are the best candidates for optimization. Likewise, the least critical components can be identified, which make good candidates for cost reduction as their precision does not critically affect design performance.

**Sensitivity Analysis** calculates the sensitivity of an output node voltage or current with respect to the parameters of a component(s) in your circuit. Sensitivity is expressed as the change in output per unit change of input (both in values and percentages).

### 11.11.1 Sensitivity Analysis Parameters

**Sensitivity Analysis** includes:

- DC Sensitivity
- AC Sensitivity.

Both analyses calculate the change produced in an output voltage or current by changing each parameter independently. The results of the DC sensitivity analysis are displayed in tabular form on the grapher. The AC sensitivity analysis plots the AC graphs for each parameter selected over the user defined frequency range.

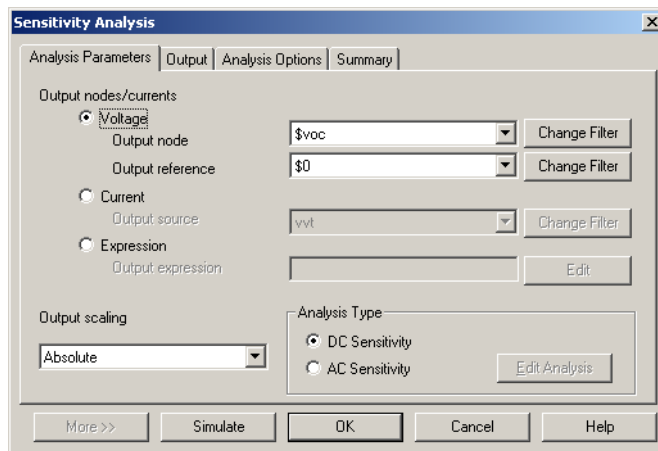

When setting up **Sensitivity Analysis**, the following options must be specified:

**Output nodes/currents:**

- **Voltage:** Sensitivity Analysis will look at node voltages.
  - **Output node** - select the node to examine
  - **Output reference** - select the reference point for the Output node. Usually this is node 0 (Ground).
- **Current:** Output current will be used to determine sensitivity.
- **Expression:** directly enter an output expression for analysis in the **Output Expression** field or click **Edit** to display the **Analysis Expression** dialog box. For details, see “11.3.4 Adding Analysis Expressions” on page 11-27.

**Output Scaling:** Select either **Absolute** or **Relative**:

- **Absolute** — the output voltage or current change per unit of change of the selected component parameter.
- **Relative** — the output voltage or current change per relative change of the selected component parameter relative to the voltage or current when the component parameter is unchanged.

**Analysis Type:**

- **DC Sensitivity** — DC sensitivity analysis generates a report of the output voltage at a circuit node with respect to all components and their parameters. You can choose to run a DC sensitivity analysis of the current source or voltage source.
- **AC Sensitivity** — AC sensitivity analysis plots an AC graph (frequency domain) for each parameter of the component.

## 11.11.2 Setting Up and Running Sensitivity Analysis

### 11.11.2.1 Example 1

We will determine the AC sensitivity of the circuit shown below to the resistance of R1 at node 2.

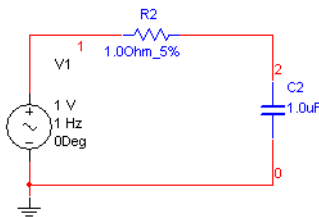

- To setup **Sensitivity Analysis**, follow the steps listed below.
1. Select **Simulate/Analyses/Sensitivity**.
  2. Select the **Analysis Parameters** tab and set the following:
    - Set **Output nodes/currents** to **Voltage**.
    - Set **Output node** to **\$2** and **Output reference** to **\$0**.
    - Set **Output scaling** to **Absolute**.
    - Set **Analysis type** to **AC Sensitivity**.
  3. Click **Edit Analysis** to display the **Sensitivity AC Analysis** dialog box and set the parameters as shown below:

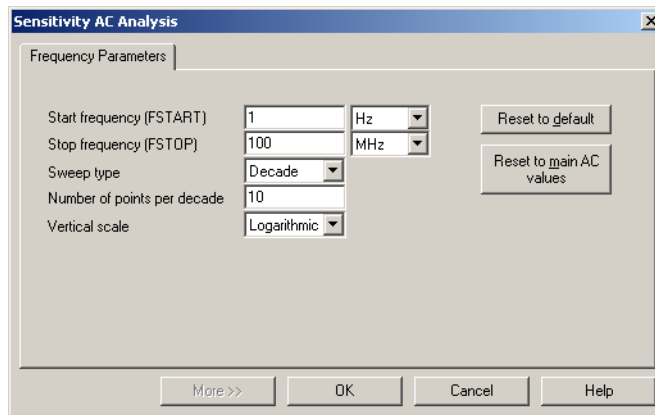

4. Select the **Output** tab:
    - Select **rr2** under **Variables in circuit**. You may need to select **Filter Unselected Variables**, select all items and choose **OK** to see the resistor in the selection area.
    - Click **Add**.
- Note** The rr2 variable will move to the **Selected variables for analysis** field.

5. Click **Simulate**. The following is displayed:

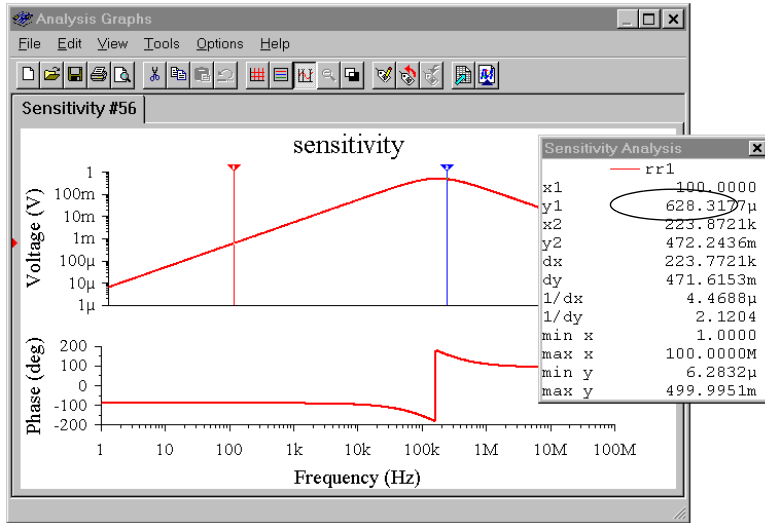

The results will plot the output voltage change if R1 is changed by 1Ω from 1Hz to 100MHz. It is possible to calculate the Sensitivity results manually. However, this can only be done for one frequency value at a time. We will analyze the same circuit at 100Hz.

Using the Sensitivity results shown above the analysis reports that at 100 Hz, the output will change by 628 uV. To calculate this value, we will follow the instructions below:

$$X_c = \frac{1}{2\pi f C}$$

$$X_c = \frac{1}{2\pi * 100 * 1 * 10^{-6}} \quad (\text{at } 100\text{Hz})$$

Therefore:

$$X_c = 1.59K$$

$$V_{out} = \frac{1v * 1\Omega}{1\Omega - j1.59K} \quad (\text{the voltage at node 2})$$

$$V_{out} \approx \frac{1}{-j1.59K}$$

$$V_{out} = 628uv$$

If R1 changes by a unit ( $R1=2\Omega$ ),

$$V_{out} = \frac{1v * 2\Omega}{2\Omega - j1.59K}$$

$$V_{out} = 1.2579mv$$

Therefore, the voltage change is 629 uV. This is supported by the results calculated by Multisim.

## 11.11.2.2 Example 2

To truly understand the power of this analysis, we will analyze the speech filter circuit shown below. When building this circuit, all components will have tolerances. Therefore, the circuit output will always change slightly from simulated results to real results. We will use **Sensitivity Analysis** to predict which component(s) will affect the circuit dramatically if their values are slightly different from expected.

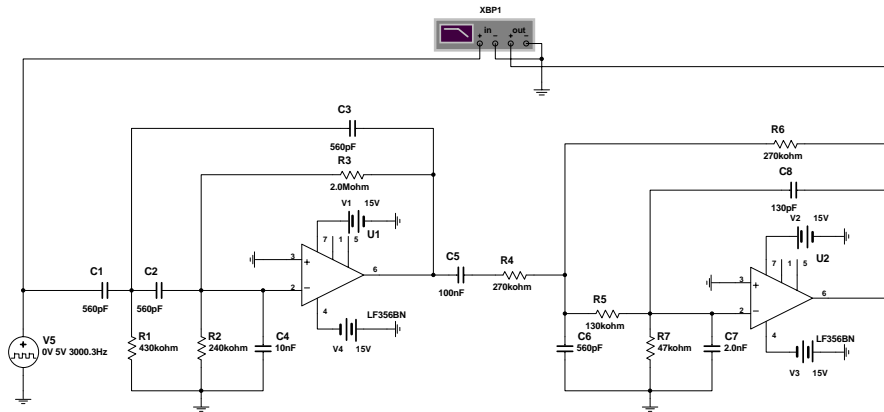

- To start **Sensitivity Analysis**:
  1. Select **Simulate/Analyses/Sensitivity**.
  2. Select the **Output** tab, set the following:
    - Select rr1 under **Variables in circuit** field.
    - Click **Add**.
    - Repeat for rr2 to rr7.
  3. Select the **Analysis Parameters** tab, set the following:
    - Set **Output Nodes/currents** to **Voltage**.
    - Set **Output node** to \$14 and **Output reference** to \$0.
    - Set **Output scaling** to Absolute.
    - Set **Analysis type** to AC Sensitivity.
  4. Click **Simulate**. The **Grapher** will plot the sensitivity for all resistors in the design.

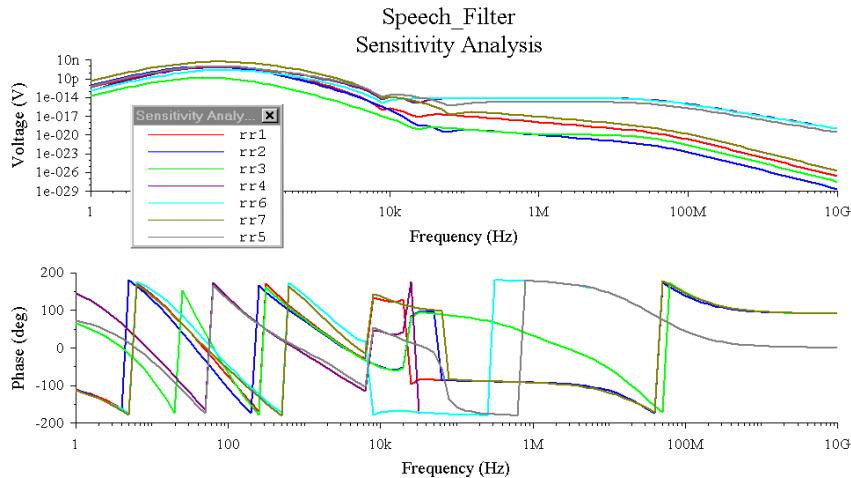

From the graph, we can determine that if any resistor is changed by 1 ohm, the results will not change dramatically. However, R7 will cause the biggest change in the circuit output.

## 11.12 Parameter Sweep Analysis

### 11.12.1 About the Parameter Sweep Analysis

With **Parameter Sweep Analysis**, you can verify the operation of a circuit by simulation across a range of values for a component parameter. The effect is the same as simulating this circuit several times, once for each value. You control the parameter values by choosing a start value, end value, type of sweep that you wish to simulate and the desired increment value in the **Parameter Sweep** dialog box. There are three types of analysis that can be performed on the circuit while the component is manipulated: **DC Operating Point**, **Transient Analysis** and **AC Analysis**.

You will find that some components have more parameters that can be varied than others. This will depend on the model of the component. Active components such as opamps, transistors, diodes and others will have more parameters available to perform a sweep than passive component such as resistors, inductors and capacitors. For example the inductance is the only parameter available for an inductor as compared to a diode model that contains approximately 15 to 25 parameters.

## 11.12.2 Setting Parameter Sweep Analysis Parameters

The behavior of a circuit is affected when certain parameters in specific components change. Before you perform the analysis, review your circuit and decide on a component and parameter to sweep, and a node for analysis.

**Parameter Sweep Analysis** parameters are set in the following dialog box:

**Note** If your dialog box does not look like the example below, click **More** to display the full analysis dialog box.

The screenshot shows the **Parameter Sweep** dialog box with the following fields and options:

- Sweep Parameters:**
  - Sweep Parameter:** A dropdown menu currently set to **Device Parameter**.
  - Device:** A dropdown menu set to **BJT**.
  - Name:** A text field containing **q2.xu3.og**.
  - Parameter:** A dropdown menu set to **off**.
  - Present:** A text field containing **0**.
  - Description:** A text field containing **Device initially off**.
- Points to sweep:**
  - Sweep Variation Type:** A dropdown menu set to **List**.
  - Value List:** An empty list box with scroll arrows.
- More Options:**
  - Analysis to sweep:** A dropdown menu set to **Transient Analysis**.
  - Edit Analysis:** A button to the right of the dropdown.
  - Group all traces on one plot:** A checked checkbox.

Annotations provide the following instructions:

- Choose sweep parameter: Device Parameter or Model Parameter.** (points to Sweep Parameter dropdown)
- Dictates how to calculate the interval between the stop and start values. Choose from Decade, Octave, Linear, or List.** (points to Sweep Variation Type dropdown)
- For List sweep only. A list of values to sweep over. Items in the list must be separated by spaces, commas or semicolons.** (points to Value List)
- Choose DC Operating Point, AC Analysis, Transient Analysis, Nested Sweep.** (points to Analysis to sweep dropdown)
- Click to edit parameters of the chosen analysis. For Nested Sweep analysis, see "11.20 Nested Sweep Analyses" on page 11-121.** (points to Edit Analysis button)
- If not enabled, each trace appears on a separate plot.** (points to Group all traces on one plot checkbox)
- Choose the type of device to sweep: i.e. BJT, Capacitor or Inductor.** (points to Device dropdown)
- Enter the component to sweep.** (points to Name text field)
- Choose the device parameter of the component to be swept.** (points to Parameter dropdown)



Parameter sweep analysis plots the appropriate curves sequentially. The number of curves is dependent on the type of sweep as shown below:

Type of Sweep	Curves
Linear	The number of curves is equal to the difference between the start and end values divided by the increment step size.
Decade	The number of curves is equal to the number of times the start value can be multiplied by ten before reaching the end value.
Octave	The number of curves is equal to the number of times the start value can be doubled before reaching the end value.

## Setting Parameter Sweep Analysis Parameters

➤ To set up the analysis parameters:

1. Select a sweep parameter by choosing a parameter type (Device or Model) from the **Sweep Parameter** drop-down list, then enter information in the **Device**, **Name**, and **Parameter** fields.  
A brief description of the parameter appears in the **Description** field and the present value of the parameter is displayed in the **Present Value** field.
2. Set the sweep variation type by choosing either linear, decade, or octave from the **Sweep Variation Type** drop-down list.
3. Select the analysis to sweep by choosing from the **Analysis to sweep** drop-down list.
4. If you want to sweep other than the list, type the desired parameter values, separated by a space, in the **Values** field.
5. Optionally, you can set the analysis parameters by clicking **Edit Analysis**. The analysis parameters available depend upon the analysis selected. See the respective analysis elsewhere in this chapter for details on setting these parameters.

**Note** If the analysis is unedited, the last values set for the analysis will be used. If the analysis has not been run previously, the default values will apply.

**Note** You can also perform nested sweeps, combining various levels of device/model parameter sweeps (see “11.20 Nested Sweep Analyses” on page 11-121).



If  $L_0 = 500\mu\text{H}$ , then the frequency at the output of the circuit will be:

$$f_r = \frac{1}{2\pi\sqrt{(500\mu\text{H})(41\text{pf})}} = 1.1\text{MHz}$$

If  $L_0 = 900\mu\text{H}$ , then the frequency at the output of the circuit will be:

$$f_r = \frac{1}{2\pi\sqrt{(900\mu\text{H})(41\text{pf})}} = 828\text{KHz}$$

➤ To setup and run the analysis:

1. Select **Simulate/Analyses/Parameter Sweep**.
2. Select the **Analysis Parameters** tab and enter the parameters as below.

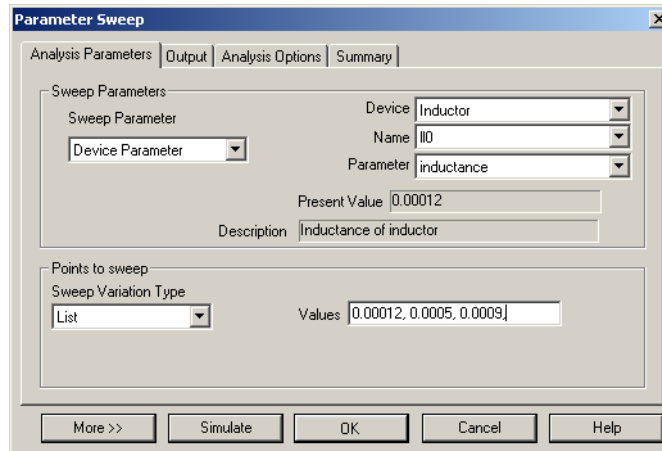

3. Click **More** and set the following:

- **Analysis to Sweep** drop-down—select Transient Analysis.
- **Group all Traces on one Plot** checkbox—enabled.

- Click **Edit Analysis** and set the values as follows.

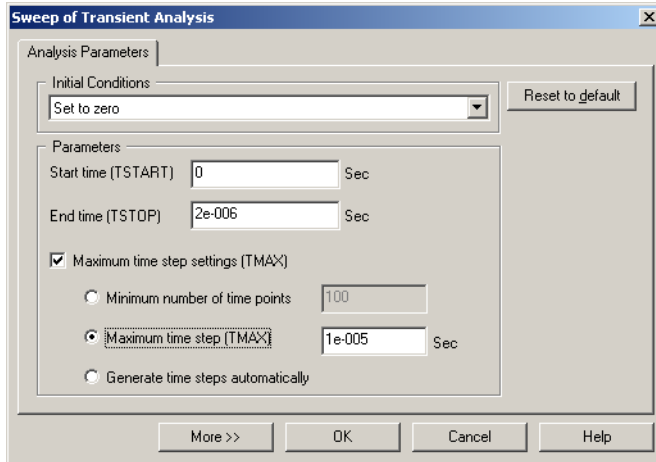

- Select **OK**.
- Select the **Output** tab.
- For this circuit the output variable is at node 3. Under **Variables in circuit** highlight variable 3 and click on **Add**. Once selected you will notice that variable is under the column **Selected variable for analysis**.

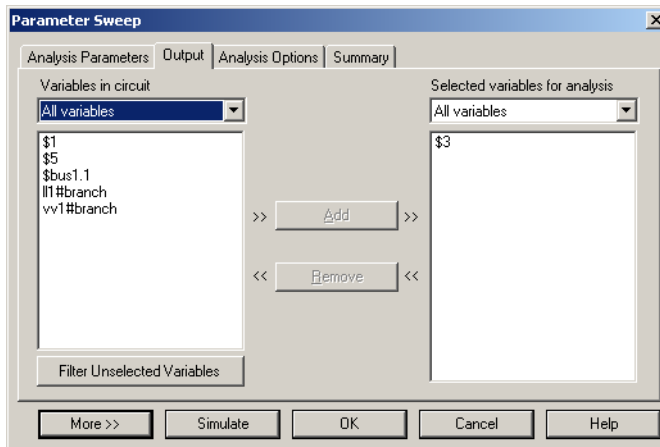

8. Click **Simulate** to generate the results.

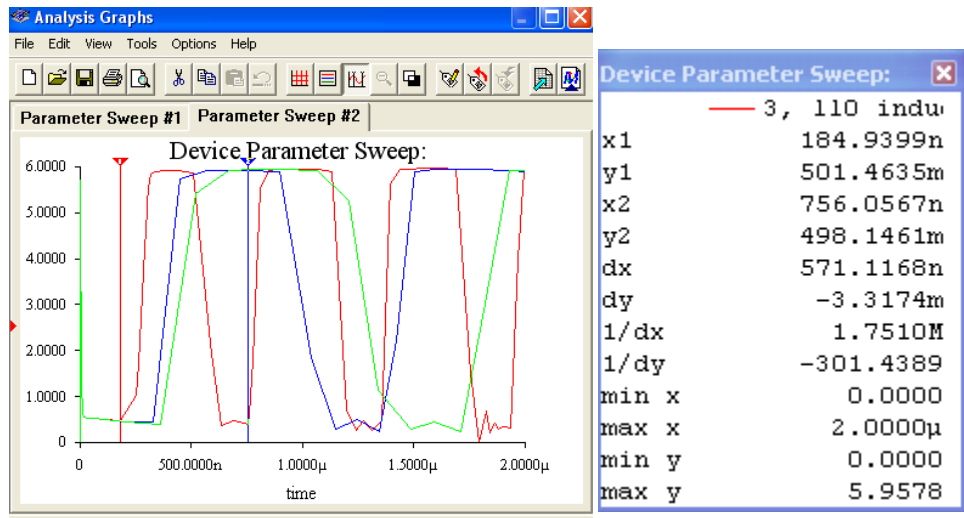

➤ To view the results:

1. In the graph window select **View/Show/Hide Cursors**.
2. To verify the frequency of the signal when  $L_0 = 120\mu\text{H}$ , move cursor 1 to the first rising edge of the signal and cursor 2 to the next rising edge as shown in the above graph. To verify the results use the values of X1 and X2 in the **Device Parameter Sweep** table.

$$Time(\text{sec } s) = X_2 - X_1 = 756.05\text{n} - 184.93\text{n} = 571.12\text{ns}$$

$$fr = \frac{1}{Time} = 1.75\text{MHz}$$

- To verify the frequency of  $L_0 = 500\mu\text{H}$ , move cursor 1 to the rising edge of the next signal and cursor 2 to the next rising edge shown below.

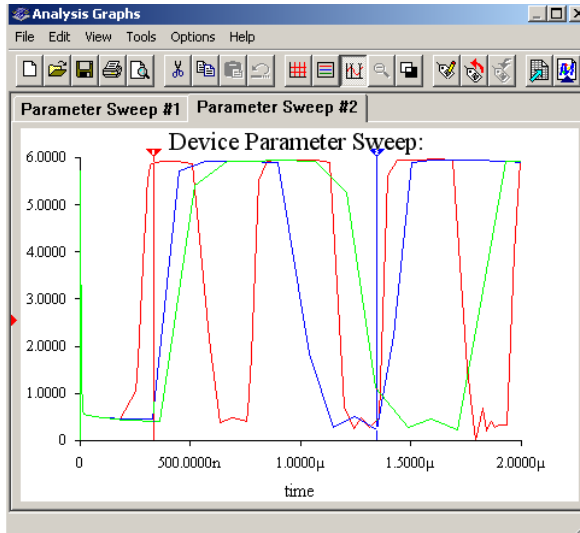

Device Parameter Sweep:	
	— 3, 110 indu
x1	333.5349n
y1	5.8776
x2	1.3465μ
y2	428.1902m
dx	1.0129μ
dy	-5.4494
1/dx	987.2389k
1/dy	-183.5060m
min x	0.0000
max x	2.0000μ
min y	0.0000
max y	5.9578

$$Time(sec\ s) = X_2 - X_1 = 1.3465\mu - 333.53n = 1.012\mu s$$

$$fr = \frac{1}{Time} = 987.196\text{KHz}$$

4. To verify  $L_o = 900\mu\text{H}$  move cursor 1 to the rising edge of the next signal and cursor 2 to the next rising edge shown below.

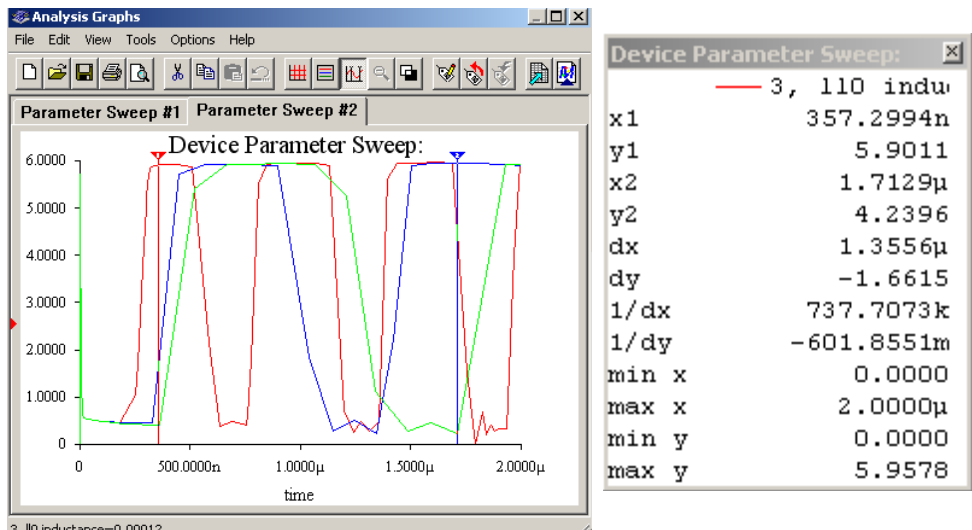

$$Time(\text{sec } s) = X2 - X1 = 1.7129\mu - 357.299n = 1.355\mu s$$

$$fr = \frac{1}{Time} = 737.680\text{KHz}$$

The simulated results are similar to the expected results.

## 11.13 Temperature Sweep Analysis

### 11.13.1 About the Temperature Sweep Analysis

Using **Temperature Sweep Analysis**, you can quickly verify the operation of your circuit by simulating it at different temperatures. The effect is the same as simulating the circuit several times, once for each temperature. You control the temperature values by choosing start, stop and increment values.

You may perform three types of sweeps: **DC Operating Point**, **Transient Analysis**, and **AC Frequency Analysis**.

**Assumptions** See the assumptions for the selected analysis: DC operating point analysis described in “11.4 DC Operating Point Analysis” on page 11-31, transient analysis described in “11.6 Transient Analysis” on page 11-38, or AC frequency analysis described in “11.4 DC Operating Point Analysis” on page 11-31.

Temperature sweep analysis affects only components whose model includes temperature dependency, including:

- Virtual Resistor
- 3 - Terminal Depletion N-MOSFET
- 3 - Terminal Depletion P- MOSFET
- 3 - Terminal Enhancement N- MOSFET
- 3 - Terminal Enhancement P- MOSFET
- 4 - Terminal Depletion N- MOSFET
- 4 - Terminal Depletion P- MOSFET
- 4 - Terminal Enhancement N- MOSFET
- 4 - Terminal Enhancement P- MOSFET
- Diode
- LED
- N-Channel JFET
- NPN Transistor
- P-Channel JFET
- PNP Transistor



## 11.13.2 Setting Temperature Sweep Analysis Parameters

Before you perform the analysis, review your circuit and decide on a node for analysis.

**Temperature Sweep Analysis** parameters are set in the following dialog box:

**Note** If your dialog box does not look like the example below, click **More** to display the full analysis dialog box.

The screenshot shows the 'Temperature Sweep Analysis' dialog box with the following components and annotations:

- Analysis Parameters** tab is selected.
- Sweep Parameters** section:
  - Sweep Parameter**: A dropdown menu set to 'Temperature'.
  - Present**: A text field containing '27 °C'.
  - Description**: A text field containing 'Temperature sweep of the circuit.'
- Points to sweep** section:
  - Sweep Variation Type**: A dropdown menu set to 'List'.
  - Value List**: An empty list box with a '°C' unit indicator.
- More Options** section:
  - Analysis to sweep**: A dropdown menu set to 'Transient Analysis'.
  - Group all traces on one plot**: A checked checkbox.
  - Edit Analysis**: A button.
- Buttons** at the bottom: 'Less <<', 'Simulate', 'OK', 'Cancel', and 'Help'.

Annotations with arrows pointing to specific elements:

- 'Displays the parameter type: Temperature' points to the 'Sweep Parameter' dropdown.
- 'Dictates how to calculate the interval between the stop and start values. Choose from Decade, Octave, Linear, or List.' points to the 'Sweep Variation Type' dropdown.
- 'For List sweep only. A list of values to sweep over. Items in the list must be separated by spaces, commas or semicolons.' points to the 'Value List' box.
- 'If not enabled, each trace appears on a separate plot.' points to the 'Group all traces on one plot' checkbox.
- 'Choose DC Operating Point, AC Analysis, Transient Analysis.' points to the 'Analysis to sweep' dropdown.
- 'Click to edit parameters of the chosen analysis.' points to the 'Edit Analysis' button.

Temperature sweep analysis plots the appropriate curves sequentially. The number of curves is dependent on the type of sweep, as shown below.

Type of Sweep	Curves
Linear	The number of curves is equal to the difference between the start and end values divided by the increment step size.
Decade	The number of curves is equal to the number of times the start value can be multiplied by ten before reaching the end value.
Octave	The number of curves is equal to the number of times the start value can be doubled before reaching the end value.

### Setting Temperature Sweep Analysis Parameters

You can use the **Analysis Parameters** tab to define the temperature values to be swept, and the type of analysis to be run at the various swept temperatures. You can also edit the specific analysis being performed.

- To set up and run temperature sweep:
  1. Choose the type of distribution (linear, decade, or octave) from the **Sweep Variation Type** drop-down list. To enter a list of temperatures, enter each value separated by a space.
  2. Choose the analysis to be performed from the **Analysis to sweep** drop-down list.
  3. Click **Edit Analysis** to specify the analysis parameters. The analysis parameters available depend on the analysis selected. See the respective analysis elsewhere in this chapter for details on setting these parameters. If the analysis is unedited, the last values set for the analysis will be used. If the analysis has not been run previously, the default values will apply.
  4. Select the **Output** tab and choose the node for which you want to see the results.
  5. Click **Simulate** to generate the results.

## 11.14 Transfer Function Analysis

### 11.14.1 About the Transfer Function Analysis

**Transfer Function Analysis** calculates the DC small-signal transfer function between an input source and two output nodes (for voltage) or an output variable (for current) in a circuit. It also calculates input and output resistances. Any nonlinear models are first linearized based on the DC operating point and then small-signal analysis is performed. The output variable can be any node voltage, while the input must be an independent source defined somewhere in the circuit.

**Assumptions** Analog circuit, linear models. Models are linearized.

The DC small signal gain is the derivative of the output with respect to the input at the DC bias-point (and zero frequency). For example:

$$\frac{dV_{OUT}}{dV_{IN}}$$

The input and output resistance of a circuit refers to the “dynamic” or small-signal resistance at the input or output. Mathematically, small-signal DC resistance is the derivative of the input voltage with respect to the input current at the DC bias-point (and zero frequency). The following is an expression for input resistance:

$$\frac{dV_{IN}}{dI_{IN}}$$

In Multisim, the results of the **Transfer Function Analysis** produces a chart showing the ratio of the output to the input signal, the input resistance at the input source node and the output resistance across the output voltage nodes.

**Note** This is a DC analysis and does not calculate either the time- or frequency-domain transfer function.

## 11.14.2 Setting Transfer Function Analysis Parameters

Before you perform the analysis, review your circuit and decide on an output node, a reference node and an input source.

Transfer Function Analysis parameters are set in the following dialog box:

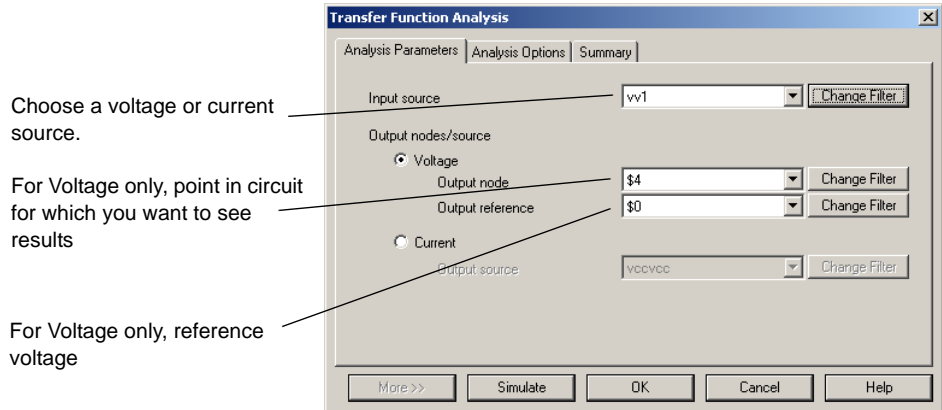

Transfer function analysis produces a chart showing the transfer function (output/input), input resistance at the input source and output resistance across the output voltage nodes or at the output variable.

### Setting Transfer Function Analysis Parameters

- To set up and run **Transfer Function Analysis**:
  1. Choose an input source from the **Input source** drop-down list
  2. Enable **Voltage** and select an output node from the **Output node** drop-down list and an output reference node (usually ground or node 0) from the **Output reference** drop-down list

*Or*

Enable **Current** and select a current from the **Output source** drop-down list.

**Note** A source current or output node voltage can be used for this analysis.

You can filter the variables displayed to include internal nodes (such as nodes inside a BJT model or inside a SPICE subcircuit), open pins, as well as output variables from any submodules contained in the circuit. Filtering the variables shortens the list of results.

➤ To filter the variables displayed:

1. Click **Change Filter**. The **Filter Nodes** dialog box appears:

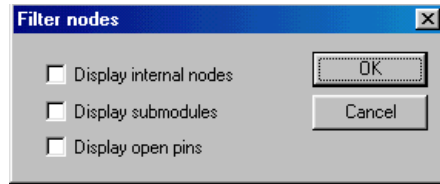

2. Enable one or more settings.

3. Click **OK**.

For details on the other tabs in the analysis window, see “11.3 Working with Analyses” on page 11-23.

## 11.14.3 Examples of Transfer Function Analysis

### 11.14.3.1 Linear Example

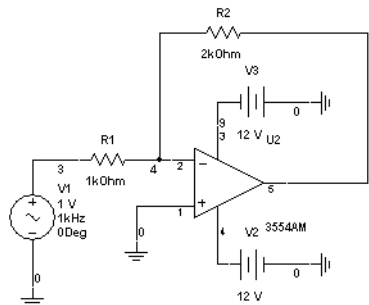

The circuit above is an inverting amplifier. The gain of this circuit is 2. We can define the mathematical function for this circuit as:

$$V_{out} = -2V_{in}$$

Taking the derivative of the equation above, we get:

$$\text{Transfer function} = \frac{\partial V_{out}}{\partial V_{in}} = -2$$

### Finding $R_{in}$

$$\therefore I_{in} \approx \frac{V_{in}}{R_1}$$

Rearranging the equation we get:

$$R_{in} = R_1 = \frac{V_{in}}{I_{in}}$$

### Finding $R_{out}$

Since the  $Z_{in}$  is much smaller than the op-amp impedance,  $Z_{out} \sim 0$ .

### Verifying the results with Multisim

- To verify the results:
  1. Set up the analysis as shown below:

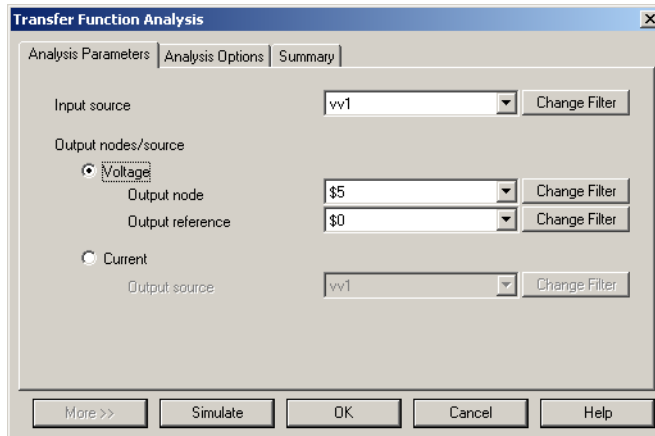

2. Click **Simulate**. Note that the transfer function result shown below closely matches the calculated value.

Transfer Function

Transfer Function Analysis		
1	Transfer function	-1.99994
2	vv1#Input impedance	1.00002 k
3	Output impedance at V(\$5,\$0)	599.98402 u

### 11.14.3.2 Non-linear Example

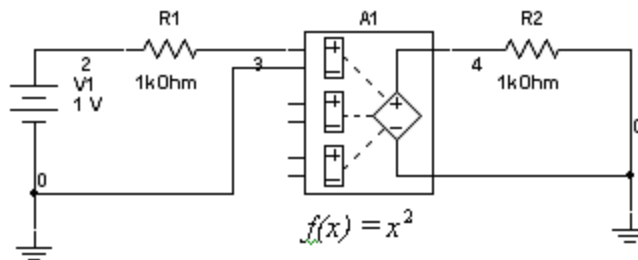

This example uses the polynomial source (A1) to square the input voltage. Double-click on A1 and enter “1” for the value of the coefficient of E as shown below. All other fields should be 0.

Coefficient of...	Value
A (Independent)	0
B (V1)	0
C (V2)	0
D (V3)	0
E (V1*V1)	1
F (V1*V2)	0

- To run the analysis:
  1. Set up the analysis as shown:

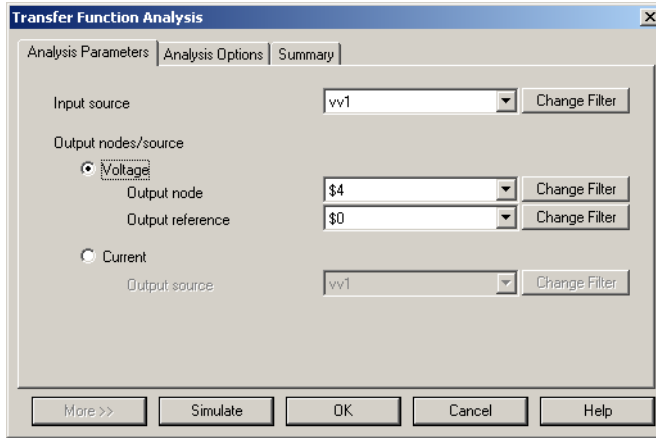

2. Click **Simulate** to run the simulation.

**Transfer Function**

Transfer Function Analysis		
1	Transfer function	2.00000
2	vv1#Input impedance	499.50052 G
3	Output impedance at V(\$4,\$0)	0.00000

**Verifying the Results**

The equation for the circuit is:

$$V_{out} = V_{in}^2$$

Therefore:

$$\text{Transfer function} = \frac{\partial V_{out}}{\partial V_{in}}$$

$$= 2V_{in}$$

$$= 2(1)$$

$$= 2$$



Note that this value matches the value in the chart that was produced during the simulation.

## 11.15 Worst Case Analysis

### 11.15.1 About the Worst Case Analysis

**Worst Case Analysis** is an analysis that lets you explore the worst possible effects of variations in component parameters on the performance of a circuit. Multisim performs the **Worst Case Analysis** in conjunction with a DC or AC analysis. In either case the simulation is first performed with nominal values. Next, a Sensitivity analysis (either AC or DC) is performed to determine the sensitivity of the specified components on the output voltage or current. Lastly, the simulation is performed with the component parameter values that will produce worst case values at the output. The worst case parameters are determined by adding or subtracting the tolerance value from the nominal value according to whether the component's sensitivity on the output is a positive or negative value.

**Assumptions** Applied to an analog circuit, DC and small-signal.  
Models are linearized.

#### **Worst Case Analysis – DC Analysis:**

Upon selecting DC analysis the following calculations are performed:

1. DC sensitivity. If the DC sensitivity of the output voltage with respect to a specific component is determined to be a negative number, then the minimum value of this component is calculated. For example, if the DC sensitivity of resistor R1 is  $-1.23 \text{ V/Ohm}$ , then the minimum value is derived from the following formula:

$$R1_{\min} = (1 - \text{Tolerance}) \times R1_{\text{nom}}$$

where,

$R1_{\min}$  = the minimum value of the resistor R1

Tolerance = Tolerance specified by the user. (Tolerance is either an absolute value, or a percentage of the nominal value).

$R1_{\text{nom}}$  = Nominal value of the resistor R1

If the DC sensitivity of the output voltage with respect to a specific component is determined to be a positive number, then the maximum value of this component is calculated. For example, a resistor with a positive sensitivity would be determined according to the formula:

$$R2_{\max} = (1 - \text{Tolerance}) \times R2_{\text{nom}},$$

where,

$R2_{\max}$  = the maximum value of the resistor R2

Tolerance = Tolerance specified by the user, expressed as a fraction of 1

$R2_{\text{nom}}$  = Nominal value of the resistor R2

2. The DC analysis is performed using the nominal value and either the minimum or maximum value of the resistance according to the sign of sensitivity analysis.

### **Worst Case Analysis – AC Analysis**

Upon selecting AC analysis the following calculations are performed:

1. AC sensitivity to determine the sensitivity of the components on the output voltage.
2. According to the sensitivity results the minimum or maximum values of the selected components are calculated as explained above.
3. AC analysis is performed using the above calculated values for the components.

#### **11.15.1.1 Setting Tolerance Parameters**

Before you perform the analysis, review your circuit and decide on an output node.

In the **Model tolerance list** tab, choose which tolerance parameters are to be used. You can do this using any of the following methods:

- To edit a tolerance in the list, select it and click **Edit selected tolerance**. The tolerance's current variable settings appear. Modify the variables as desired and click **OK** to save.
- To delete a tolerance from the list, select it and click **Delete tolerance entry**.
- To add a tolerance, click **Add a new tolerance**.

The **Tolerance** dialog box appears:

Choose type of sweep to be performed: Model Parameter or Device Parameter.

When selected, the current value and a description of the parameter appear.

Choose Absolute to enter a value, or Percent to vary the parameter by the specified percentage of its stated value.

Enter a percentage value, or a set value depending on the tolerance type selected.

The screenshot shows the 'Tolerance' dialog box with the following settings:

- Parameter Type: Model Parameter
- Device Type: BJT
- Name: qideal:xu3.og
- Parameter: npn
- Description: NPN type device
- Tolerance Type: Percent
- Tolerance value: 0

Enter the desired variables in the appropriate fields.

## 11.15.2 Setting Worst Case Analysis Parameters

Worst Case Analysis parameters are set in the following dialog box:

Choose DC Operating Point or AC Analysis. For details on either parameter, see “11.4 DC Operating Point Analysis” on page 11-31.

Choose an output variable.

Choose a function: MAX, MIN, RISE\_EDGE, FALL\_EDGE, FREQUENCY.

Click to group all traces on a single plot.

Choose a direction: Low or High.

Click to edit selected analysis.

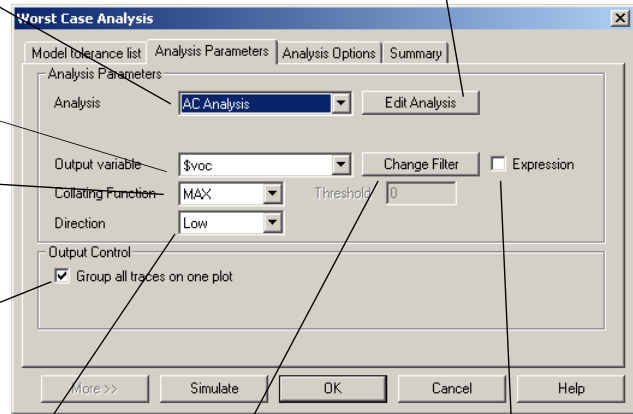

Click to change the filter that affects the list of possible output variables.

Enable to enter an analysis expression in the Output Variable field.

For DC circuits, the worst case analysis generates a table of the circuit’s possible output voltages ranging from the nominal specification value to the worst case value. A list of the components and their worst case values appears in tabular form.

For AC circuits, the worst case analysis generates separate plots for the nominal and worst case runs. A list of the components and their worst case values appears in tabular form.

*Analysis Expressions* - As well as being able to select a node in the **Output Variable** field, you can click on the **Expression** checkbox and enter an analysis expression in the **Output Variable** field. When the **Expression** checkbox is enabled, the **Change Filter** button changes to the **Edit Expression** button. You can click this to view the **Analysis Expression** dialog box where you can enter and edit expressions. For details, see “11.3.4 Adding Analysis Expressions” on page 11-27.

### 11.15.3 Worst Case Analysis Example

This circuit is a Wien-bridge oscillator. The feedback to the non-inverting pin is designed to stabilize the amplitude of the oscillator. R1 – R4 must be chosen carefully to ensure this circuit will oscillate.

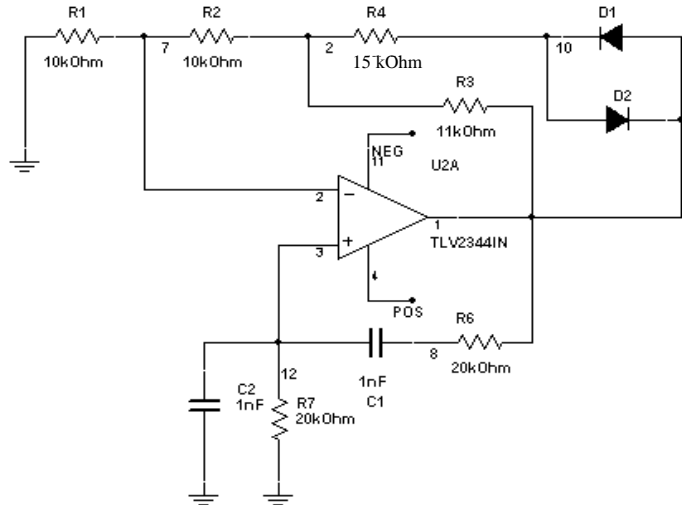

This circuit will oscillate if the following conditions are met:

$$\frac{R_2 + R_3}{R_1} > 2 \text{ and } \frac{R_2 + R_3 // R_4}{R_1} < 2$$

Under normal conditions, the output is shown below using the Oscilloscope:

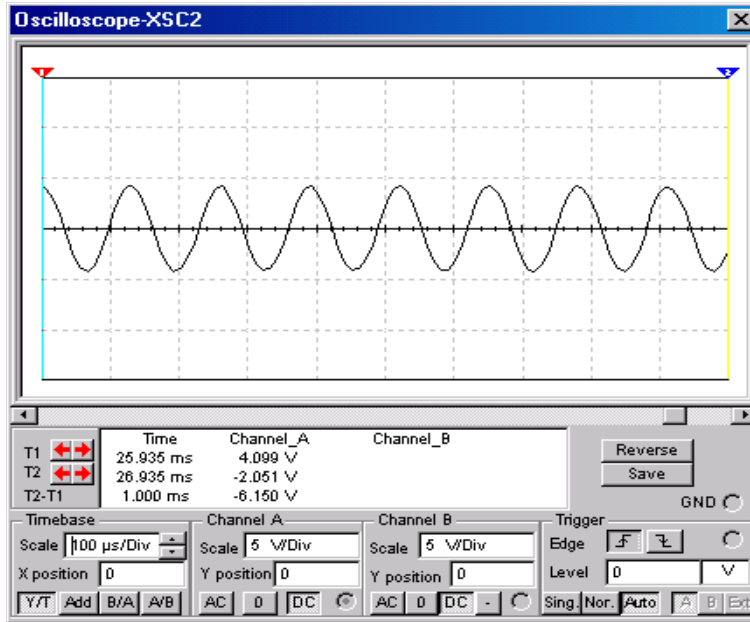

- To set up the analysis:
  1. Open the **Worst Case Analysis** dialog box and click on **Add a new tolerance**.
  2. Enter the parameters as displayed below.

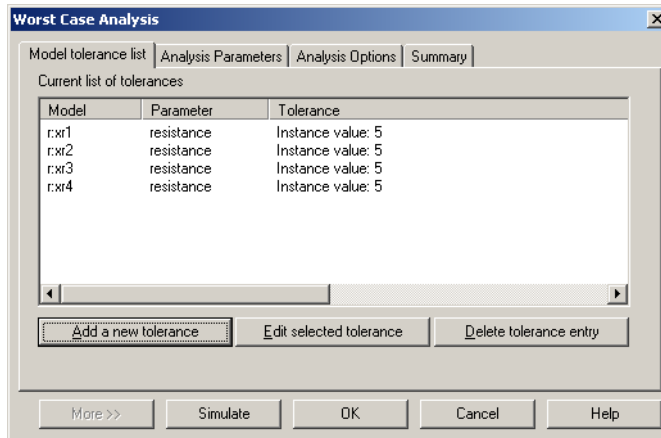

3. Click on the **Analysis Parameters** tab and confirm the following settings.

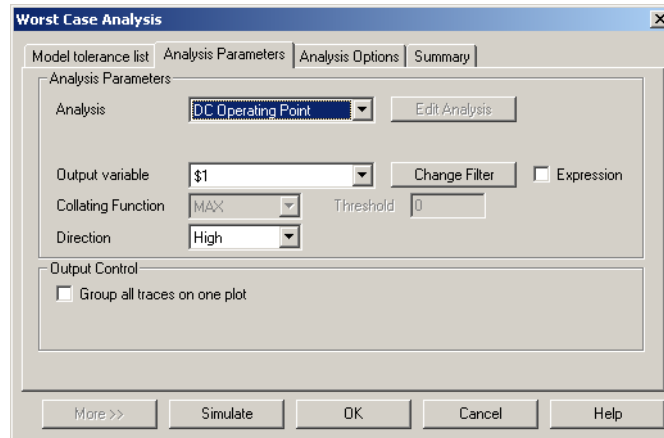

4. Click **Simulate**. The following results display.

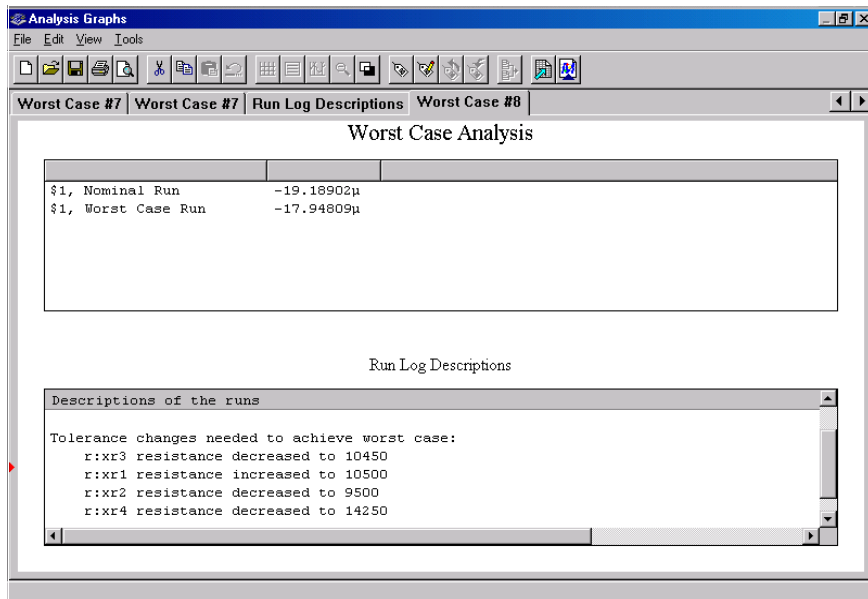

The **Worst Case Analysis** section shows the DC operating point at node 1 for both nominal and worst case.

The **Run Log Descriptions** section displays the resistance values required to achieve the greatest difference from the nominal value.

Recall that one condition for oscillation is:

$$\frac{R_2 + R_3}{R_1} > 2$$

Inserting the output results, we get:

$$\frac{9.5 + 10.45}{10.5} = 1.9$$

This does not meet the oscillation requirement. Therefore the circuit may fail if the component tolerances are not carefully chosen.

## 11.16 Pole Zero Analysis

### 11.16.1 About the Pole Zero Analysis

**Pole Zero Analysis** is used to determine the stability of electronic circuits by calculating the poles and zeros of the circuit's transfer function.

**Note** A pole is any number that will cause the denominator in a transfer function formula to be zero. A zero is any number that will cause the numerator in a transfer function formula to be zero.

A transfer function formula is a convenient way of expressing the behavior of analog circuits in the frequency domain. A transfer function is a Laplace Transform ratio of the output signal vs. input signal. The Laplace Transform of the output signal is commonly referred to as  $V_O(s)$  and the Laplace Transform of the input signal is referred to as  $V_I(s)$ . The parameter  $s$  stands for  $s=j\omega$ , more commonly known as  $s=j2\pi f$ .

A transfer function is generally a complex value given by the magnitude response (or transmission) and phase response. The Transfer Function of a circuit can be expressed by the following formula:

$$T(s) = \frac{V_O(s)}{V_I(s)} = \frac{K(s + z_1)(s + z_2)(s + z_3)(s + z_4)\dots}{(s + p_1)(s + p_2)(s + p_3)(s + p_4)\dots}$$

The numerator of the above formula contains the zeroes of the function  $(-z_1, -z_2, -z_3, -z_4, \dots)$  while the denominator of the function contains the Poles of the function  $(-p_1, -p_2, -p_3, -p_4, \dots)$ .

The zeroes of the function are those frequencies at which the transmission will be zero while the poles of the function are the natural modes of the network which define natural



frequencies. Both, poles and zeroes can contain either real, complex or purely imaginary numbers.

Determining the poles and zeroes from a transfer function formula will allow the designer to predict how a circuit design will perform under operation. Since pole and zero values are numeric (real or imaginary), it is important to understand how these numbers relate to circuit stability. Refer to the figure below to see how different poles affect circuit stability in response to a step impulse.

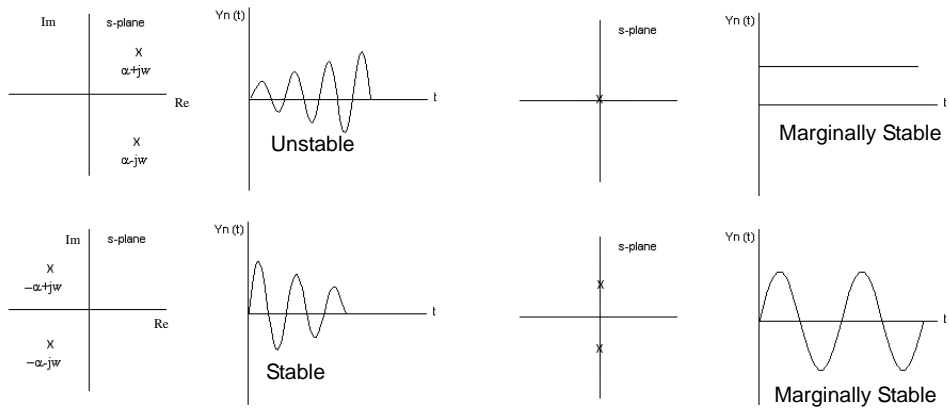

**Figure P3**

'X' is the pole or zero value

To illustrate this, we will analyze the following circuit.

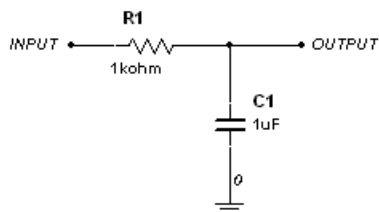

**Figure P1a (Circuit)**

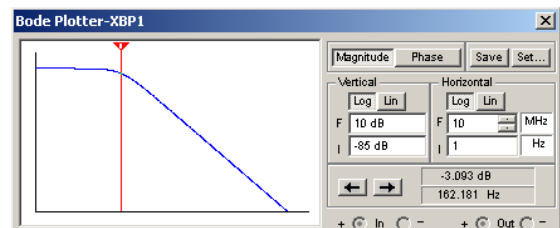

**Figure P1b (Circuit frequency response)**

Assuming this passive filter performs as expected in the frequency domain, we will examine how this circuit will react when a signal is injected to the input. Since we are only interested

in the initial response of the circuit, it is logical to test the circuit's response using a *step function*.

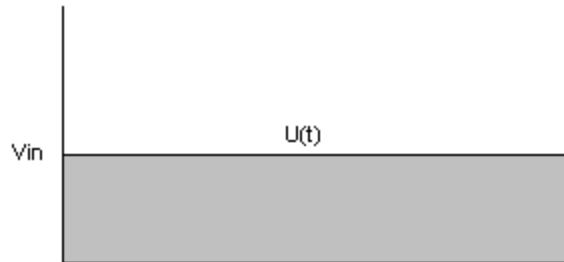

**Figure P2**

Analyzing the circuit in figure P1a, the following can be determined.

$$V_{out} = \left( \frac{Z_c}{R1 + Z_c} \right) V_{in}, \text{ where } Z_c \text{ is the capacitive reactance}$$

and

$$Z_c = \frac{1}{C1s}$$

The transfer function  $V_{out}/V_{in}$ :

$$\frac{V_{out}}{V_{in}} = \frac{\frac{1}{C1s}}{R1 + \frac{1}{C1s}} = \frac{1}{R1C1s + 1}$$

If  $C = 1\mu\text{f}$  and  $R = 1\text{K}\Omega$ , the following can then be determined:

$$\frac{V_{out}}{V_{in}} = \frac{1}{0.001s + 1} = \frac{1000}{s + 1000}$$

A pole is any number that will cause the denominator in a transfer function formula to be zero. In this case:

$$0 = s + 1000$$

$$s = -1000$$

Zeroes are any number that will cause the numerator in a transfer function formula to be zero. There are no zeroes in the above transfer function formula since the numerator does not contain an 's' term.

Referring back to figure P3, it is clear that this circuit is not unstable since the only pole in the above transfer function exists in the negative region of the s-plane.

### 11.16.1.1 Multisim Approach

**Pole Zero Analysis** computes the poles and/or zeroes in the small-signal AC transfer function. The program first computes the DC operating point and then determines the linearized, small-signal models for all the nonlinear devices in the circuit. This circuit is then used to find the poles and zeroes of the transfer function.

- output voltage / input voltage
- output voltage / input current

The result is a real and/or imaginary coordinate of the poles and/or zeroes, depending on which analyses are enabled.

**Note** The **Pole Zero Analysis** provides precise results on circuits containing passive devices (resistors, capacitors and inductors). Circuits containing active devices (transistor or opamps) will not always display the expected results.

## 11.16.2 Setting Pole Zero Analysis Parameters

Before you perform the analysis, review your circuit and decide on input and output nodes (positive and negative). The input nodes are the positive and negative points in the circuit which are the transfer function inputs. Likewise, the output nodes are the positive and negative points in the circuit which are the transfer function outputs. You can use 0 (ground) for both positive nodes or both negative nodes.

**Pole Zero Analysis** parameters are set in this dialog box:

Choose an analysis type: Gain Analysis (output voltage/input voltage), Impedance Analysis (output voltage/input current), Input Impedance (voltage/current as seen from the input terminals), Output Impedance (voltage/current as seen from the output terminals).

Choose input nodes.

Choose output nodes.

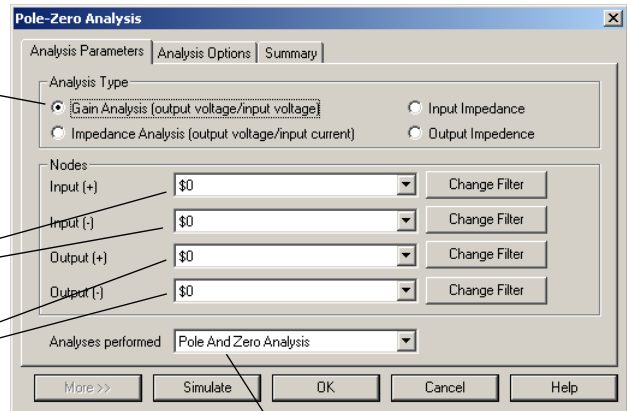

Choose analyses to be performed: Pole Analysis (finds poles of transfer function), Zero Analysis (finds zeroes of transfer function), Pole and Zero Analysis (finds both).

**Pole Zero Analysis** produces the real and imaginary coordinates of the poles and/or zeroes, depending on which analyses are enabled.

The **Pole Zero Analysis** provides precise results on circuits containing passive devices (resistors, capacitors and inductors). Circuits containing active devices (transistor or opamps) will not always display the expected results.

## Setting Pole Zero Analysis Parameters

For normal use, you only need to:

- select the analysis type by enabling the desired type
- select an input node from the **Input (+)** drop-down list and the **Input (-)** drop-down list
- select an output node from the **Output (+)** drop-down list and the **Output (-)** drop-down list
- select the analysis to be performed, by choosing from the **Analysis performed** list

For more advanced use, you can filter the variables displayed to include internal nodes (such as nodes inside a BJT model or inside a SPICE subcircuits), open pins, as well as output variables from any submodules contained in the circuit.

- To filter the variables displayed:
  1. Click **Change Filter**. The **Filter Nodes** dialog box appears.

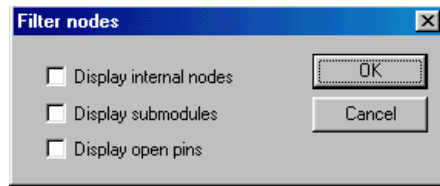

2. Enable one or more settings.
3. Click **OK**.

### 11.16.3 Running Pole Zero Analysis

For this pole zero example, we will use the following circuit:

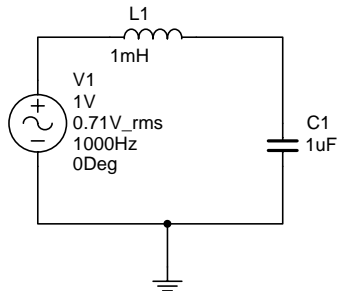

*Figure P4*

- To setup and run pole zero analysis using the circuit shown in Figure P4, we will follow the steps listed below.
  1. Select **Simulate/Analyses/Pole Zero**.
  2. In the **Pole-Zero Analysis** dialog, in the **Analysis Parameters** tab:
    - Set **Input (+)** to \$2 (input node).
    - Set **Input (-)** to \$0 (ground node).
    - Set **Output (+)** to \$1 (output node).
    - Set **Output (-)** to 0 (ground node).
    - Set the **Analyses Performed** option to Pole And Zero Analysis.

When complete, the **Analysis Parameters** tab should be set as shown below.

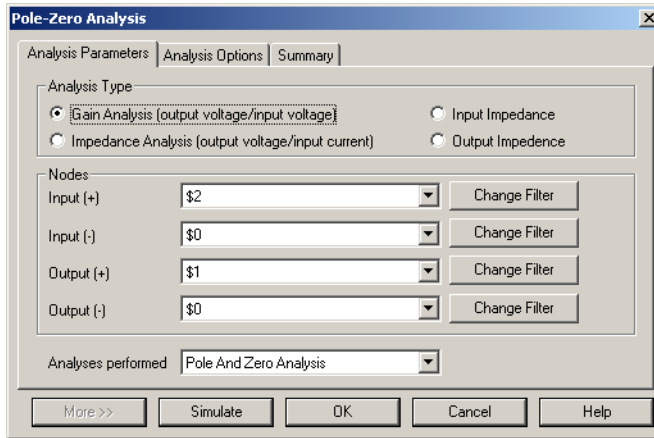

*Figure P5*

3. Click **Simulate**.

The Multisim grapher will appear displaying the following:

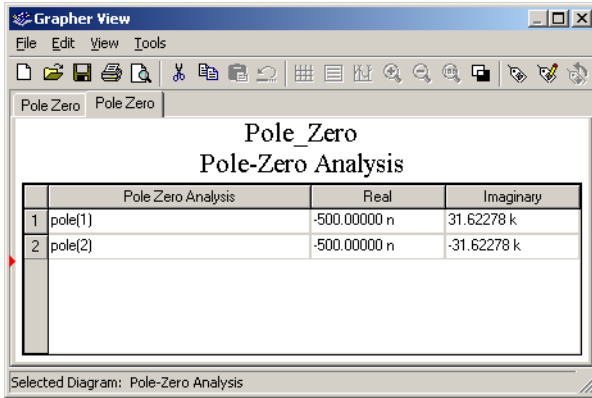

*Figure P6*

This graph indicates that two poles exist. One of the poles appears in the negative region and one in the positive region of the s-plane. Because one of the poles exists on the positive region of the s-plane, the stability of this circuit (figure P4) is poor according to figure P3.

## 11.17 Monte Carlo Analysis

### 11.17.1 About the Monte Carlo Analysis

**Monte Carlo Analysis** is a statistical technique that lets you explore how changing component properties affects circuit performance. **Monte Carlo Analysis** will perform **DC**, **AC** or **Transient Analysis** and vary the component properties. Multiple simulations are performed (also known as runs) and, for each run, the component parameters are randomly varied according to the distribution type and parameter tolerances specified by the user.

The first simulation is always performed with nominal values. For the rest of the simulations, a delta (controlled by the Lot Number) value is randomly added to or subtracted from the nominal value. This delta value can be any number within the *standard deviation* ( $\sigma$ ). The probability of adding a particular delta value depends on the probability distribution. The two probability distributions available are:

- *Uniform distribution* (also known as Flat Distribution)
- *Gaussian distribution* (also known as Normal Distribution)

#### 11.17.1.1 Uniform Distribution

A uniform distribution is one for which the probability of occurrence is the same for all values of  $x$ . This could be the component value within a specified tolerance. For example, if a fair die is thrown, the probability of obtaining any one of the six possible outcomes is  $1/6$ . Since all outcomes are equally probable, the distribution is uniform.

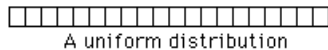

The distribution of a population can be described by several parameters such as the *mean* and *standard deviation*. The arithmetic mean is commonly called the average. The mean is the sum of all the observed properties divided by the number of observations.

The formula in summation notation is

$$\mu = \sum \frac{X}{N}$$

where  $\mu$  is the population mean and  $N$  is the number of scores.

## 11.17.1.2 Gaussian Distribution

Many statistical tests assume a gaussian distribution. Most of these tests work well even if the distribution is only approximately normal and in many cases as long as it does not deviate greatly from normality. Gaussian distributions are a family of distributions that have the shape shown below.



Gaussian distributions are symmetric with most observed properties concentrated in the middle than in the tails. They are defined by two parameters: the mean ( $\mu$ ) and the standard deviation (also know as  $\sigma$ , SD or Sigma).

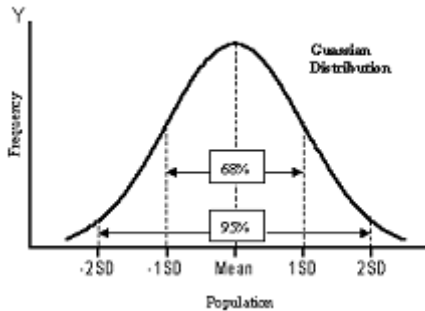

The formula for the height of a normal curve for a given value of x is:

$$\frac{1}{\sqrt{2\pi\sigma^2}} e^{-(x-\mu)^2 / 2\sigma^2}$$

The standard deviation ( $\sigma$ ) is calculated from the parameter tolerance according to:

$$\sigma^2 = \frac{\sum (X - \mu)^2}{N}$$

In Multisim, gaussian distribution will insure that only 68% of the population is within the specified tolerance. The remaining population will be outside the tolerance (specified by the



user). As an example, let us look at the gaussian distribution for a 1k resistor with 5% tolerance.

The standard deviation leads to a tolerance band of  $50 \Omega$ . Therefore, one standard deviation leads to a tolerance from  $0.95 \text{ k}\Omega$  to  $1.05 \text{ k}\Omega$  ( $1 \text{ k}\Omega \pm 50 \Omega$ ). Only 68% of the population will be within the tolerance of 5%. With a large enough sample, the  $\mu$  (mean) will be approximately 1000 ohms.

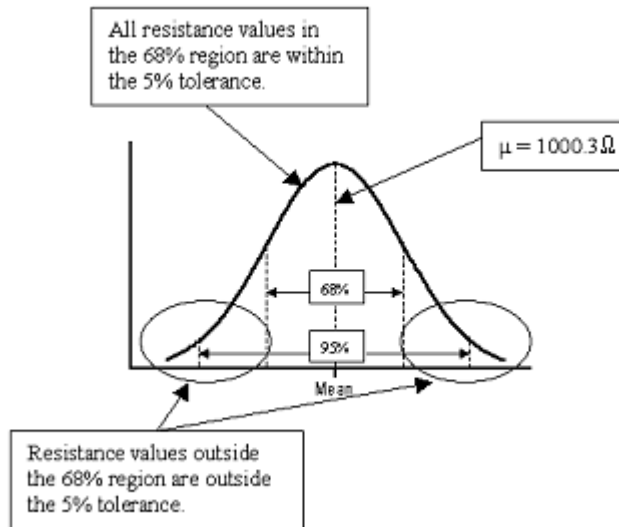

### Multisim approach

Multisim begins by performing a simulation using the nominal component values. For the rest of the simulations, a delta value is randomly added to or subtracted from the nominal value for each component/tolerance. This delta value can be any number within the standard deviation. The probability of adding a particular delta value depends on the probability distribution, which is selected by the user (for each component tolerance).

## 11.17.2 Setting Up and Running Monte Carlo Analysis

- To start Monte Carlo Analysis, select **Simulate/Analyses/Monte Carlo**. The **Monte Carlo Analysis** dialog box displays.

### 11.17.2.1 Entering a Component Tolerance

- To enter component tolerances:
  1. Click **Add a new tolerance** in the **Model tolerance list** tab. The **Tolerance** dialog box displays.

2. Specify the following:
  - **Parameter Type**—Select Device Parameter in the drop-down list. This option allows you to select which component (R1, U5, etc) will be included in a tolerance. In addition, this section allows you to select the parameter to be used in this tolerance (eg: Resistance, Temperature Coefficient, etc).
  - **Distribution**—Select either Uniform or Gaussian.
  - **Lot number**—This option is used to control the delta value added or subtracted from the nominal tolerance value. Each Lot number contains a different utility used to generate random data (same number generation for various parameters). Choose Unique if you need each random number generation distinct for every parameter.

- **Tolerance Type**—This option allows the user to specify if the tolerance value is a percentage of the component value) of a specific amount of the component value (eg: Using a resistor, if the Tolerance Type is Absolute and the Tolerance Value is 20, the component tolerance will be +/-20  $\Omega$ ).
  - **Tolerance value**—This option allows the user to set the magnitude of the tolerance (in percent or absolute depending on what is selected in the Tolerance Type option).
3. Click **Accept**.

### 11.17.2.2 Specifying Monte Carlo Analysis Parameters

Analysis parameters are set in the **Analysis Parameters** tab as described below.

**Note** For details on the other tabs in the analysis window, see “11.3.3 The Output Tab” on page 11-24, “11.3.5 The Analysis Options Tab” on page 11-29 and “11.3.6 The Summary Tab” on page 11-30.

1. **Analysis**—This option allows the user to specify what type of simulation Monte Carlo will perform for each run. There are three options:
  - Transient Analysis (time domain)
  - DC Operating Point (DC operating point of every node in the circuit)
  - AC Analysis (frequency domain)
2. **Number of runs**—This option allows the user to specify how many simulations Monte Carlo will generate. Each simulation will use a slightly different component value.
3. **Analysis Expressions** - As well as being able to select a node in the **Output Variable** field, you can click on the **Expression** checkbox and enter an analysis expression in the **Output Variable** field. When the **Expression** checkbox is enabled, the **Change Filter** button changes to the **Edit Expression** button. You can click this to view the **Analysis Expression** dialog box where you can enter and edit expressions. For details, see “11.3.4 Adding Analysis Expressions” on page 11-27.
4. **Collating Function and Threshold**—There are four options available:
  - **MAX**—This option will inform the user (when the Monte Carlo results have been generated) what the maximum voltage (peak) is for each run.
  - **MIN**—This option will inform the user (when the Monte Carlo results have been generated) what the minimum voltage (peak) is for each run.
  - **RISE\_EDGE**—This option will inform the user (after Monte Carlo has generated the results) the time when the signal reached the *threshold* voltage on the first rising edge of the waveform. As an example:

A 1 KHz Sine wave generator is connected to a voltage divider. If the threshold setting is 0 (volts), Monte Carlo will generate a ‘worst case value’ of zero (since the waveform exceeds the threshold voltage (0 volts) at zero seconds).

Refer to figure below.

- **FALL\_EDGE**—This option will inform the user (after Monte Carlo has generated the results) the time when the signal reached the *threshold* voltage on the first falling edge of the waveform. As an example:

A 1 KHz Sine wave generator is connected to a voltage divider. If the threshold setting is 0 (volts), Monte Carlo will generate a ‘worst case value’ of 0.001 since the waveform exceeds the threshold voltage on the negative edge at 0.0005 seconds (half of the period).

Refer to figure below.

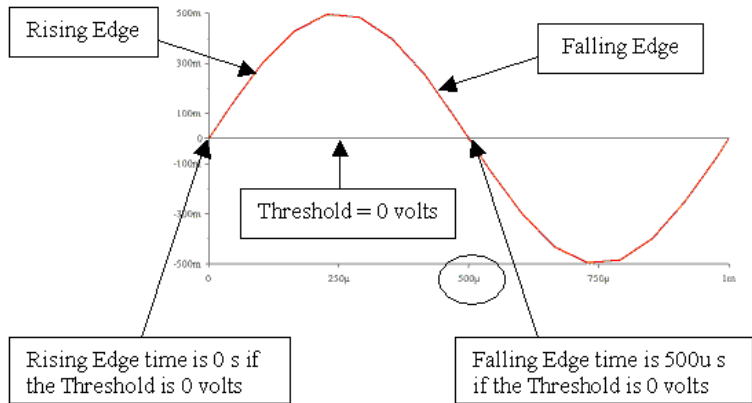

### 11.17.3 Monte Carlo Analysis Example

This example analyses the following circuit at node 6. Details follow.

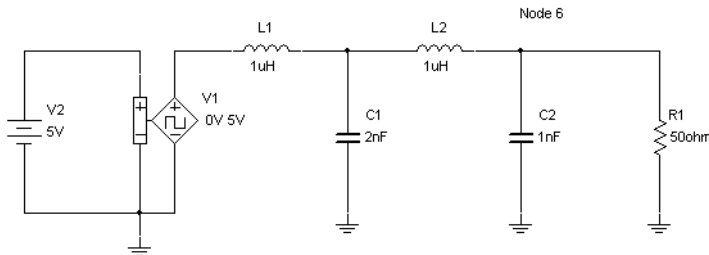

### 11.17.3.1 Setting up the Sample Monte Carlo Analysis

- To set up the sample analyses:
1. Fill in the data as shown below.

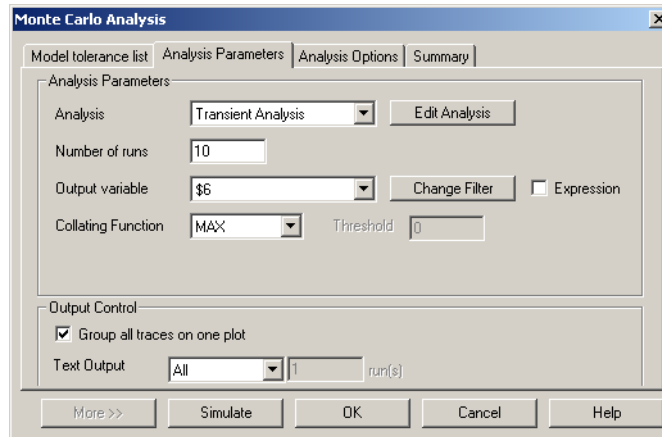

2. Click **Edit Analysis** to modify the transient analysis to be used for the simulation and change the parameters as shown below.

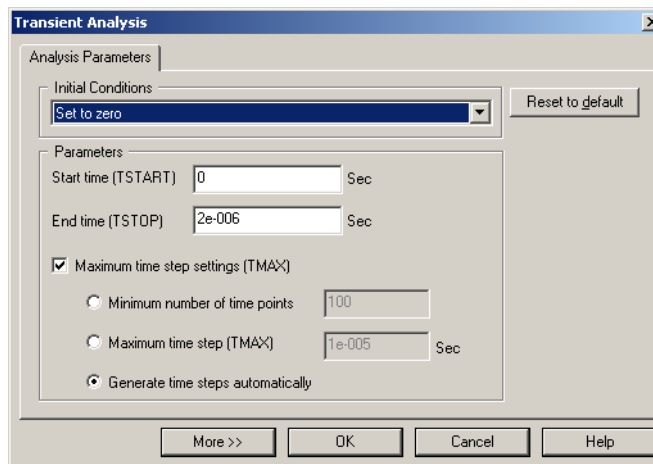

3. Click **OK**.
4. Click on **Model tolerance list** tab, to specify component to vary during the simulation.

5. Click on **Add a new tolerance** and enter all information in the field as shown below.

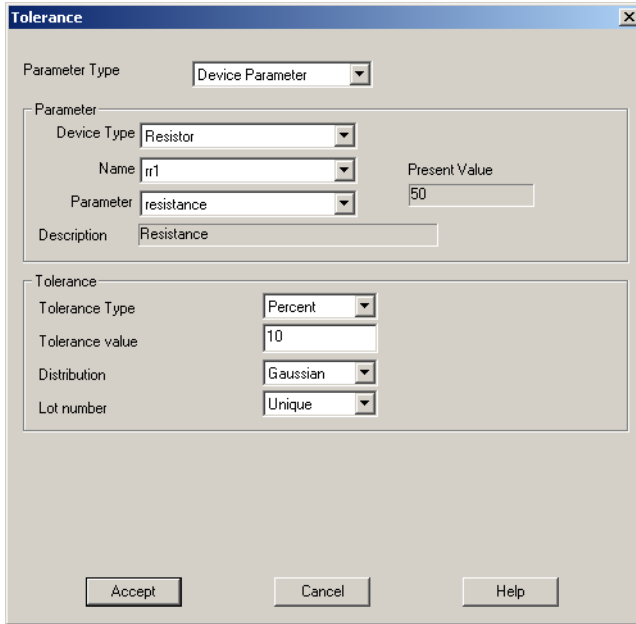

6. Click **Accept**. The model tolerance should appear as below.

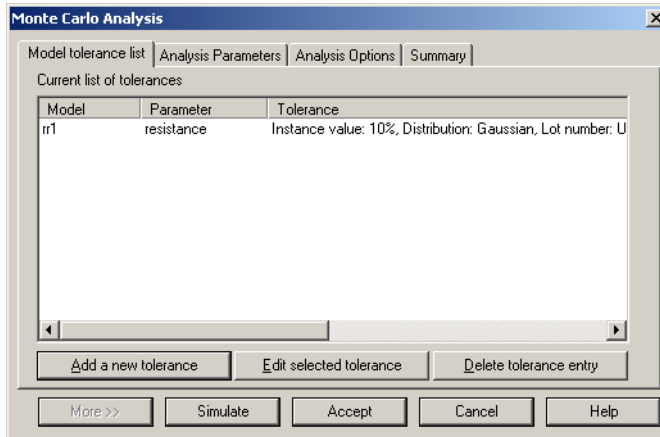

**Note** To add more than one component to be varied during simulation, click **Add a new tolerance** again, and add new information.

7. Click **Simulate** to run the simulation.

### 11.17.3.2 Simulation Results

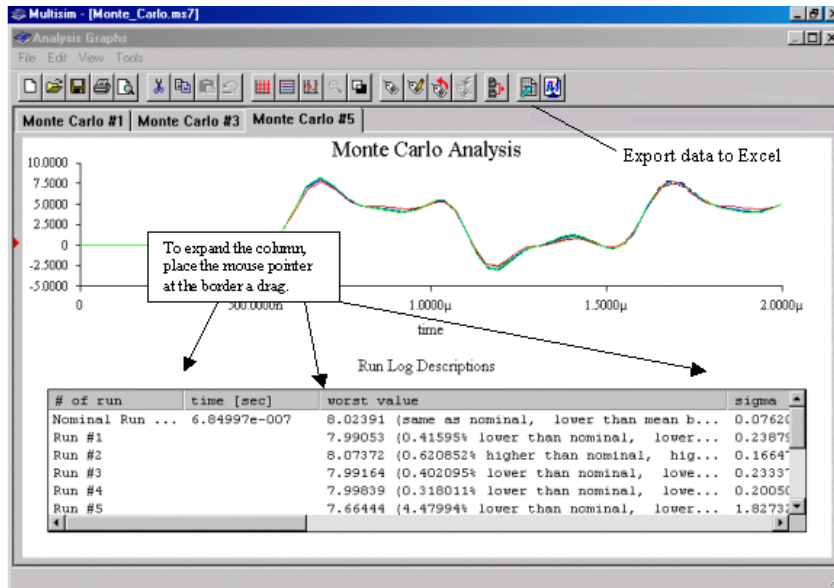

**Note** The results of your simulation may be different than what is shown above.

- To export Voltage vs. Time data from the graph, click on the graph to make it active. Now click the **Excel** icon to export the data.
- To export the data under **Run Log Descriptions** to Excel, place the mouse pointer within the data box and click once to make it active. Now click on the **Excel** icon. Excel should start automatically. See table below.

Run	Time (sec)	Voltage (V)	Sigma	Resistance (Ω)
Nominal	6.84997e-007	8.02391	0.0762047	50
1		7.99053	0.238791	49.3672
2		8.07372	0.166473	50.9656
3		7.99164	0.233375	49.3881
4		7.99839	0.200508	49.5152

5		7.66444	1.82732	43.8137
6		8.28861	1.21325	55.445
7		8.28717	1.20627	55.4133
8		7.68974	1.70408	44.2215
9		8.14702	0.523529	52.4342
10		8.27988	1.17076	55.2525

The data in the above table are extracted from **Run Log Descriptions**. The **Voltage** column refers to the first value under the **Worst value** column.

Output mean = 8.03955

Standard Deviation = 0.205279

The mean and standard deviation can be found under the **# of Run** column. You must expand this column to view this information.

The **Time** column in the above table indicates the instance where the voltage reaches maximum level. This is defined in the **Function** field in the **Analysis Parameters** tab.

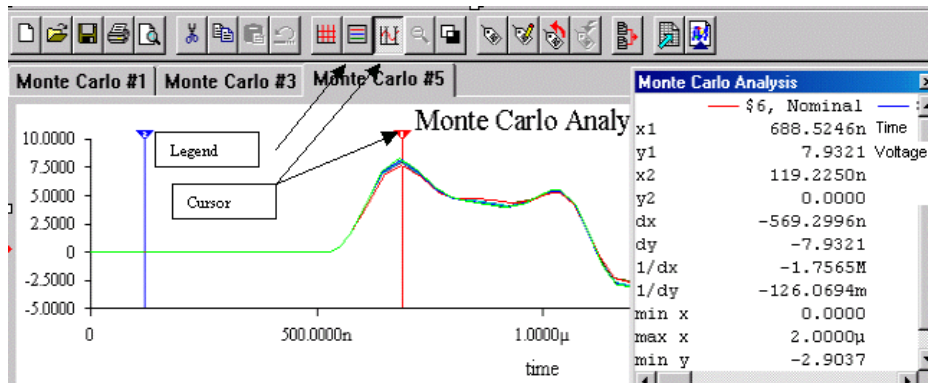

The cursor in the above figure is approximately placed at the time where voltage reaches the max value (X1 in the cursor table). This is the same value that Multisim shows under voltage column (Y1 in the cursor table).



Calculating the Mean value from the table in “11.17.3.2 Simulation Results” on page 11-111:

$$\mu = \frac{\sum_{n=1}^n V_n}{n}$$

where  $V_n$  = voltage at each run  
 $\mu$  = mean value  
 $n$  = number of runs (not including nominal run)

$$\mu = \frac{7.99 + \dots + 8.27}{10} = 8.04 \text{ V}$$

Standard Deviation:

$$s^2 = \frac{\sum_{n=1}^n (V_n - \mu)^2}{n}$$

where  $s$  = standard deviation  
 $V_n$  = voltage at each run  
 $\mu$  = mean value  
 $n$  = number of runs (not including nominal run)

$$s = \sqrt{\frac{(7.99 - 8.04)^2 + \dots + (8.27 - 8.04)^2}{10}} = 0.215$$

Finding **Sigma** for the table in “11.17.3.2 Simulation Results” on page 11-111:

Note sigma corresponds to resistance value data and not the voltage value from the above calculation. First we need to calculate the mean and standard deviation for the resistance data.

$$\mu = \frac{\sum_{n=1}^n R_n}{n}$$

where  $R_n$  = resistance at each run  
 $\mu$  = mean value  
 $n$  = number of runs (not including nominal run)

$$\mu = \frac{49.36 + 50.96 + \dots + 55.25}{10} = 50.58 \Omega$$

Finding the exact value for sigma requires the equation for the distribution curve. For our purpose we will use an approximation method to find sigma. We will use Run 10, since this will give us the closest value to the simulated results.

At 1 standard deviation:

$$s^2 = \frac{\sum_{n=1}^n (R_n - \mu)^2}{n}$$

where  $R_n$  = resistance at each run  
 $\mu$  = mean value  
 $n$  = number of runs (not including nominal run)

$$s = \sqrt{\frac{(49.36 - 50.58)^2 + (50.96 - 50.58)^2 \dots + (55.25 - 50.58)^2}{10}} = 4.03$$

## 11.18 Trace Width Analysis

**Trace Width Analysis** calculates the minimum trace width needed in the circuit to handle the RMS current at any trace/wire. The RMS current is derived from simulation. To fully understand the importance of this analysis, we must first understand what happens to a trace or wire as current increases on that wire.

The flow of current through a trace will cause the temperature of the trace to increase. The formula for power is  $P = I^2R$ , so the relationship is not simply linear with respect to current. The resistance of a trace (per unit length) is a function of its cross-sectional area (width times thickness). The relationship between temperature and current, therefore, is a non-linear function of current, trace width, and trace thickness. The ability of a trace to dissipate heat is a function of its surface area, or width (per unit length).

The PCB layout technology limits the thickness of the copper used for wires. This thickness is related to the nominal weight, which is provided in OZ/f + 2, in the form of a table.

### Understanding how trace width is determined

A common model in thermodynamics for current in a trace is:

$$I = K * \Delta T^{B1} A^{B2}$$

where:

I = current in amps

$\Delta T$  = change in Temperature above ambient, in degrees C

A = cross sectional area in square mils, and K, B1 and B2 are constants

This is the starting point for McHardy and Gandi.

To estimate the coefficients for the above equation, it is convenient first to convert them to linear form. We can do this by using logarithms, as follows:

$$\ln(I) = \ln(K) + B1 * \ln(\Delta T) + B2 * \ln(A)$$

Where  $\ln()$  is the natural logarithm (to the base e).

### DN Data

DN sources are charts relating temperature change and current for various trace configurations. The DN data provides information allowing the independent evaluation of length and width for the traces under study.

When all DN data is used in a regression analysis, we get the following estimate:

$$\ln(I) = -3.23 + 0.45 * \ln(\Delta T) + 0.69 * \ln(A)$$

which leads to:

$$I = 0.04 * \Delta T^{0.45} A^{0.69}$$

Below is a graph plotting approximately 300 data points from the above formula.

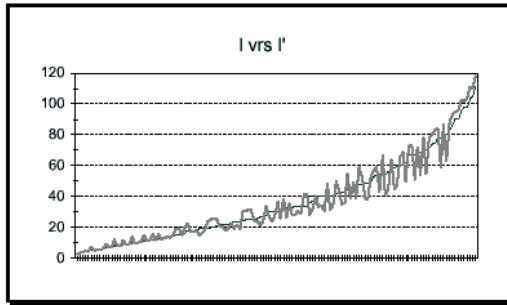

Figure 1  
Graph of Actual vs Estimated Current from DN Data  
Using Eq. 5

## 11.18.1 Multisim Approach

Multisim uses the trace weight value (oz/ft<sup>2</sup>) to calculate the required thickness for **Trace Width Analysis**. See the table below for the assumed trace thickness for each copper weight. Using transient analysis, the currents of each wire are calculated first. These currents are usually time dependent, that is, their amplitude changes in time to a positive or negative value.

### Trace Width

Thickness	Weight
1.0/8.0	.2
.0/4.0	.36
3.0/8.0	.52
1.0/2.0	.70
3.0/4.0	1
1	1.40

## Trace Width

Thickness	Weight
2	2.80
3	4.20
4	5.6
5	7.0
6	8.4
7	9.80
10	14
14	19.60

Since the transient analysis is performed for discrete time points, the accuracy of the maximum absolute value depends on how many time points are selected. Here are a few recommendations to increase the accuracy of Trace Width Analysis:

- Set the end time of the transient analysis (visible in the **Analysis Parameters** tab) to a time point where at least one cycle of the signal is processed. This is particularly the case if the signal is periodic. If not, you must set the end time to a value large enough for Multisim to capture the correct maximum current.
- Manually increase the number of points to 100 or more. The more points of the signal, the more accurate the maximum value. Note that increasing the number of time points beyond about 1000 will increase the execution time and slow down Multisim.
- Consider the effect of the initial condition, which can change the maximum of the signal at starting time. It may slow down the simulation if the steady state (DC operating point, for example) is far from the initial condition (say, zero IC).

Once  $I$  and  $\Delta T$  are known, Multisim uses the McHardy and Gandhi formula to find the width of the wire. The formula is:

$$I = KT^{0.44} A^{0.725}$$

where:

$I$  = maximum current in Amps

$K$  = derating Constant (0.024 for inner)

$T$  = maximum temperature rise above ambient in  $\times C$

$A$  = cross-sectional area in square mils (*not* millimeters)

Note that one "mil" is 1/1000 of an inch.

## 11.18.2 Sample Trace Width Analysis

To perform this analysis using Multisim, we will use the following circuit:

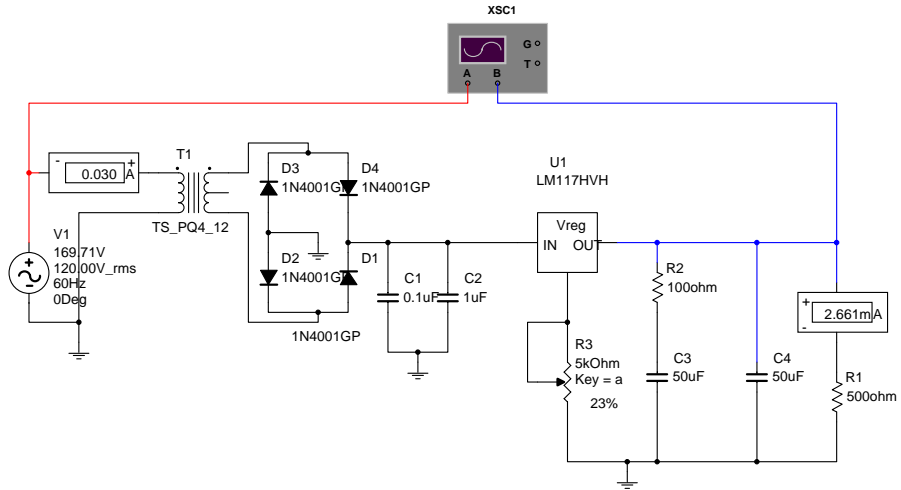

Notice that the input signal is 120V AC (RMS). The input signal and the output signal are shown below using the Multisim Oscilloscope.

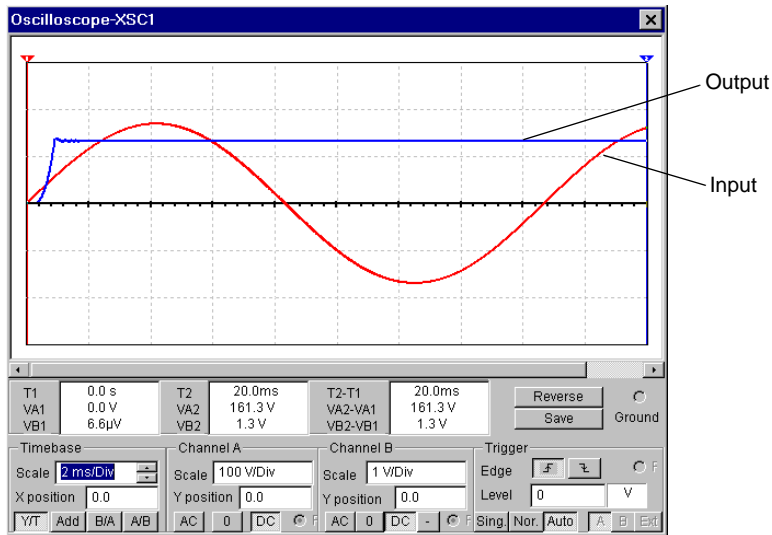

- To set up **Trace Width Analysis**:
1. Select **Simulate/Analyses/Trace Width Analysis**.
  2. Select the **Trace Width Analysis** tab, and set the following:
    - **Maximum temperature above ambient** to 10 (degrees C).
    - **Weight of plating** to 1 (oz/ft<sup>2</sup>).

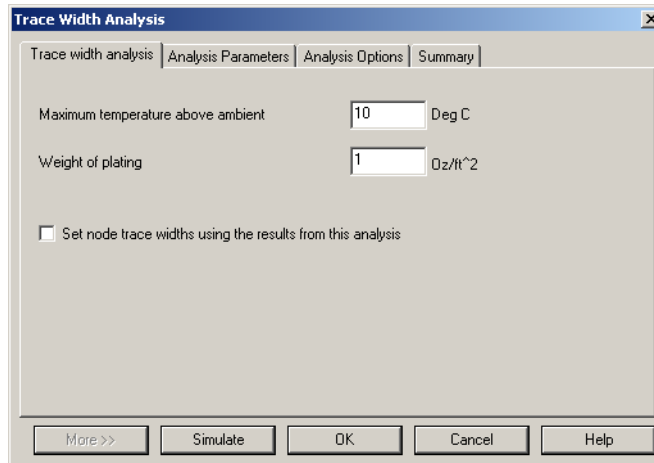

3. Select the **Analysis Parameters** tab and choose **Set To Zero** from the **Initial Conditions** drop-down list.

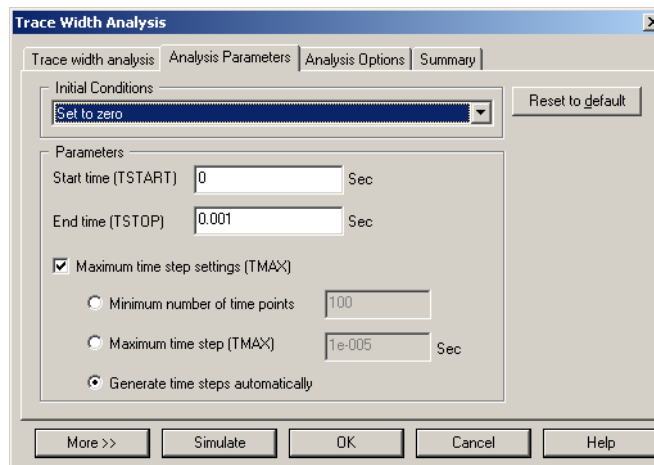

4. Click **Simulate**. The following displays.

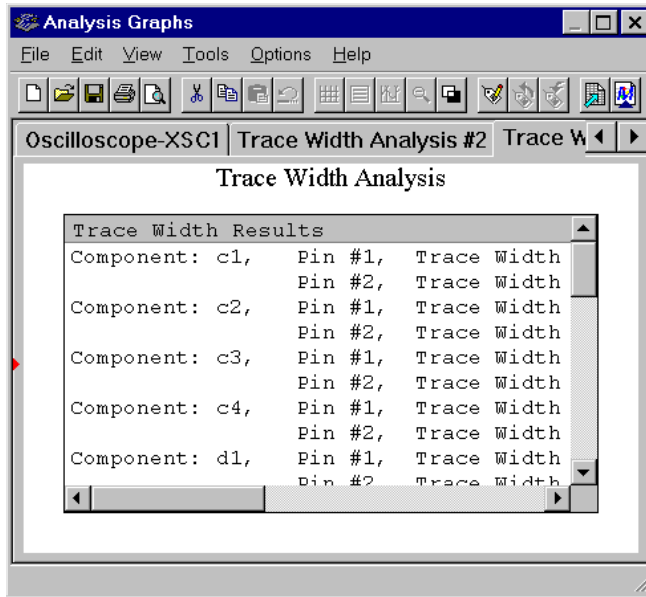

Maximize this window to view the complete results. These results are listed below:

Component: c1,

- Pin #1, Trace Width = 0.270535 mils
- Pin #2, Trace Width = 0.270535 mils

Component: c2,

- Pin #1, Trace Width = 0.270535 mils
- Pin #2, Trace Width = 0.270535 mils

Component: c3,

- Pin #1, Trace Width = 0.0819493 mils
- Pin #2, Trace Width = 0.0819493 mils

- 
- 
- 

Component: t1,

- Pin #1, Trace Width = 3.60528 mils
- Pin #3, Trace Width = 3.60528 mils
- Pin #4, Trace Width = 0.465827 mils
- Pin #5, Trace Width = 0.465827 mils



Trace Width Analysis determines that the minimum trace width required to pin 1 of T1 (transformer) is 4.07095 mils.

Therefore, in order to insure that the connection between the input source and transformer T1 operates successfully, the trace width must be a minimum of 4.0 mils when the PCB board is created.

## 11.19 RF Analyses



RF analyses (Characterizer, Noise Figure and Matching Networks analyses) are performed through the Network Analyzer instrument and are described in “15.4 RF Analyses” on page 15-18.

## 11.20 Nested Sweep Analyses



Temperature Sweep and Parameter Sweep analyses can be performed in a nested fashion, with a series of sweeps being performed, each within the constraints of the sweep before it. For example, you could perform a temperature sweep on the results of a parameter sweep.

- To perform a **Nested Temperature** or **Parameter Sweep Analysis**:
  1. Open the **Parameter Sweep** dialog box by choosing either **Temperature Sweep** or **Parameter Sweep** from the **Analyses** menu.
  2. From the **Analysis to Sweep** drop-down list, select **Nested Sweep**.

3. Click **Edit Analysis**. The **Nested Parameter Sweep** dialog box appears. The top line indicates you are defining nested sweep level 1.

The label of the dialog box indicates this is the first level sweep.

Because you are defining a portion of a nested sweep analysis, you cannot simulate from this dialog box. Click OK or Cancel to display the previous nested sweep level.

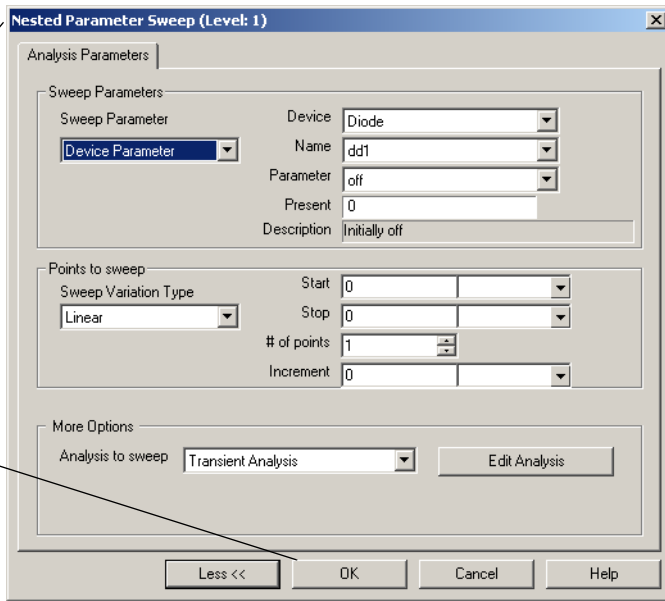

4. Set the parameters as desired.
5. To create another level of the nest, again select **Nested sweep** from the **Analysis to sweep** drop-down list.
6. Click **Edit Analysis**. A new **Nested Parameter Sweep** dialog box appears, this time indicating that you are at nest Level 2.
7. You can continue to add nested sweeps by repeating this procedure.
8. To return to the higher level, saving your changes, click **OK**. To return to the higher level without saving your changes, click **Cancel**.
9. When all nested analyses have been defined, click **Simulate**.

## 11.21 Batched Analyses



You can batch together different analyses, or different instances of the same analysis, to be performed in sequence. This provides a convenient way for advanced users to perform multiple analyses from a single, interpreted command.

For example, you might use batched analyses to:

- repeatedly perform the same set of analyses, such as when trying to fine-tune a circuit
- build a record of the analyses that you performed on the circuit
- set up a sequence of long running analyses to run automatically.

➤ To set up batched analyses:

1. Choose **Analysis/Batched Analyses**. The **Batched Analyses** dialog box appears:

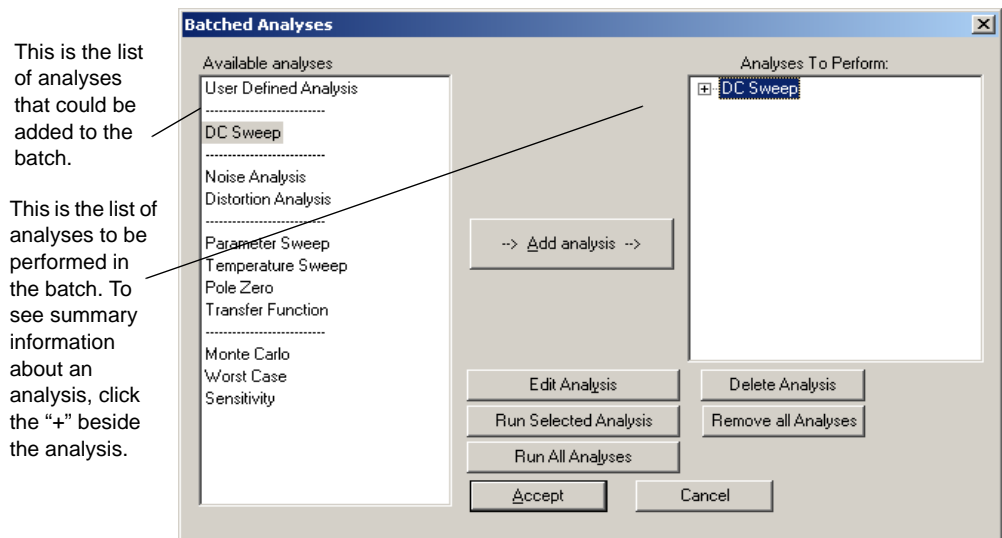

2. To add an analysis to the batch, select it and click the **Add Analysis** button. The parameters dialog box for the selected analysis appears, so you can set the parameters for the analysis.
3. When you have finished the settings for the analysis, click **Add to List**.

The analysis is added to the **Analyses to Perform** list on the right. Summary information can be revealed by clicking the "+" beside the analysis.

4. Continue to add analyses as desired. Note that the settings for one instance of an analysis become the default settings for that analysis during this operation. For example, if you set your first DC Sweep to an increment of 0.6, the 0.6 increment is the default value when you add your next DC Sweep to the batch.

5. To run just one of the analyses in the batch, select it and click **Run Selected Analysis**. To run all of them, click **Run All Analyses**.
- To edit an analysis' parameters in the batch, select it and click **Edit Analysis**. The selected analysis' parameters dialog box appears, allowing you to make any modifications you wish to the analysis.
  - To remove an analysis from the batch, select it and click **Delete Analysis**. To remove all analyses, click **Remove All Analyses**.

## 11.22 User Defined Analyses

### 11.22.1 About the User Defined Analysis



The **User Defined Analysis** allows you to manually load a SPICE card or netlist and type in SPICE commands. This gives you more freedom to adjust a simulation rather than using the graphical interface of Multisim. However, a thorough knowledge of SPICE is essential.

To demonstrate the **User Defined Analysis**, three Berkeley SPICE 3F5 compatible SPICE netlists are simulated in the following sections.

Enter the list of SPICE commands to execute.

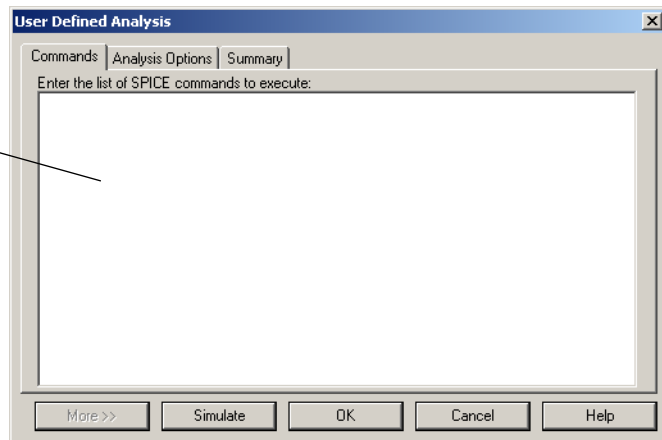

## 11.22.2 Creating and Simulating a SPICE Netlist

This example will create and simulate the following SPICE netlist.

```
*Basic RC Circuit
v1 1 0 sin(0 1 1000)
r1 1 2 1000
c1 2 0 1e-6
.tran 0.1m 1m
.end
```

- To create a SPICE netlist:
  1. Type the netlist into any text editor, as in the example shown above.
  2. From the text editor, select **File/Save As**.
  3. In the dialog box that appears, enter `Rc.cir` for the filename and select `C:\Temp` for the filepath.
  
- To run the **User Defined Analysis**:
  1. Select **Simulate/Analyses/User Defined Analysis**.
  2. In the **Commands** tab of the **User Defined Analysis** dialog box, enter the syntax shown below.

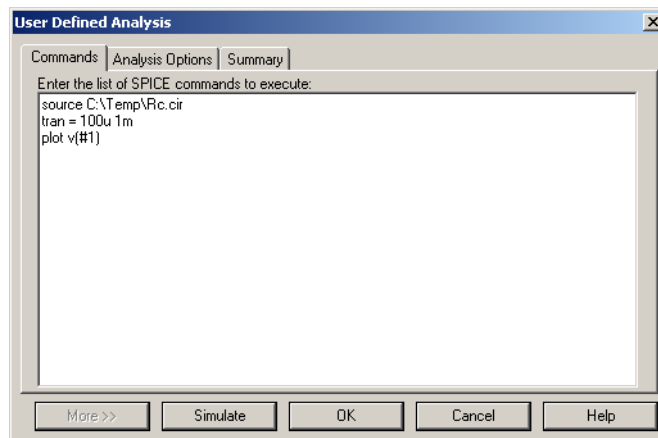

3. Click **Simulate**.

**Note** Multisim gives you the option of using an equal sign after the statement i.e. tran = 100u 1m or tran 100u 1m. Both revisions of the “tran” statement work. In addition, if you would like to have a smoother waveform, reduce the step value from 100u to 1u.

The waveform example in the figure below will appear on the your display grapher in Multisim.

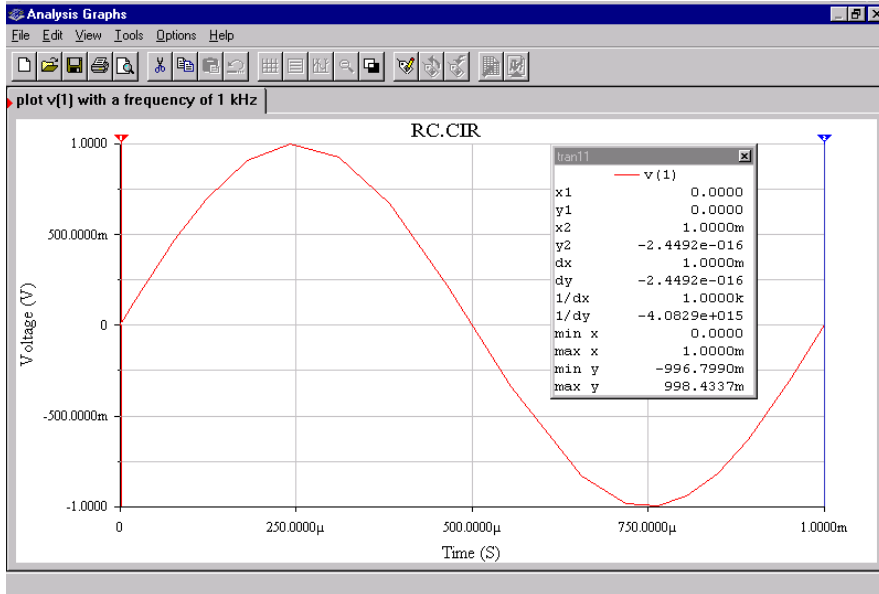

### 11.22.3 Importing the SPICE netlist into Multisim

- To import the R.c.cir SPICE netlist into Multisim:
  1. Select **File/Open**. Click on the drop-down arrow next to “Files of type”, and select Spice Netlist Files (\*.cir).

2. Select the file `Rc.cir` from the `C:\Temp\` directory and click on the **Open** button. The `Rc.cir` file imports into Multisim and shows the schematic equivalent of the text-based SPICE netlist.

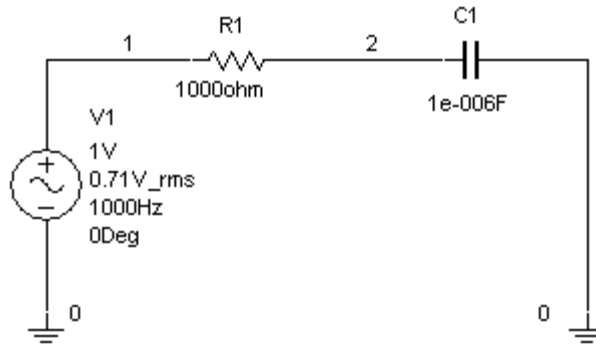

3. Select **File/Save As** and name the file `Rc.ms8`.

## 11.22.4 Plotting Two Nodes Using the Tran Statement

- To plot two nodes using the tran statement enter the syntax shown below.
  - First line shows the path and loads the SPICE netlist file
  - Second line shows the “tran” statement with a 1u step value and a final stop value of 2m
  - plot v(\$1) v(\$2) will plot nodes 1 and 2 on the display grapher.

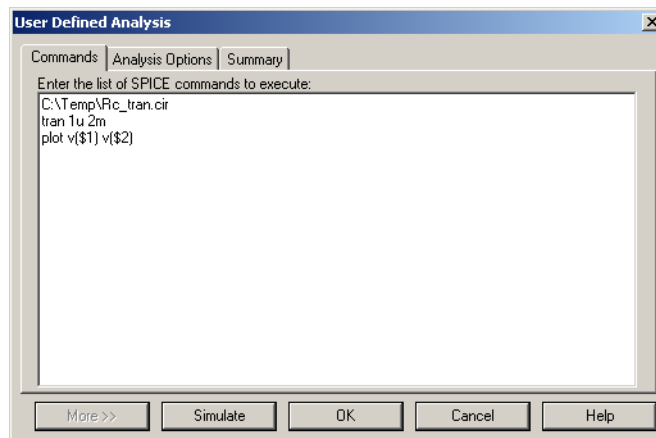

## 11.22.5 How to Run an AC Analysis

- To run an AC Analysis, enter the syntax shown below
  - First line shows the path to the SPICE netlist file.
  - Second line shows “ac” statement, type of sweep “dec” (decade), step value, start of sweep (1Hz) and end of sweep 1000 Hz.
  - NOTE: A period is not required before the statement i.e. “.ac”. Use “ac” without quotation marks.
  - Third line assigns plot v(\$2) or graphs a voltage at node 2. Plot will always turn on the display grapher in Multisim.

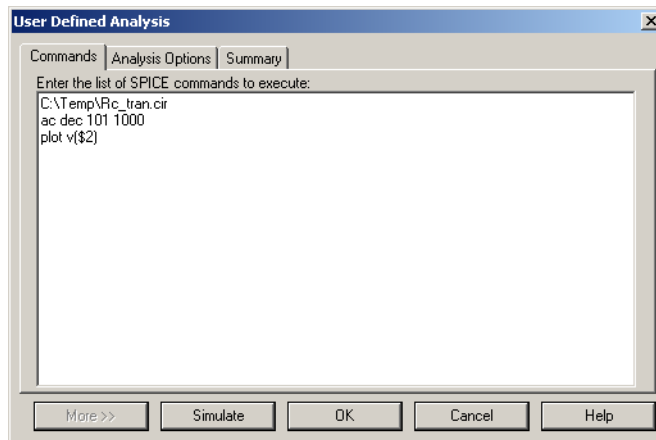



The waveform using the plot v(2) statement will appear as follows.

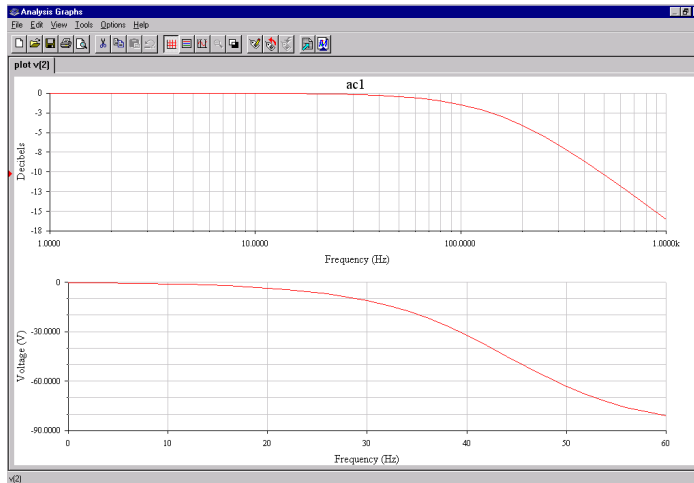

## 11.23 Analysis Options dialog box

Multisim lets you control many aspects of the simulation used within the analyses, such as resetting error tolerances, selecting simulation techniques and viewing the results. Simulation efficiency is also dependent on the options you choose.

This section briefly describes the simulation options you have for controlling simulation used within the analyses and lists their default values. You will find these options through the **Analysis Options** tabs of the various analyses dialog boxes, as explained in “11.3.5 The Analysis Options Tab” on page 11-29.

## 11.23.1 Global tab

Code	Option Name	Description	Default	Unit	Recommendation
ABSTOL	Absolute error tolerance	Resets the absolute current error tolerance. Default is suitable for most bipolar transistor VLSI circuits.	1.0e-12	A	
VNTOL	Voltage error tolerance	Resets the absolute voltage error tolerance of the program.	1.0e-06	V	Generally, set to 6 to 8 orders of magnitude smaller than the largest voltage signal in the circuit.
CHGTOL	Charge error tolerance	Resets the charge tolerance in coulombs.	1.0e-14	C	Do not change default.
RELTOL	Relative error tolerance	Resets the relative error tolerance of the simulation, which is the universal accuracy control. The value can significantly affect the convergence of the solution and the simulation speed. Value must be between 1 and 0.	0.001	-	Use typical values between 1.0e-06 and 0.01.
GMIN	Minimum conductance	Resets the minimum conductance used in any circuit branch. Cannot be zero. Increasing this may positively improve the convergence of the solution; however, it will also negatively affect simulation accuracy.	1.0e-12	mho	Do not change default.
PIVREL	Minimum acceptable ratio of pivot	Resets the relative value between the largest column entry in the matrix and an acceptable pivot value. Value must be between 1 and 0.	0.001	-	Do not change default.
PIVTOL	Minimum acceptable pivot	Resets the absolute minimum value for a matrix entry to be accepted as a pivot.	1.0e-13	-	Do not change default.
TEMP	Operating temperature	Resets the temperature at which the entire circuit will be simulated. Setting in the Analysis Parameters dialog box will override.	300.15	°K	-

Code	Option Name	Description	Default	Unit	Recommendation
RSHUNT	Shunt resistance from analog nodes to ground	Inserts resistance to ground at all analog nodes in the circuit. Reducing value reduces simulation accuracy.	Disabled (1.0e12 when disabled)	$\Omega$	Should be set to some very high resistance, say $1e+12\Omega$ . If you get a "No DC path to ground" or a "Matrix is nearly singular" error message, try decreasing RSHUNT to $1e+9\Omega$ or $1e+6\Omega$ .
RAMPTIME	Transient analysis supply ramping time	Ramps independent sources, capacitor and inductor initial conditions from zero to their final values during the time period specified.	0	s	-
CONVSTEP	Fractional step allowed by code model inputs between iterations	Controls automatic convergence assistance by establishing a relative step size limit in solving for the DC operating point.	0.25	-	-
CONVABSSTEP	Absolute step allowed by code model inputs between iterations	Controls automatic convergence assistance by establishing an absolute step size limit in solving for the DC operating point.	0.1	-	-
CONVLIMIT	Enable convergence assistance on code models	Enables/disables a convergence algorithm used in some built-in component models.	ON	-	-
ACCT	Print simulation statistics	Turns on/off display of statistical data on simulation-related information. Data may be useful for debugging simulation-related problems. Data appears in the Grapher dialog box.	Off	-	-

## 11.23.2 DC tab

Code	Option Name	Description	Default	Unit	Recommendation
ITL1	DC iteration limit	Resets the upper bound limit to the number of Newton-Raphson iterations during a DC operating point analysis.	100	-	If you receive the error message "No convergence in DC analysis", increase the ITL1 value to 500 or 1000 and rerun the analysis.
ITL2	DC transfer curve iteration limit	Resets the DC transfer curve iteration limit.	50		
ITL6	Steps in source stepping algorithm	Sets the number of steps in the Gmin stepping algorithm. Helps find a solution during a DC operating point analysis. See "9.3.6 Convergence Assistance Algorithms" on page 9-11 for more information.	10	-	-
GMINSTEPS	Number of Gmin steps	Sets the number of steps in the Gmin stepping algorithm. Helps find a solution during the DC operating point analysis. See "9.3.6 Convergence Assistance Algorithms" on page 9-11 for more information. If a zero value is specified, the Gmin stepping algorithm is disabled.	10	-	-
NOOPITER	Go directly to Gmin stepping		-	-	

## 11.23.3 Transient tab

Code	Option Name	Description	Default	Unit	Recommendation
ITL4	Upper transient iteration limit	Resets the upper bound limit to the number of Newton-Raphson iterations at each transient time point. Increasing the value may slow down transient simulation time. Decreasing the value increases the chance of in-convergence.	100	-	If you receive the error message "Time step too small" or "No convergence in transient analysis", increase the ITL4 value to 15 and rerun the analysis.
MAXORD	Maximum integration order	Sets the maximum order for integration when GEAR chosen as transient analysis integration method. Must be between 2 and 6. Using a higher order theoretically leads to more accurate results, but slows down simulation.	2	-	Use the default value for most circuit simulation.
TRTOL	Truncation error overestimation factor	Resets transient error tolerance. Only used in the local truncation error criterion.	7	-	Use default value
METHOD	Integration method	Selects for transient analysis. Default provides faster simulations with same numerical accuracy, but can produce unintended results.	TRAPEZOIDAL	-	Use GEAR (gear integration method) if unwanted numerical oscillations occur during simulation or if circuit contains ideal switches. Use default if circuit operates in oscillation mode, for example, oscillator circuits. Be aware that Gear integration may overdamp results.

## 11.23.4 Device tab

Code	Option Name	Description	Default	Unit	Recommendation
TNOM	Nominal temperature	Resets the normal temperature at which model parameters are measured and calculated.	300.15	°K	Do not change unless you want your circuit to match data book specifications that were extracted at a temperature other than 300.15 °K.
BYPASS	Allow bypass of unchanging elements	Turns off/on the device bypass scheme for nonlinear model evaluation. Turning off may increase simulation time.	Off	-	Do not change default.
DEFAD	Default MOSFET area of drain	Resets the value for MOS drain diffusion area.	0	m <sup>2</sup>	Use default value unless you know how to specify a value from a MOS device datasheet.
DEFAS	Default MOSFET area of source	Resets the value for MOS source diffusion area.	0	m <sup>2</sup>	Use default value unless you know how to specify a value from a MOS device datasheet.
DEFL	Default MOSFET length	Resets the value for MOS channel length.	0.0001	μm	Use default value unless you know how to specify a value from a MOS device datasheet.
DEFW	Default MOSFET width	Resets the value for MOS channel width	0.0001	μm	Use default value unless you know how to specify a value from a MOS device datasheet.
TRYTOCOMPACT	Try compaction for LTRA lines	Applicable only to lossy transmission line component. When option turned on, Multisim tries to reduce data storage and memory usage needed for transient simulation of circuits containing lossy transmission lines.	Off	-	-
OLDLIMIT	Use SPICE2 MOSfet limiting		Off	-	

## 11.23.5 Advanced tab

Code	Option Name	Description	Default	Unit	Recommendation
AUTOPARTIAL	Use auto-partial computation for all models		Off	-	
BADMOS3	Use old mos3 model (discontinuous with respect to kappa)		Off	-	
KEEPOPINFO	Record operating point for each small-signal analysis	Retains the operating point information whether an AC, Distortion, or Pole-Zero analysis is run.	Off	-	Particularly useful if the circuit is large and you do not want to run a redundant ".OP" analysis.
MAXEVTITER	Maximum event iterations at analysis point		0		
MAXOPALTER	Maximum analog/event alternations in DCOP		0		
MINBREAK	Minimum time between breakpoints		0	s	
NOOPALTER	Do not do analog/event alternation in DCOP		Off	-	

# Chapter 12

## Postprocessor

This chapter explains how to use the **Postprocessor** to mathematically manipulate the results of simulation obtained through analyses in different ways.

To use the **Postprocessor**, you must have performed at least one analysis on your circuit. This chapter assumes that you are familiar with the analyses offered by Multisim 9, and the **Grapher** that displays analysis results. For details, see Chapter 11, “Analyses”.



Some of the features described in this chapter may not be available in your edition of Multisim 9. Such features have an icon in the column next to their description. Refer to the release notes for a list of the features in your edition.

The following are described in this chapter:

<b>Subject</b>	<b>Page No.</b>
<b>Introduction to the Postprocessor</b>	12-2
<b>Using the Postprocessor</b>	12-2
Basic Steps	12-2
Working with Pages, Traces, Graphs and Charts	12-8
<b>Postprocessor Variables</b>	12-9
<b>Available Postprocessor Functions</b>	12-10



## 12.1 Introduction to the Postprocessor



The **Postprocessor** allows you to manipulate the output from analyses performed on a circuit and plot the results on a graph or chart. The plotted results are referred to as “traces”. Types of mathematical operations that can be performed on analysis results include: arithmetic, trigonometric, exponential, logarithmic, complex, vector, logic, etc.

The following examples illustrate possible uses of the **Postprocessor**:

- Divide the output curve by the input curve obtained from a transient analysis, and observe the results.
- Multiply a voltage by a current to observe circuit power.
- Assess the differences caused by minor changes to your circuit. For example, run an analysis on a circuit, then change one condition of the circuit (such as changing the input voltage of the component’s value) and run the analysis again. Subtract one set of results from the other to show the effect of the circuit modification.

## 12.2 Using the Postprocessor

The **Postprocessor** calculates the results of equations and plots these results as “traces” on graphs and charts. To use the **Postprocessor**, you build the equations yourself by combining the variables from previous circuit analysis results with mathematical functions.

To build equations for the **Postprocessor**, you must have performed at least one analysis. When you perform an analysis on a circuit, the results appear in the **Grapher** and are stored for use by the **Postprocessor**. For information on performing analyses, see Chapter 11, “Analyses”.

**Note** Equations created in the **Postprocessor** will be saved with Multisim allowing them to be available in the **Postprocessor** the next time you open Multisim. Your expressions can be used with other analysis results as long as the expression variables are labeled the same.

### 12.2.1 Basic Steps

To construct an equation from which a trace will be plotted, you select variables and mathematical operators.

**Note** You must have simulated the circuit you wish to use with the postprocessor in the current Multisim session so that the current simulation results are available.

➤ To build an expression:



1. Click the **Postprocessor** button on the **Main** toolbar or select **Simulate/Postprocessor**. The **Postprocessor** dialog box appears.

These are the mathematical functions available for use in your expression.

This is the name of the circuit on which analyses have been performed in this session.

This is an analysis performed on this circuit.

These are the variables that resulted from the selected analysis.

This is where you will build your Postprocessor expression.

Expressions from earlier sessions may be here. To remove, highlight the expression and click Delete.

2. Click on the **Expression** tab. The **Select Simulation Results** section lists Multisim files and each analysis performed within the file. Each analysis is identified with a name followed by a code in brackets. That code will be used to identify the variables from that analysis when the trace is plotted. Click on the analysis name, the variables that resulted from that analysis appear in the **Variables** list. For more about the syntax of these variables, see “12.3 Postprocessor Variables” on page 12-9.
3. From the **Variables** list, select the variables you want to include in the equation being used to define the trace, and click **Copy Variable to Equation**. The variable appears in the **Expressions** section, prefixed with the code of the analysis from which it is drawn (unless the selected analysis is the default analysis — for details on using the default analysis, see “12.2.1.1 Using the Default Analysis” on page 12-7)

**Note** To filter the **Variables** list to show only certain variables, choose from the drop-down list of options to show:

- All
- Top level (variables only in subcircuits)
- Subcircuit
- Open pins
- Device parameters

Here is the equation you are building, which will be used to plot the trace.

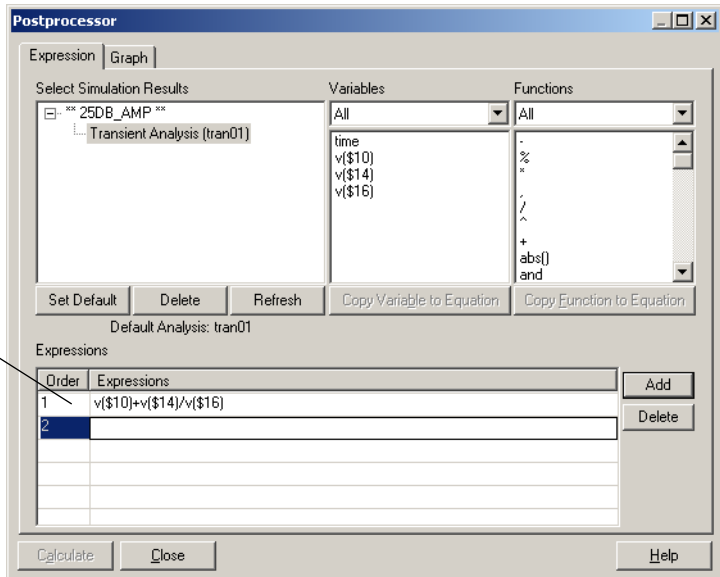

4. From the **Functions** list, select the mathematical function you want included in the equation for this trace, and click **Copy Function to Equation**. To filter the **Functions** list to show only certain mathematical functions, choose from the drop-down list of options. For details about the available functions, see “12.4 Available Postprocessor Functions” on page 12-10.

**Note** It is possible to manually type or modify a trace’s equation although you should exercise caution if doing so.

5. Continue to choose analyses, variables and functions until the equation is complete.
6. When complete, click **Add** or press ENTER to save your equation in the **Expressions** section.
7. Repeat above steps to add more equations.

- To view the results of the built equation.
1. Select the **Graph** tab. The following dialog box appears.

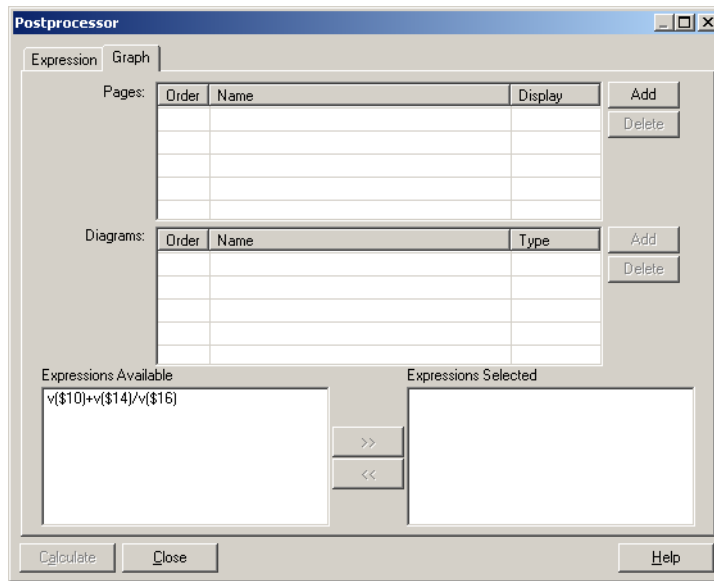

2. Click the **Add** button to the right of the **Pages** section. A default name will appear in the **Name** column of the **Pages** section. This is the name of the tab that will display the results in the **Grapher**. Change the default name if necessary.
3. Click the **Add** button to the right of the **Diagrams** section. A default name will appear in the **Name** column of the **Diagrams** section. This is the title of the diagram that will be displayed in the **Grapher**. Change the default name if necessary.
4. Click in the **Type** column of the **Diagram** section and choose either Graph or Chart from the drop-down list that appears.
5. In the **Expressions Available** section, select the equation you want to view.

- Click the >> button to move the equation to the **Expressions Selected** field. The dialog box will look like this:

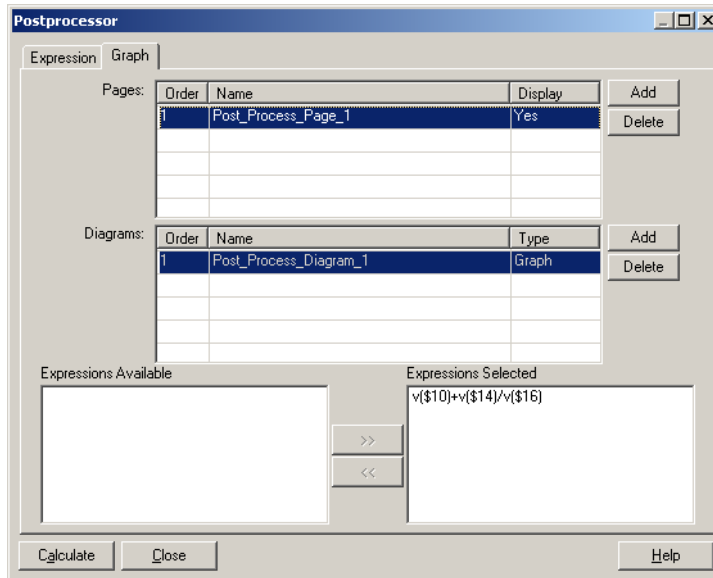

- Click the **Calculate** button to open the **Grapher** and view the results.

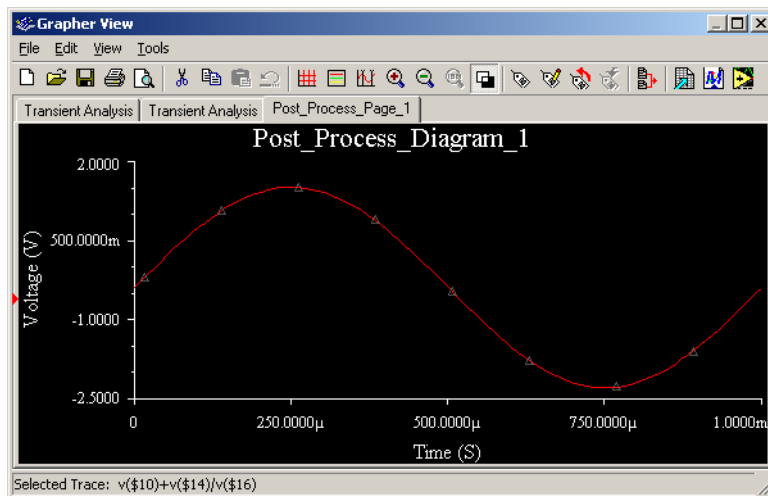

The results of the **Postprocessor** plotting the trace appear in the **Grapher**, in tabs with the names you specified, along with the results of the analyses previously performed. Results,

including errors, are also recorded in the **Simulation Error Log/Audit Trail**. For details, see “9.7 Simulation Error Log/Audit Trail” on page 9-25.

### 12.2.1.1 Using the Default Analysis

The equation you build using the **Postprocessor** contains variables that are prefixed with their analysis' code. To simplify the equation and the trace displayed on the graph, you can set one of the analyses to be the default analysis.

The **Select Simulation Results** list always contains one analysis defined as the default. The default is the analysis that, in the absence of any other indication, the **Postprocessor** uses for calculations. Variables from the default analysis do not have identifying prefixes in the equation or when the trace is plotted.

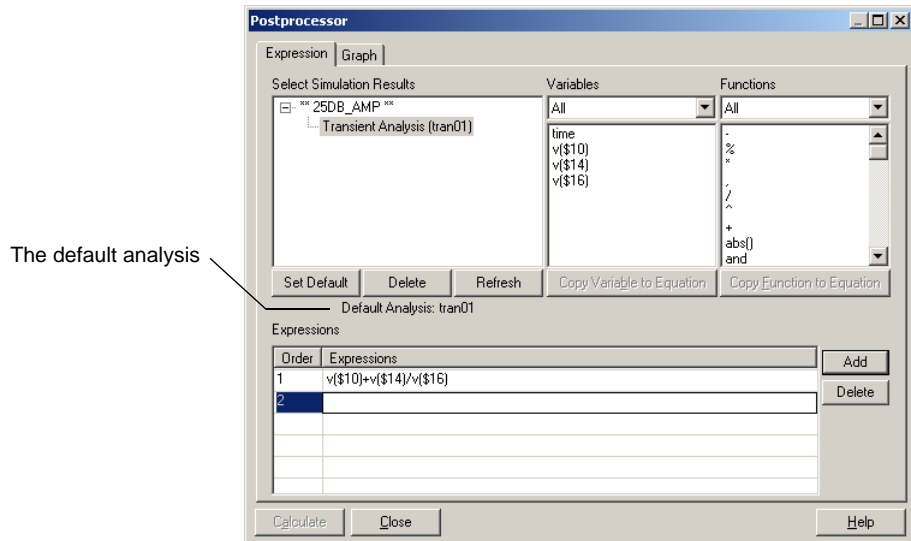

The default analysis is identified below the **Select Simulation Results** section in the **Expression** tab.

- To change the default analysis, click on the desired analysis in the **Select Simulation Results** section and click **Set Default**. The **Default Analysis** field displays your choice.

### 12.2.1.2 Creating Multiple Traces

- To add another trace to a **Grapher** page:
  1. Select the **Graph** tab from the **Postprocessor** dialog box.
  2. In the **Expressions Available** section, select another equation you want to view.
  3. Click the >> button to move the equation to the **Expressions Selected** field.
  4. Click the **Calculate** button to open the **Grapher** and view the results.

## 12.2.2 Working with Pages, Traces, Graphs and Charts

- To add another page (tab) to the **Grapher** to display traces:
  1. Select the **Graph** tab in the **Postprocessor** dialog box.
  2. Click the **Add** button in the **Pages** section. A default name will appear in the **Name** column under the first page name. Change the default name if necessary.
  3. Click the **Add** button in the **Diagrams** section. A default name will appear in the **Name** column under the first diagram name. Change the default name if necessary.
  4. Click in the **Type** column of the **Diagram** section and choose either Graph or Chart from the drop-down list that appears.
  5. In the **Expressions Available** section, select the equation you want to view.
  6. Click the >> button to move the equation to the **Expressions Selected** field.
  7. Click the **Calculate** button to open the **Grapher** and view the results.
- To change between a graph or chart:
  1. Select the **Graph** tab in the **Postprocessor** dialog box.
  2. Click in the **Type** column of the **Diagram** section and choose either Graph or Chart from the drop-down list that appears.

**Note** Each chart or graph appears on the page in the **Grapher** to which it has been assigned.
- To remove a trace:
  1. Select the **Graph** tab and highlight the expression to be removed in the **Expressions Selected** field.
  2. Click the << button to move the expression to the **Expressions Available** field.

- To delete a page, select it in the **Pages** section of the **Graph** tab and click the **Delete** button to the right of the **Pages** section.

## 12.3 Postprocessor Variables

The variables that appear in the **Analysis Variables** list of the **Postprocessor** are based on the selected analysis. They can include any or all of the following:

Variable	Description
v(#)	voltage in node, where # represents the node number
vv# #branch	branch current through voltage source "vv#" (vv# represents the voltage source name)
expr.x#	expression within subcircuit x#



## 12.4 Available Postprocessor Functions

The functions you can apply to the **Postprocessor** variables are:

Symbol	Type	Description
+	Algebraic	plus
-	Algebraic	minus
*	Algebraic	times
/	Algebraic	divided by
^	Algebraic	to the power of
%	Algebraic	percentage
,	Algebraic	complex $3,4 = 3 + j(4)$
abs()	Algebraic	absolute value
sqrt()	Algebraic	square root
sin()	Trigonometric	sine
cos()	Trigonometric	cosine
tan()	Trigonometric	tangent
atan()	Trigonometric	inverse tangent
gt	Relationship	greater than
lt	Relationship	less than
ge	Relationship	greater than or equal to
le	Relationship	less than or equal to
ne	Relationship	not equal to
eq	Relationship	equal to
and	Logic	and
or	Logic	or
not	Logic	not
db()	Exponential	$20 \log_{10}(\text{mag}(\text{vector}))$
log()	Exponential	logarithm (base 10)

Symbol	Type	Description
ln()	Exponential	natural logarithm (base 3)
exp()	Exponential	e to the vector power
j()	Complex	$i$ (sqrt(-1)) times vector
real()	Complex	real component of vector
imag()	Complex	imaginary part of vector
vi()	Complex	$vi(x) = \text{image}(v(x))$
vr()	Complex	$vr(x) = \text{real}(v(x))$
mag()	Vector	magnitude
ph()	Vector	phase
norm()	Vector	vector normalized to 1 (that is, the largest magnitude of any component is 1)
rnd()	Vector	random
mean()	Vector	results in a scalar (a length 1 vector) that is the mean of the elements of the vector
Vector( <i>number</i> )	Vector	results in a vector of length <i>number</i> , with elements 0, 1, ... <i>number</i> -1. If <i>number</i> is a vector than just the first element is taken, and if it isn't an image then the floor of the magnitude is used.
length()	Vector	length of vector
deriv()	Vector	derivative of vector — uses numeric differentiation by interpolating a polynomial and may not produce satisfactory results, particularly with iterated differentiation. Only calculates the derivative with respect to the real component of the vector's scale.
max()	Vector	maximum value from vector
min()	Vector	minimum value from vector
vm()	Vector	$vm(x) = \text{mag}(v(x))$
vp()	Vector	$vp(x) = \text{ph}(v(x))$
yes	Constant	yes
true	Constant	true

Symbol	Type	Description
no	Constant	no
false	Constant	false
pi	Constant	pi
e	Constant	natural logarithm base
c	Constant	speed of light in vacuum
i	Constant	square root of -1
kelvin	Constant	degrees kelvin
echarge	Constant	fundamental charge
boltz	Constant	Boltzman's constant
planck	Constant	Planck's constant

# Chapter 13

## Reports



This chapter details the various reports that are available in Multisim 9.

Some of the features described in this chapter may not be available in your edition of Multisim 9. Such features have an icon in the column next to their description. Refer to the release notes for a list of the features in your edition.

Refer to the sections noted below for detailed descriptions of each report's capabilities.

<b>Subject</b>	<b>Page No.</b>
<b>Bill of Materials</b> Using the BOM Report	13-2 13-3
<b>Component Detail Report</b> Using the Component Detail Report	13-5 13-5
<b>Netlist Report</b> Using the Netlist Report	13-6 13-7
<b>Schematic Statistics Report</b> Using the Schematic Statistics Report	13-8 13-8
<b>Spare Gates Report</b> Using the Spare Gates Report	13-9 13-10
<b>Model Data Report</b> Using the Model Data Report	13-11 13-11
<b>Cross Reference Report</b> Using the Cross Reference Report	13-12 13-12
<b>Variants Filter Dialog Box</b>	13-13

## 13.1 Bill of Materials



A Bill of Materials (BOM) lists the components used in your design and provides a summary of the components needed to manufacture the circuit board. You can also select which fields to view and print on your BOM.

The **Bill of Materials** report includes each component's:

- Quantity
- Description, including its type (for example, resistor) and value (for example, 5.1 kohm)
- RefDes
- Package or footprint.

Tool Buttons

Component Data

Quantity	Description	RefDes	Package
1	SEVEN_SEG_DECIMAL_COM_A_BLUE	U1	Generic\7SEG8DIP10A
2	74HC_4V, 74HC190N_4V	U2	Generic\N016
3	74LS, 74LS47N	U3	Generic\N016
4	RESISTOR, 2000hm_1%	R1	Generic\RES0.25
5	SWITCH, SPDT	J1, J2	Generic\SPDT
6	50K_LIN, 50K_LIN	R2	Generic\LIN_POT
7	RESISTOR, 1.0kOhm_5%	R3	Generic\RES0.25
8	OPAMP, 741	U4	Generic\DIP-8
9	CAP_ELECTROLIT, 1uF-POL	C1	Generic\ELK05R5
10	CAPACITOR, 10nF	C2	Generic\CAP3
11	CAP_ELECTROLIT, 100uF-POL	C3	Generic\ELK010R5
12	CONNECTORS, HDR1x4	J3	Generic\HDR1x4
13	LED_blue	LED1	Uliboard\LED9R2_5Vb

The **Bill of Materials** can also show all user fields and their values. For more on defining and completing user fields, see “8.10 Editing User Fields” on page 8-63.

**Note** Because a BOM is primarily intended to assist in procurement and manufacturing, it includes only “real” parts. Therefore, it excludes parts that are not real or able to be purchased, such as sources or virtual components. If desired, you may also view a list of the virtual components in a circuit.

## 13.1.1 Using the BOM Report

- To create a Bill of Materials (BOM) for your circuit:
  1. Have the desired circuit open in your workspace.
  2. Select **Reports/Bill of Materials**. The **Bill of Materials View** dialog box displays.

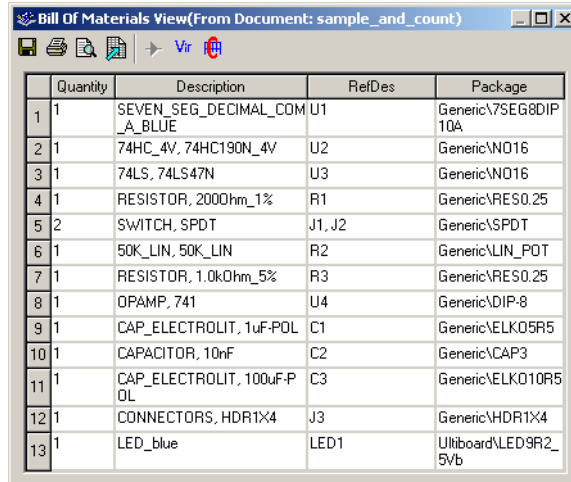

	Quantity	Description	RefDes	Package
1	1	SEVEN_SEG_DECIMAL_COM_A_BLUE	U1	Generic\7SEG8DIP10A
2	1	74HC_4V, 74HC190N_4V	U2	Generic\N016
3	1	74LS, 74LS47N	U3	Generic\N016
4	1	RESISTOR, 2000hm_1%	R1	Generic\RES0.25
5	2	SWITCH, SPDT	J1, J2	Generic\SPDT
6	1	50K_LIN, 50K_LIN	R2	Generic\LIN_POT
7	1	RESISTOR, 1.0kOhm_5%	R3	Generic\RES0.25
8	1	OPAMP, 741	U4	Generic\DIP-8
9	1	CAP_ELECTROLIT, 1uF-POL	C1	Generic\ELK05R5
10	1	CAPACITOR, 10nF	C2	Generic\CAP3
11	1	CAP_ELECTROLIT, 100uF-POL	C3	Generic\ELK010R5
12	1	CONNECTORS, HDR1x4	J3	Generic\HDR1x4
13	1	LED_blue	LED1	Uliboard\LED9R2_5Vb

**Note** If there are multiple variants in the circuit, the **Variants Filter** dialog box will display before the report dialog. For details, see “13.8 Variants Filter Dialog Box” on page 13-13.

3. Optionally, adjust the displayed information using the buttons detailed below

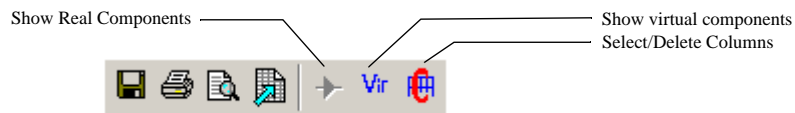

- **Select/Delete Columns** button — click to display the **Select Columns** dialog box. Select or deselect the columns you wish to view. Note that the buttons on the left side of the

toolbar are greyed-out (disabled) when this view is selected.

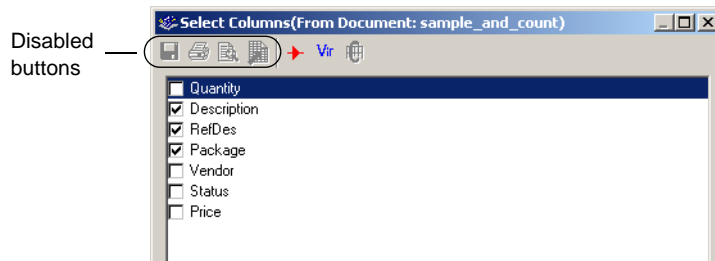

- **Show Real Components** button — click to return to the **Bill of Materials View** dialog box from either the **Select Columns** dialog box or the **Virtual Components View** dialog box.
- **Show Virtual Components** button — click to display the **Virtual Components View** dialog box.

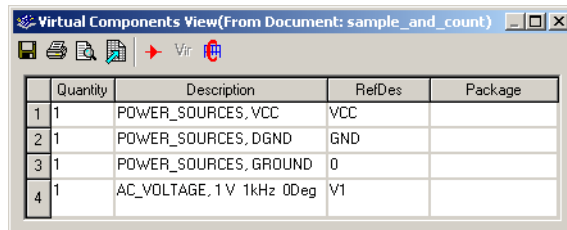

4. Optionally, click on a column (Quantity, Description, etc.) to sort the data on the dialog box in ascending order by that column. Click again to sort by descending order.
5. Use the buttons detailed below as required to produce your report.



- **Save to a Text File** — click to save the data on the dialog box (from either the Bill of Materials View or Virtual Components View) to a text file. A standard Windows save dialog box appears. Choose the desired filepath and click **Save**.
- **Send to a Printer** — click to display a standard Windows print dialog box. Choose the desired print options and click **OK**.
- **Print Preview** — click to display a Print Preview dialog box.
- **To MS Excel App** — click to open a Microsoft<sup>®</sup> Excel spreadsheet with the data from the dialog box displayed. (You must have Excel installed to use this function).

## 13.2 Component Detail Report

You can produce a **Component Detail Report** showing all information stored in the Multisim database for a particular component.

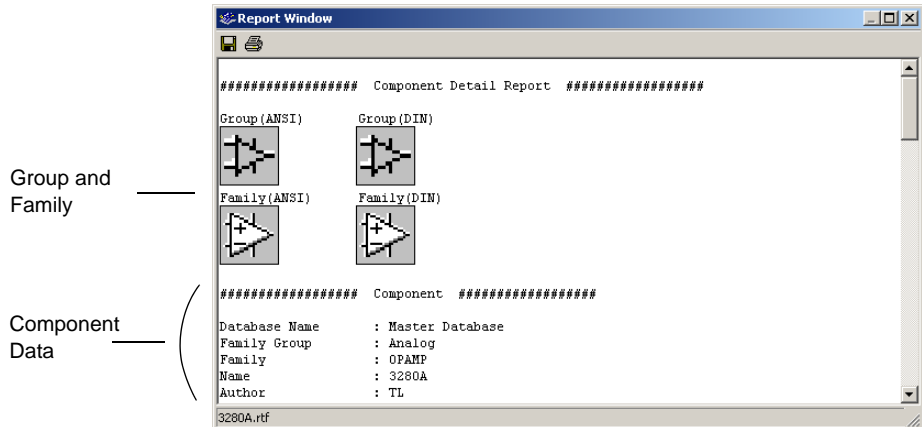

### 13.2.1 Using the Component Detail Report

- To produce a **Component Detail Report** showing detailed information about a specific component:
  1. Select **Reports/Component Detail Report**. The **Select a Component to Print** dialog box displays.
  2. Select a specific **Database, Group, Family** and **Component** in the dialog box.
  3. Click the **Detail Report** button. The **Component Detail Report** dialog box displays.

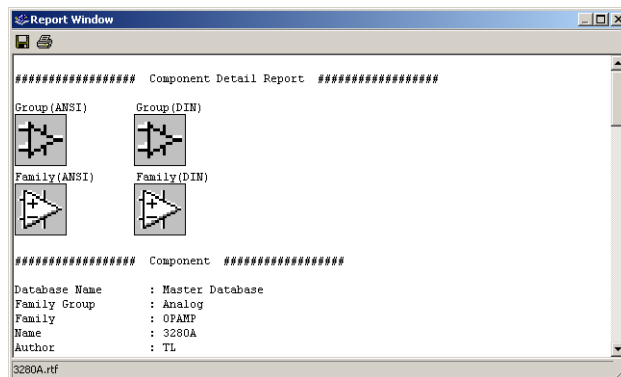



4. Scroll through the information as necessary using the scrollbar on the right of the dialog box.
5. Use the buttons on the dialog box as required:
  - **Save** — click to save the data to a text file. A standard Windows save dialog box appears. Choose the desired filepath and click **Save**.
  - **Print** — click to print the information in the report. A standard Windows print dialog box appears. Choose the desired print options and click **OK**.

**Note** This report can also be accessed via the **Detail Report** button in the **Components** tab of the **Database Manager** dialog box.

## 13.3 Netlist Report

The **Netlist Report** provides the following circuit connectivity information for each component:

- Net (net name)
- Page (filename)
- Pin (logical pin name).

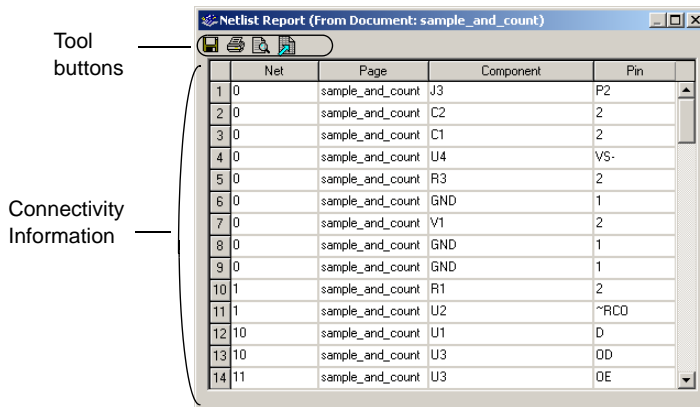

## 13.3.1 Using the Netlist Report

- To produce a netlist:
1. Have the desired circuit open in your workspace.
  2. Select **Reports/Netlist Report**. The **Netlist Report** dialog box displays.

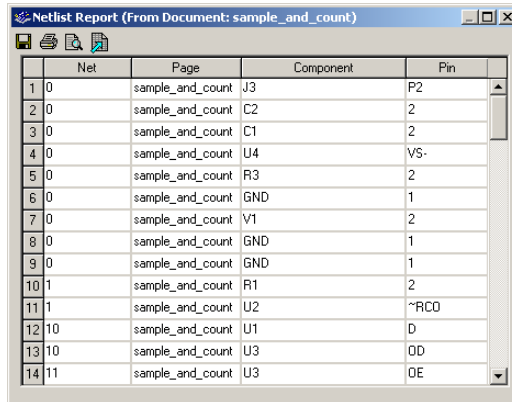

	Net	Page	Component	Pin
1	0	sample_and_count	J3	P2
2	0	sample_and_count	C2	2
3	0	sample_and_count	C1	2
4	0	sample_and_count	U4	VS-
5	0	sample_and_count	R3	2
6	0	sample_and_count	GND	1
7	0	sample_and_count	V1	2
8	0	sample_and_count	GND	1
9	0	sample_and_count	GND	1
10	1	sample_and_count	R1	2
11	1	sample_and_count	U2	~RCD
12	10	sample_and_count	U1	0
13	10	sample_and_count	U3	00
14	11	sample_and_count	U3	0E

**Note** If there are multiple variants in the circuit, the **Variants Filter** dialog box will display before the report dialog. For details, see “13.8 Variants Filter Dialog Box” on page 13-13.

3. Optionally, click on a column (Net, Page, etc.) to sort the data on the dialog box in ascending order by that column. Click again to sort by descending order.
  - **Net** — the net in which the component is found.
  - **Page** — page (filename) where the component is located or the root page if the component is part of a subcircuit, hierarchical block or multi-page.
  - **Component** — component’s RefDes and subcircuit, hierarchical block or multi-page name.
  - **Pin** — component’s logical pin name.
4. Use the buttons detailed below as required to output your report.



- **Save to a Text File** — click to save the data on the dialog box to a standard text file. A standard Windows save dialog box appears. Choose the desired filepath and click **Save**.
- **Send to a Printer** — click to display a standard Windows print dialog box. Choose the desired print options and click **OK**.
- **Print Preview** — click to display a **Print Preview** dialog box.
- **To MS Excel App** — click to open a Microsoft<sup>®</sup> Excel spreadsheet with the data from the dialog box displayed. (You must have Excel installed to use this function).

## 13.4 Schematic Statistics Report



The **Schematic Statistics Report** lists the quantity of the following in your circuit:

- Components — total number of components. (Real components + virtual components).
- Real components — components that can be purchased.
- Virtual components — components that cannot be purchased.
- Gates — total number of gates used in the design.
- Nets — total number of connections between pins.
- Pins in nets.
- Unconnected pins.
- Total pins — pins in nets + unconnected pins.
- Pages.
- Hierarchical blocks — total number of hierarchical blocks, unique or otherwise. Instances of hierarchical blocks equals the number of copies of the same hierarchical block.
- Unique hierarchical blocks — total number of unique hierarchical blocks.
- Subcircuits — total number of subcircuits, unique or otherwise.
- Unique subcircuits.

	Name	Quantity
1	Number of components	35
2	Number of real components	18
3	Number of virtual components	17
4	Number of gates	29
5	Number of nets	15
6	Number of pins in nets	64
7	Number of unconnected pins	6
8	Total number of pins	70
9	Number of pages	1
10	Number of hierarchical block instances	0
11	Number of unique hierarchical blocks	0
12	Number of subcircuit instances	1
13	Number of unique subcircuits	1

### 13.4.1 Using the Schematic Statistics Report

- To produce a schematic statistics report:
  1. Have the desired circuit open in your workspace.
  2. Select **Reports/Schematic Statistics**. The **Schematic Statistics Report** dialog box displays.

**Note** If there are multiple variants in the circuit, the **Variants Filter** dialog box will display before the report dialog. For details, see “13.8 Variants Filter Dialog Box” on page 13-13.

- Optionally, click on a column (**Name, Quantity**) to sort the data on the dialog box in ascending order by that column. Click again to sort by descending order.
- Use the buttons detailed below as required to produce your report.



- **Save to a Text File** — click to save the data on the dialog box to a standard text file. A standard Windows save dialog box appears. Choose the desired filepath and click **Save**.
- **Send to a Printer** — click to display a standard Windows print dialog box. Choose the desired print options and click **OK**.
- **Print Preview** — click to display a Print Preview dialog box.
- **To MS Excel App** — click to open a Microsoft<sup>®</sup> Excel spreadsheet with the data from the dialog box displayed. (You must have Excel installed to use this function).

## 13.5 Spare Gates Report



The **Spare Gates Report** lists the unused sections of multi-section components in a circuit. By running the **Spare Gates Report**, you can quickly see which components still have available gates.

For example, in a QUAD 2-INPUT NAND you may not have used all four of the available NAND gates (sections).

	Component	Part	Section(s) available
1	U1	7400N	C, D
2	U2	74S08D	D

## 13.5.1 Using the Spare Gates Report

➤ To produce a **Spare Gates Report**:

1. Have the desired circuit open in your workspace.
2. Select **Reports/Spare Gates Report**. The **Spare Gates Report** dialog box displays.

**Note** If there are multiple variants in the circuit, the **Variants Filter** dialog box will display before the report dialog. For details, see “13.8 Variants Filter Dialog Box” on page 13-13.

3. Optionally, click on a column to sort the data on the dialog box in ascending order by that column. Click again to sort by descending order.

The columns contain the following information:

- **Component** — the RefDes of the component that contains the spare gates.
- **Part** — the type of component.
- **Section(s) available** — the sections in the component that are still unplaced. Each section corresponds to one gate.

4. Use the buttons detailed below as required to produce your report.



- **Save to a Text File** — click to save the data on the dialog box to a standard text file. A standard Windows save dialog box appears. Choose the desired filepath and click **Save**.
- **Send to a Printer** — click to display a standard Windows print dialog box. Choose the desired print options and click **OK**.
- **Print Preview** — click to display a Print Preview dialog box.
- **To MS Excel App** — click to open a Microsoft<sup>®</sup> Excel spreadsheet with the data from the dialog box displayed. (You must have Excel installed to use this function).

## 13.6 Model Data Report

The **Model Data Report** gives you the model information for a selected component.

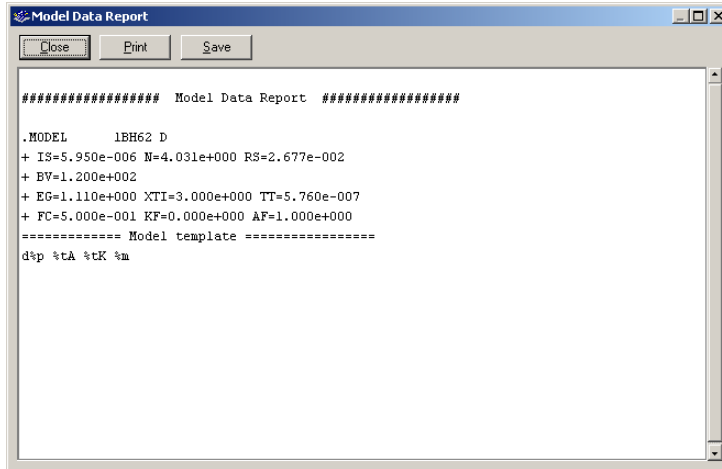

### 13.6.1 Using the Model Data Report

- To generate a **Model Data Report**:
  1. Have the desired circuit open in your workspace.
  2. Select **Report/Component Detail Report** to display the **Select a Component to Print** dialog box.
  3. Use the **Database**, **Group**, **Family** and **Component** lists to navigate to, and highlight, the component for which you wish to generate the report.
  4. Click on **Model**. The **Model Data Report** displays, where you can view the model data, print the report, or save the data to a text file.
  5. Click on **Close** to close the dialog box and return to your circuit file.

## 13.7 Cross Reference Report

The **Cross Reference Report** provides a detailed list of all components in the active circuit.

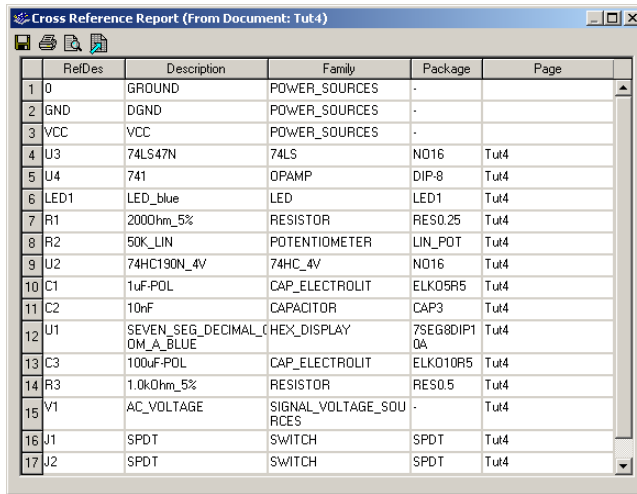

	RefDes	Description	Family	Package	Page
1	0	GROUND	POWER_SOURCES	.	
2	GND	DGND	POWER_SOURCES	.	
3	VCC	VCC	POWER_SOURCES	.	
4	U3	74LS47N	74LS	ND16	Tut4
5	U4	741	OPAMP	DIP-8	Tut4
6	LED1	LED_blue	LED	LED1	Tut4
7	R1	2000hm_5%	RESISTOR	RES0.25	Tut4
8	R2	50K_LIN	POTENTIOMETER	LIN_POT	Tut4
9	U2	74HC190N_4V	74HC_4V	ND16	Tut4
10	C1	1uF-POL	CAP_ELECTROLIT	ELK05R5	Tut4
11	C2	10nF	CAPACITOR	CAP3	Tut4
12	U1	SEVEN_SEG_DECIMAL_HEX_DISPLAY DM_A_BLUE	CHEX_DISPLAY	7SEG8DIP10A	Tut4
13	C3	100uF-POL	CAP_ELECTROLIT	ELK010R5	Tut4
14	R3	1.0k0hm_5%	RESISTOR	RES0.5	Tut4
15	V1	AC_VOLTAGE	SIGNAL_VOLTAGE_SOURCES	.	Tut4
16	J1	SPDT	SWITCH	SPDT	Tut4
17	J2	SPDT	SWITCH	SPDT	Tut4

### 13.7.1 Using the Cross Reference Report

➤ To produce a **Cross Reference** report:

1. Have the desired circuit open in your workspace.
2. Select **Reports/Cross Reference Report**. The **Cross Reference Report** dialog box displays.

**Note** If there are multiple variants in the circuit, the **Variants Filter** dialog box will display before the report dialog. For details, see “13.8 Variants Filter Dialog Box” on page 13-13.

3. Optionally, click on a column to sort the data on the dialog box in ascending order by that column. Click again to sort by descending order.
4. Use the buttons detailed below as required to produce your report.



- **Save to a Text File** — click to save the data on the dialog box to a standard text file. A standard Windows save dialog box appears. Choose the desired filepath and click **Save**.
- **Send to a Printer** — click to display a standard Windows print dialog box. Choose the

desired print options and click **OK**.

- **Print Preview** — click to display a Print Preview dialog box.
- **To MS Excel App** — click to open a Microsoft® Excel spreadsheet with the data from the dialog box displayed. (You must have Excel installed to use this function).

## 13.8 Variants Filter Dialog Box



When there is more than one variant present in a circuit, the **Variants Filter** dialog box will display when you run the following reports:

- **Bill of Materials** — for details on this report, see “13.1 Bill of Materials” on page 13-2.
- **Netlist Report** — for details on this report, see “13.3 Netlist Report” on page 13-6.
- **Schematic Statistics** — for details on this report, see “13.4 Schematic Statistics Report” on page 13-8
- **Spare Gates Report** — for details on this report, see “13.5 Spare Gates Report” on page 13-9
- **Cross Reference Report** — for details, see “13.7 Cross Reference Report” on page 13-12.

If you select one of the above reports in a circuit that has multiple variants, the following dialog box appears.

Variant Name	Status
EU	Included
NA	Included

Include All Variants

OK Cancel

Include or Exclude variant from the report using the drop-down list in this field.

Enable checkbox to include all variants in the report.



# Chapter 14

## Transfer/Communication

This chapter explains how to use Multisim to transfer either circuit schematics themselves (in whole or in part), or the results of simulation.



Some of the features described in this chapter may not be available in your edition of Multisim 9. Such features have an icon in the column next to their description. Refer to the release notes for a list of the features in your edition.

The following are described in this chapter.

<b>Subject</b>	<b>Page No.</b>
<b>Introduction to Transfer/Communication</b>	14-2
<b>Exporting to PCB layout</b>	14-2
Transferring from Multisim to Ultiboard for PCB Layout	14-3
Transferring to Other PCB Layout Packages	14-4
Multisection Components	14-4
<b>Forward Annotation</b>	14-4
<b>Back Annotation</b>	14-5
<b>Exporting Simulation Results</b>	14-5
Exporting to MathCAD	14-5
Exporting to Excel	14-6
Exporting to LabView	14-7
<b>Exporting a Netlist</b>	14-7
<b>Importing Files with Other Formats</b>	14-8
Importing a SPICE or PSPICE Netlist	14-9
<b>Internet Design Sharing</b>	14-10

## 14.1 Introduction to Transfer/Communication

Multisim makes it easy to transfer schematic and simulation data to and from other programs for further processing. Multisim can combine schematic information and simulation data for transfer together. For example, when transferring your schematic to perform a PCB layout, Multisim can include optimized trace width information (calculated using the Trace Width Analysis during simulation).

## 14.2 Exporting to PCB layout

Multisim provides features that integrate with many PCB layout programs, and it is particularly well-integrated with its sister product, Ultiboard.

In Multisim you define PCB Layers, and then constrain nets to be routed on these layers. You can also indicate for specific nets the desired, min and max trace widths, min and max trace lengths, minimum distances to other traces, pads, vias, and so on. As well, Multisim will keep track of power and ground nets, and constrain them to be routed only on layers of the appropriate type.

Layer	Routable	Type
Top	Yes	Signal
Inner1	Yes	Power
Inner2	No	Signal
Inner3	No	Signal
Inner4	Yes	Ground
Bottom	Yes	Signal

Net	Color	Trace Width Min	Routing Layer
3	Custom	1	Top
0	Default	1	Top
1	Custom	100	Top
2	Default	100	Top

When the schematic has been prepared, the design will be flattened and consolidated, and transferred to Ultiboard for board layout. In Ultiboard you design the board shape and size, place the components on the board, and route the nets as copper traces on as many layers as you like, placing vias to connect traces between layers. Ultiroute, an add-in product to Ultiboard, is used to both place parts and to route traces automatically. Periodic animations of the layout in intermediate autorouting stages help you to gauge Ultiroute progress.

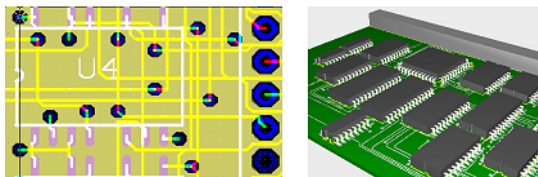

The Multisim/Ultiboard libraries also contain full 3D mechanical CAD information for boards and parts. A 3D view of the board enables you to quickly preview the mechanical properties of the board. A small mechanical CAD package in Ultiboard allows for quick

casing designs. For larger jobs, the 3D board information can be exported to popular mechanical CAD packages.

In order to enable better routing, Ultiboard and/or Ultiroute may wish to swap pins of components (e.g., swap the two inputs of an AND gate), or may wish to swap sections within a component (e.g., use a different gate in a QUAD AND chip). Multisim provides Ultiboard with all the information required to do this.

Changes made in Ultiboard (either automatic ones or manual ones) can be "back annotated" to Multisim. For example, if a component is renamed, swapped with one another, pins are swapped, parts are deleted, and so on. The changes will be made into the schematic in Multisim as well. Likewise, subsequent changes to the schematic in Multisim can be "forward annotated" to Ultiboard, in order that progress to date on a board design is not lost if a small change in the schematic is made. Both programs have a feature called "cross probing", which enables parts or nets in one application to be quickly found in the other.

Taken together, Multisim (with MultiVHDL), and Ultiboard (with Ultiroute) provide a complete end-to-end solution for circuit and PCB design.

## 14.2.1 Transferring from Multisim to Ultiboard for PCB Layout

One of the most common applications to which you may want to transfer data is a PCB layout program. Ultiboard, also from Electronics Workbench, is one of the industry's leading PCB layout tools and offers many advantages over other layout programs, including trace width optimization synchronized with Multisim simulation.

- To transfer a circuit design from Multisim to Ultiboard, in order to perform a PCB layout:
  1. Select **Transfer/Transfer to Ultiboard**. A standard Windows **Save As** dialog box appears.
  2. Specify the name and location of the file to be created and click **Save**. Multisim creates files that can then be loaded into Ultiboard.
  3. Load the created files into Ultiboard, following the instructions in the *Ultiboard User Guide*.

## 14.2.2 Transferring to Other PCB Layout Packages

If you are using a PCB layout package by a vendor other than Electronics Workbench, you can create files in the necessary formats for transfer to the following third party layout packages:

- Eagle
  - Layo 1
  - OrCAD
  - PADS
  - P-CAD
  - Protel
  - Tango
  - Ultimate
- To transfer the circuit design to a third party layout package:
1. Select **Transfer/Transfer to other PCB Layout**. A standard Windows **Save As** dialog box appears.
  2. Navigate to the desired folder, enter a file name, choose the desired manufacturer from the drop-down list and click **Save**. Multisim creates a file of the appropriate format that can then be loaded into the layout package of your choice.

## 14.2.3 Multisection Components

Multisection components in different subcircuits, hierarchical blocks or multipages of the same design may be placed on the same IC even though they may have different Reference Designators.

## 14.3 Forward Annotation

Forward Annotation lets you annotate changes made to a schematic file in Multisim to its existing Ultiboard file.

- To forward annotate changes to Ultiboard:
1. Select **Transfer/Forward Annotate to Ultiboard** or click on the **Forward Annotate** button in the **Standard** toolbar. A standard **Save As** dialog box appears.
  2. Enter the desired filename and filepath and click **Save**. This file can be opened in Ultiboard and used to update the circuit information.



## 14.4 Back Annotation

Back Annotation allows you to incorporate changes to a circuit that were made in Ultiboard (for example, deleted components) into the corresponding Multisim circuit file.

- To back annotate changes made in Ultiboard:



1. Select **Transfer/Back Annotate from Ultiboard** or click on the **Back Annotate** button in the **Standard** toolbar. A standard **Open** dialog box appears.
2. Select the desired **.log** file and click **Open**. The **Annotation Log** dialog box appears.
3. Select the changes that you wish to back annotate to your Multisim file and click **OK**.

**Note** The circuit file must be open before you use this command.

**Note** If a changed part is in a hierarchical block or a subcircuit with multiple instances, changes will be ignored.

## 14.5 Exporting Simulation Results

### 14.5.1 Exporting to MathCAD

You can export the results of your simulation to MathCAD, allowing you to perform sophisticated mathematical operations on your data.

**Note** This function is only available if you have MathCAD installed on your computer.

- To export the simulation results to a MathCAD session:

1. Select **View/Grapher**. The **Grapher** appears, showing the results of your simulation and/or analysis.



2. Click the **Transfer to MathCAD** button. The **Select Traces** dialog box appears.

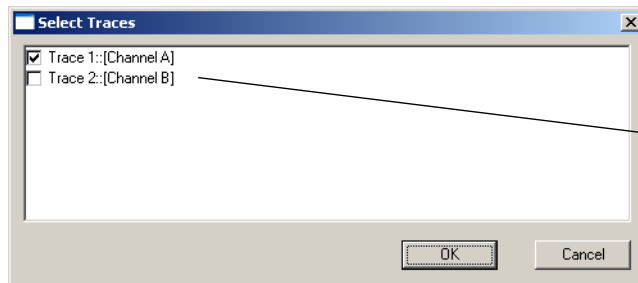

The contents of this dialog box change depending on the traces that are found in the tab you have selected in the Grapher.

3. Use the checkboxes to select the traces you wish to export to MathCAD and click **OK**.

**Note** If you place the cursors on the graph (via the **Show/Hide Cursors** button), the output data will be limited to the data that is located between the two cursors.

4. A new MathCAD session is started.

**Note** MathCAD will shut down when Multisim shuts down.

## 14.5.2 Exporting to Excel

You can export your simulation results to Excel, allowing you to use the data for further processing in a spreadsheet.

**Note** This function is only available if you have Excel installed on your computer.

➤ To export the simulation results to an Excel spreadsheet:

1. **Select View/Grapher. The Grapher** appears, showing the results of your simulation and/or analysis.



2. Click the **Transfer to Excel** button. The **Select Traces** dialog box appears.

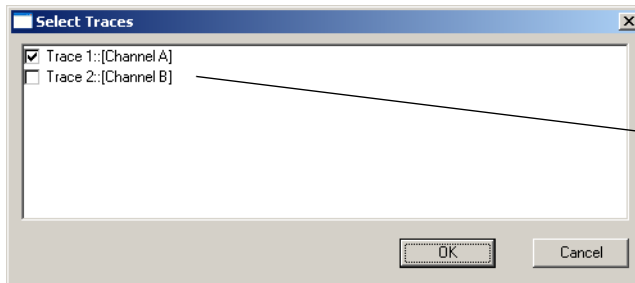

The contents of this dialog box change depending on the traces that are found in the tab you have selected in the Grapher.

3. Use the checkboxes to select the traces you wish to export to Excel and click **OK**.

**Note** If you place the cursors on the graph (via the **Show/Hide Cursors** button), the output data will be limited to the data that is located between the two cursors.

4. A new Excel spreadsheet is created, with data from the x coordinates in column one and data from the y coordinates in column two.

5. If desired, save the Excel spreadsheet.

## 14.5.3 Exporting to LabView

You can export the results of your simulation to LabView, allowing you to compare actual circuit output with simulated output and achieve a wider range of learning objectives and lab applications than is currently possible.

**Note** This function is only available if you have LabView installed on your computer.

- To export the simulation results to a LabView session:
  1. Select **View/Grapher**. The **Grapher** appears, showing the results of your simulation and/or analysis.
  2. Click the **Transfer to LabView** button. The **Select Traces** dialog box appears.

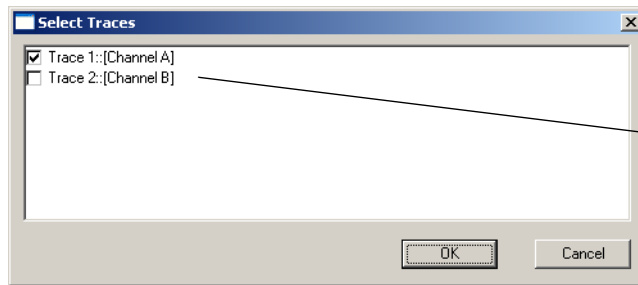

The contents of this dialog box change depending on the traces that are found in the tab you have selected in the Grapher.

3. Use the checkboxes to select the traces you wish to export to LabView and click **OK**.

**Note** If you place the cursors on the graph (via the **Show/Hide Cursors** button), the output data will be limited to the data that is located between the two cursors.

4. A new LabView session is started.

## 14.6 Exporting a Netlist

You can export a netlist for your circuit.

- To export a netlist:
  1. Select **Transfer/Export Netlist**. A standard Windows **Save As** dialog box appears. Select the filepath and filetype, enter the filename and click **Save**. The netlist is saved.

## 14.7 Importing Files with Other Formats

Files with the following formats can be opened with Multisim 9:

- Multisim 7 and Multicap 7 files — these have a .ms7 extension.
- Multisim 8 and Multicap 8 files — these have a .ms8 extension.
- Multisim 9 and Multicap 9 files — these have a .ms9 extension.
- Multisim files — these have a .msm extension.
- Electronics Workbench v5 files — these have a .ewb extension.
- Ulticap schematic files — these have a .utsch extension.
- OrCad schematic files — these have a .dsn extension.
- SPICE netlist files — these have a .cir extension.

**Note** When opening files from earlier versions of Electronics Workbench, Multisim or Multicap, Reference Designators may be renamed to ensure that all instances are unique.

- To open a file of any of the above-listed types except Ulticap:
  1. Select **File/Open**. A standard **Open** dialog box displays.
  2. Select the desired file type from the **Files of Type** drop-down list.
  3. Highlight the desired file and click **Open**. The file is opened in Multisim.
- To open a Ulticap schematic file:
  1. Select **File/Open**. A standard **Open** dialog box displays.
  2. Select the desired file type from the **Files of Type** drop-down list.
  3. Highlight the desired file and click **Open**. The following dialog displays:

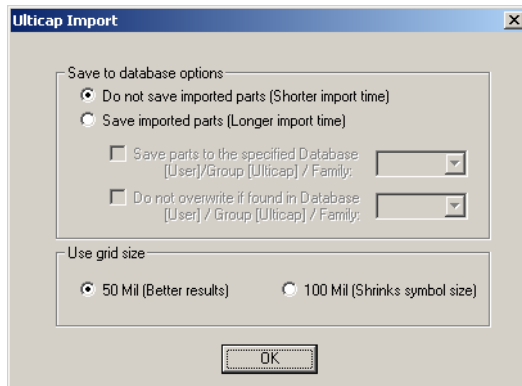



4. Select the desired options in the **Save to Database Options** box:
  - **Do not save imported parts** — imports the Ulticap parts without saving them to any of the Multisim databases.
  - **Save imported parts** — saves the imported Ulticap parts to the selected Multisim database.
5. In the **Use Grid Size** box, select one of:
  - **50 Mil** — places the Ulticap parts and the connected wires on a 50 mil grid. This will result in fewer importation errors, but some parts may appear quite large.
  - **100 Mil** — places the Ulticap parts and the connected wires on a 100 mil grid. Symbols will be smaller in size, but more importation errors may occur after the file is imported, as shown below:

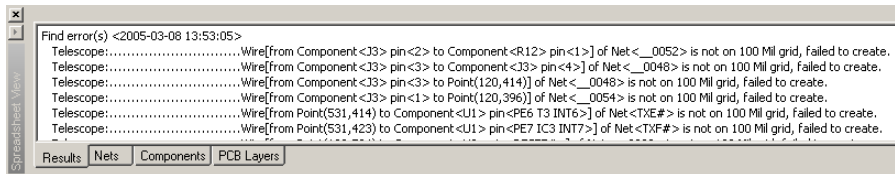

**Tip** Double-click on an error to highlight and zoom to it on the workspace.

6. Click **OK** to import the file. The following dialog displays duration importation of the Ulticap file. If desired, click **Abort** to cancel.

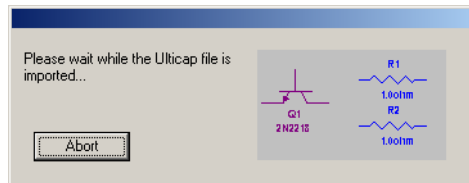

## 14.7.1 Importing a SPICE or PSPICE Netlist

In addition to the above method there is a second method for importing SPICE or PSpice netlists. The **source** command, under the **Simulate/XSPICE Command Line Interface** menu, is available for advanced users who need the flexibility offered from the command line. With this method, models and commands in the netlist file are interpreted, without substitution, by the simulation engine as they are represented in the netlist.

- To import a SPICE or PSPICE netlist from the command line:
1. Select **Simulate/XSPICE Command Line Interface**.
  2. Enter the **source** command along with the file name as shown below. This will load the netlist along with the models and connectivity information into memory. You will not see the circuit on the workspace but you can continue to execute other commands, such as **tran**, and display the results on the grapher with the **plot** command.

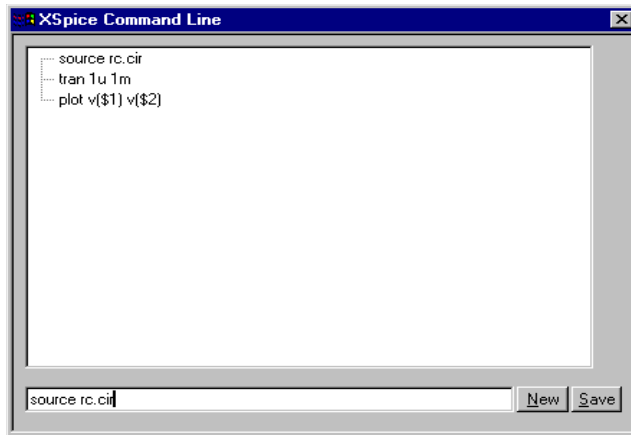

## 14.8 Internet Design Sharing

Multisim's **Internet Design Sharing** module allows you to share your designs with other Multisim users, and to control the PC of other users.

This module offers a way to share designs within a workgroup or department, allowing multiple people to work on a design at the same time and see the changes made to the circuit by others. Electronics Workbench's support department can also use this module to run Multisim on your PC, helping them diagnose any problems you might be encountering.

To use Multisim's **Internet Design Sharing** capability, you must have access to a network or the Internet, and have the free Microsoft application Netmeeting installed. To install a copy of this product, go to <http://www.microsoft.com/netmeeting>.

Once you have established a connection with another user, you can:

- send text messages back and forth (in a "chat" mode)
- see and/or talk to the user (if you have the necessary software and hardware to support audio/video links)
- use an electronic whiteboard to present ideas to other users
- send circuit files to other users

- let other users (including Electronics Workbench support personnel) control Multisim on your machine so you can work together
  - control other Multisim users' machines, so you can show them the changes you are making to a circuit.
- To use the **Internet Design Sharing** module:
1. Select **Tools/Internet/Design Sharing**.
  2. Follow the onscreen prompts to launch your Netmeeting session.

# Chapter 15

## RF

This chapter contains descriptions of the elements (components, model makers, instruments, analyses) of Multisim 9's RF Design module, as well as a tutorial demonstrating their use and some specific examples of RF functionality.



Some of the features described in this chapter may not be available in your edition of Multisim 9. Such features have an icon in the column next to their description. Refer to the release notes for a list of the features in your edition.

The following are described in this chapter.

<b>Subject</b>	<b>Page No.</b>
<b>Introduction to the Multisim RF Module</b>	15-2
<b>Components</b>	15-2
About RF Components	15-2
Multisim's RF Components	15-3
Theoretical Explanation of the RF Models	15-4
<b>RF Instruments</b>	15-9
Spectrum Analyzer	15-9
Network Analyzer	15-15
<b>RF Analyses</b>	15-18
RF Characterizer Analysis	15-18
Matching Network Analysis	15-20
Noise Figure Analysis	15-25
<b>RF Model Makers</b>	15-31
Waveguide	15-31
Microstrip Line	15-32
Open End Microstrip Line	15-33
RF Spiral Inductor	15-34
Strip Line Model	15-35
Stripline Bend	15-36
Lossy Line	15-37
Interdigital Capacitor	15-38

Subject	Page No.
<b>Tutorial: Designing RF Circuits</b>	15-39
Selecting Type of RF Amplifier	15-40
Selecting an RF Transistor	15-40
Selecting a DC-operating Point	15-41
Selecting the Biasing Network	15-41

## 15.1 Introduction to the Multisim RF Module



The Multisim RF module is intended to provide fundamental RF circuit design features needed by engineers to design, analyze and simulate RF circuits.

The Multisim RF module is made up of the following:

- RF-specific components, including customized RF SPICE models
- model makers for creating your own RF models
- two RF-specific instruments (Spectrum Analyzer and Network Analyzer)
- several RF-specific analyses (circuit characterizer, matching network cells, noise figure).

Elements of the RF Design module are fully integrated into Multisim. That is, the instruments, analyses and components are installed in the same places and invoked in the same way as all other instruments, analyses and components. You will not see a separate access to the RF Design Module in Multisim's interface. Instead, for example, the RF components have their own group which is accessed via the **RF** button on the **Component** toolbar and the RF instruments are accessed through the **Instruments** toolbar.

## 15.2 Components

### 15.2.1 About RF Components

Components in the electronics field fall into two categories — “lumped” components and “distributed” components. Lumped components are smaller than the wavelength, where:

$$\lambda = \frac{c}{f}$$

In these cases, the wavelength of the voltages and currents at which they are operating is significantly larger than the components themselves. Ohm's Law, in this case, is valid. For example, a 1/4 Watt resistor is about 0.270 inch long and 0.090 inch in diameter.

RF components, on the other hand, are most often “distributed elements”, where the phase of a voltage or current changes significantly over the physical extent of the device, because the device dimensions are similar to, in some cases even larger than, the wavelength. Standard circuit theory is therefore not always applicable to circuits that are working at a few MHz to above 1 GHz.

The usual models for lumped components are often not valid in the RF world. For example, a capacitor can behave like an inductor or an inductor can behave like a capacitor at high frequencies.

RF components exhibit parasitic effects, and have models different from those used in low frequencies. Connections between two nodes at high frequencies would exhibit different behavior from those at low frequencies, and are modeled using capacitances and inductances. These connections behave as transmission lines when implemented on a Printed Circuit Board (PCB). The board itself becomes part of the circuit, interfering with the normal circuit function. This is why low frequency circuit simulation EDA tools can become unreliable at higher frequencies.

Standard RF components include capacitors, inductors, toroids, ferrite beads, couplers, circulators, transmission lines or striplines, waveguides, and high frequency active devices such as transistors and diodes. More complex components, such as quadrature hybrids, mixers, filters, and attenuators, are built using these standard components. This chapter deals with the standard components and their models in high frequencies.

## 15.2.2 Multisim’s RF Components

The RF Design module contains over 100 parts and models specifically built for accuracy at higher frequencies. This ability to handle higher frequencies helps overcome a typical problem with SPICE models, which tend to perform poorly at such frequencies.

These parts are accessed by clicking the **RF** button in the **Component** toolbar.

There are several component Families in the RF parts group, including: RF capacitors, RF inductors, RF NPN BJTs, RF PNP BJTs, RF MOSFETs, RF tunnel diodes and RF striplines/waveguides.

Families containing components with wide commercial availability (for example, RF\_BJT\_NPN) have a large number of components within them. Families containing components that are not readily available “off-the-shelf” (e.g. RF inductors) contain only a few components. The latter were modeled using Multisim’s RF Model Makers, explained in “15.3 RF Instruments” on page 15-9. RF Model Makers are also used to customise your own parts, as explained in “15.5 RF Model Makers” on page 15-31.

## 15.2.3 Theoretical Explanation of the RF Models

This section explains some of the scientific theory behind the operation of RF components and why they must be modeled differently at higher frequencies. You do not need to understand this information to use the RF components in Multisim, but it may be of interest to you.

### 15.2.3.1 Striplines/Microstrips/Waveguides

Wires are used to connect two internal nodes on a circuit and show no difference in phase and magnitude between two connecting nodes. Wires, however, behave differently at RF frequencies depending on their length and diameter. One effect at RF frequencies is called the “skin effect”, explained below.

A conductor, at low frequencies, utilizes its entire cross-sectional area as a transport medium for charge carriers. As the frequency is increased, an increased magnetic field at the center of the conductor presents an impedance to the charge carriers, thus decreasing the current density at the center of the conductor and increasing it around its perimeter. This effect is called the “skin effect”, and occurs in all conductors, including resistor leads, capacitor leads, and inductor leads. As the frequency increases, this effect is more pronounced.

A simple wire connecting two nodes in high frequencies behaves as a transmission line. The following figure shows the equivalent circuit of a transmission line. There are four components. The capacitor is the result of an actual capacitance existing between the center of the conductor and the ground. Between these two plates is the dielectric, which is not perfect. This leakage is modeled using conductance  $G$  and is given per unit length of line. Also, due to the resistance of the conductor itself, we have a series resistance  $R$ . Its value depends on the resistivity of the material used, the length, the cross-section of the conductor, and the skin effects.

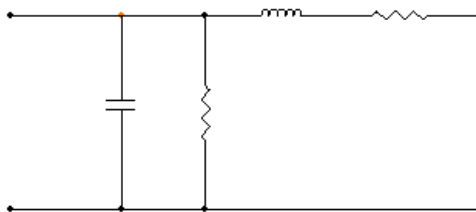

Every transmission line has a resistance, called its “characteristic impedance”. Most microwave systems have a characteristic impedance of 50 Ohms. This value is a compromise between maximum power handling capability and minimum attenuation. At 50 Ohms, there is a reasonably low attenuation, and adequate power handling capability.

If the outer diameter of the conductor of a coaxial line is shown by “D”, and the inner diameter is shown by “d”, and  $\epsilon$  is the dielectric constant of the cable, the characteristic impedance is calculated by the following formula:

$$Z_0 = \frac{138}{\sqrt{\epsilon}} \log_{10} \left( \frac{D}{d} \right)$$

The components C and L in the figure above are calculated as follows:

$$C = \frac{7.354\epsilon}{\log_{10}(D/d)} \quad ((\text{PF})/(\text{ft}))$$

$$L = 0 - 1404 \log_{10} (D/d) \quad ((\mu\text{H})/(\text{ft}))$$

A stripline is a useful form of a transmission line. The stripline consists of a conducting strip lying between, and parallel to, two wide conducting planes. The region between the strip and the planes is filled with a uniform dielectric.

Microstrips are easy to fabricate using photolithographic processes. At the same time that a transistor is placed on top of the board, for example, a microstrip can also be placed. Microstrip is, therefore, easily integrated with other passive and active devices. A conductor of width W is printed on a thin, grounded dielectric substrate of thickness “d” and relative permittivity “ $\mu_r$ ”.

A waveguide is a structure, or part of a structure, that causes a wave to propagate in a chosen direction.

If the waveguide boundaries change direction, the wave is constrained to follow. Waveguides come in a variety of types: simple parallel plate structure, cylindrical structures with conducting boundaries, rectangular waveguides, and circular waveguides. A transmission line or a stripline is a special case of waveguide.



### 15.2.3.2 RF Resistors

Resistors find many applications as terminators or attenuators. The equivalent circuit of a resistor at radio frequency is shown in the following figure. The inductor is calculated using the physical geometry of the resistor.

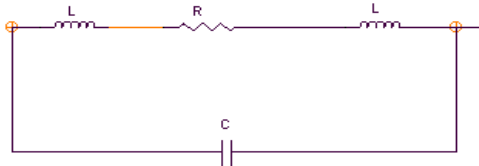

$$L = 0.002 l \left[ 2.3 \log \left( \frac{4l}{d} - 0.75 \right) \right] (\mu\text{H})$$

$l$  = length of wire in cm

$d$  = diameter in cm

### 15.2.3.3 RF Capacitors

Capacitors are used for interstage coupling, for bypassing, in resonant circuits, and in filters. RF capacitors must be chosen carefully to ensure the best performance for specific applications. RF capacitors consist of two metal plates separated by a dielectric. The capacitance of an *ideal* capacitor has a direct relationship with the area ( $A$ ), and is inversely proportional to the thickness of the dielectric ( $d$ ). Its relationship is expressed in the following formula, where  $\epsilon$  is the dielectric constant of the dielectric material.

$$C = (d\epsilon) \frac{A}{d}$$

The actual capacitor shows imperfection. One type of capacitor is modeled as shown in the following figure.

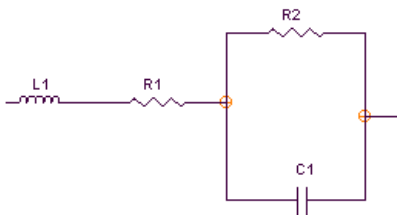

In order to find the numerical values of the ideal elements in the model above, we need to consider a number of factors.

Let  $\phi$  represent the phase of current compared to the voltage. This phase is ideally 90, but is smaller for real components. The power factor (PF) is defined as  $\cos(\phi)$ . This factor is a function of temperature, frequency, and the dielectric material. The power factor is usually used to describe the capacitor in low frequencies.

This factor in higher frequencies is sometimes referred to as the dissipation factor. This factor describes how much power is dissipated, lost, or transformed to heat energy in RF frequencies. Another factor that defines the quality of the capacitor is closely related to power factor and is called Q. This factor is the reciprocal of dissipation factor. The larger the Q, the better the capacitor.

No dielectric material is perfect. Therefore, there is always leakage current between two plates. This behavior is best described by  $R_p$  which is usually around 100,000 MOhm. The series resistor is the AC resistance of the capacitor in high frequencies, and is obtained using  $\cos(\phi)/C\omega * 1e6$ . Here,  $\omega = 2\pi f$ .

There is a frequency point above which the capacitor starts to behave like an inductor.

### 15.2.3.4 RF Inductors

Inductors are extensively used in resonant circuits, filters, and matching networks. The following figure shows a typical inductor modeled for RF frequencies. An inductor is a wire wound or coiled. Each two windings are at close proximity, which creates a distributed capacitor,  $C_d$ . The inductor would behave like a capacitor at high frequencies. There is always a series resistance which prevents the coil from resonating. The ratio of an inductor's reactance to its series resistance is often used as a measure of the quality of the inductor. The larger the ratio, the better the inductor is.

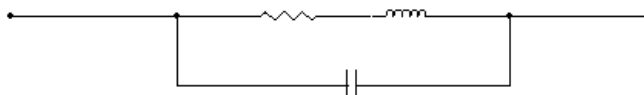

### 15.2.3.5 Active Devices

In low frequencies, active devices are modeled using a number of ideal components such as resistors and capacitors. In high frequencies, each of these ideal components should be replaced by its equivalent, as discussed earlier. For example, a resistor should be replaced by a resistor in series with an inductor. Some simplifications would reduce redundant components.

Two inductors in series, for example, can be replaced by one inductor. A typical equivalent circuit of an RF transistor is shown in the following figures.

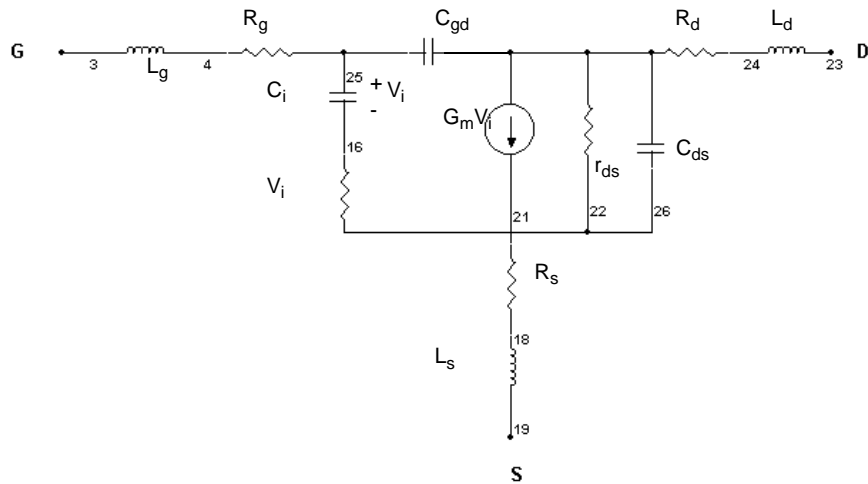
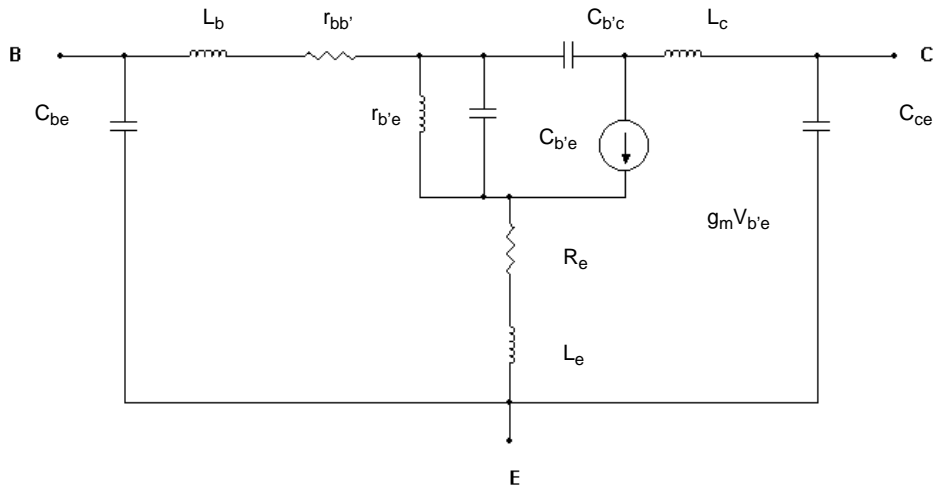

The cutoff frequency  $f_c$  can be derived from the equivalent circuit and is inversely proportional to the transit time  $\tau_c$ :

$$f_c = \frac{g_m}{2\pi C_i} = \frac{1}{2\pi \tau_c} = \frac{v_s}{2\pi L_g}$$

where  $L_g$  is the effective length of the gate, and  $v_s$  is the saturation velocity that electrons travel.

Active components included in Multisim are RF\_BJT\_NPN, RF\_BJT\_PNP, RF\_MOS\_3TDN, and tunnel diode.

## 15.3 RF Instruments



Multisim's RF Design module provides two key instruments for successful RF circuit design and analysis: the Spectrum Analyzer and the Network Analyzer.

### 15.3.1 Spectrum Analyzer

#### 15.3.1.1 About the Spectrum Analyzer

The spectrum analyzer is used to measure amplitude versus frequency. This instrument is capable of measuring a signal's power and frequency components, and helps determine the existence of harmonics in the signal.

One area that has an interest in spectrum measurement is communications. For example, cellular radio systems must be checked for harmonics of the carrier signal that might interfere with other RF systems. Other interesting applications of spectrum analysis are distortions of the message modulated onto a carrier.

The spectrum analyzer displays its measurements in the frequency domain rather than the time domain. Usually the reference frame in signal analysis is time. In that case, an oscilloscope is used to show the instantaneous value as a function of time. Sometimes a sine waveform is expected but the signal, rather than being a pure sinusoidal, has a harmonic on it. As a result, it is not possible to measure the waveform's level. If the same signal were displayed on a spectrum analyzer, its amplitude would be displayed, but so would its frequency components, that is, its fundamental frequency and any harmonics it may contain.

Time domain measurements such as rise and fall times, pulse width, repetition rates, delays, etc., cannot be easily obtained in frequency domain measurements. Therefore, both techniques are important.

#### 15.3.1.2 Using Multisim's Spectrum Analyzer

The spectrum analyzer in Multisim does not generate the noise one normally expects in a real spectrum analyzer. In reality, the noise generated by the spectrum analyzer itself (due to the random electron motion through the various circuit elements of an analyzer) is amplified by the various gain stages in the analyzer, and ultimately appears on the CRT as a noise signal

below which measurement cannot be made. With Multisim's spectrum analyzer, no additional noise is introduced by the instrument itself.

A number of parameters characterize a spectrum analyzer:

- frequency range in which the instrument operates
- frequency spans
- reference level
- measurement range.

These are all represented on the Multisim spectrum analyzer, and must be set manually.

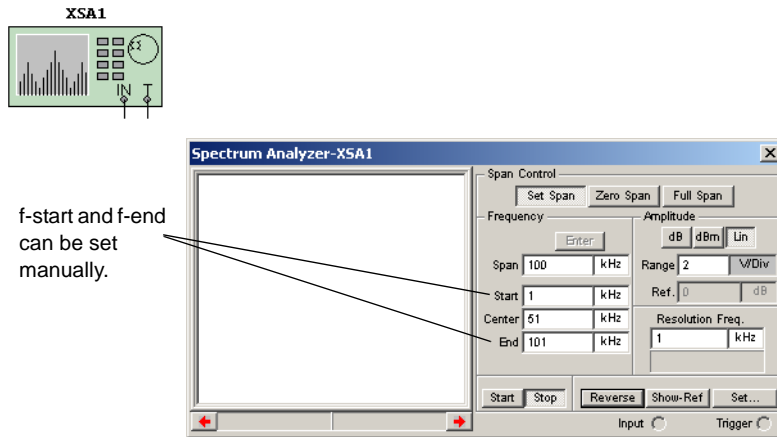

### 15.3.1.3 Frequency Range

Frequency range is the range of frequencies over which the spectrum analyzer will analyze signals. There are two frequencies that you manually set: f-start (minimum value 1kHz) is entered in the **Start** field and f-end (maximum value of 4 GHz) is entered in the **End** field. Zero frequency is not allowed for any of the frequency settings.

### 15.3.1.4 Frequency Spans

This parameter indicates the following frequency range to be displayed:

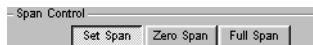

- If **Full Span** is selected, the entire instrument range, which is 1kHz to 4GHz, is displayed.
- If **Zero Span** is selected, a single frequency defined by the **Center** field is displayed.
- If **Set span** is selected, the frequency span is determined using either span control or frequency control, as explained in “15.3.1.5 Frequency Analysis” on page 15-11.

### 15.3.1.5 Frequency Analysis

There are two methods to select the frequency range:

- span control
- frequency control.

#### Span Control

This technique sets the span and the center frequencies, i.e., f-span and f-center.

- To set the span and the center frequencies, click **Enter** (in the **Frequency** area of the instrument's display) to automatically calculate the values of f-start and f-end using the following expressions:

$$f\text{-start} = (f\text{-center} - f\text{-span} / 2)$$

$$f\text{-end} = (f\text{-center} + f\text{-span}/2)$$

#### Frequency Control

You can define the starting and ending frequencies manually. In order to do this, you need to enter the numerical values of frequencies in the **Frequency** area of the dialog box. Their values should be non-zero values. When **Enter** is clicked, the center frequency (f-center) and the range of frequency displayed on the spectrum analyzer (f-span) are calculated automatically. The relationship among these parameters is expressed as follows:

$$f\text{-center} = (f\text{-start} + f\text{-end})/2$$

$$f\text{-span} = (f\text{-end} - f\text{-start})$$

Frequency	
Enter	
Span	100 KHz
Start	1 KHz
Center	51 KHz
End	101 KHz

These two techniques are interrelated, that is, it is not possible to set all four parameters independently. Both techniques are useful. For example, if you want to see frequency components around one specific frequency such as 100 MHz +/- 100 kHz, then the frequency control technique is easier to apply. The center frequency, in this example, is 100 MHz, and the span is  $2 \times (100 \text{ kHz}) = 200 \text{ kHz}$ .

### 15.3.1.6 Amplitude Range



You can set the amplitude range of the signal visible on the screen by choosing one of the following three options:

- **dB** - This option stands for  $20 \cdot \log_{10}(V)$ , where  $\log_{10}$  is the logarithm in base 10, and  $V$  is the amplitude of the signal. When this option is used, the signal is displayed by “dB per division”, shown in the right-hand side of the spectrum analyzer. The dB reading is of interest when measuring the power of the signal.
- **dBm** - This option stands for  $10 \cdot \log_{10}(V/0.775)$ . Zero dBm is the power dissipated in a 600 Ohm resistor when the voltage across it is 0.775 V. This power is equal to 1 mW. If the level of a signal is +10 dBm, it means that its power is 10 mW. When this option is used, the signal power is displayed based on the reference of 0 dBm. For applications in which the terminating resistor is 600 Ohm, such as in telephone lines, it is more convenient to read dBm as it is directly proportional to the power dissipation. However, in dB, you need to include the value of the resistor to find the dissipated power in the resistor. In dBm, the value of the resistor has been accounted for already.
- **Lin** - This option selects a linear display of the signal. To change the maximum amplitude displayed on the screen, enter a voltage value in the **Range** field.

### 15.3.1.7 Reference Level

The reference level is used to set the range of the input signal that can be displayed on the screen.

The axes of the spectrum analyzer are not marked by units and values. You can read the frequency and the amplitude of each point displayed on the screen by using the cursor. You can also right-click on the cursor to display a pop-up menu that lets you move the cursor to a precise point on the graph. When the cursor is moved and placed on the point of interest, the frequency and the amplitude in V, dB, or dBm are displayed below the graph.

You can observe more than one frequency and evaluate the results for the entire frequency range shown. You may want to know when the amplitude (in dB or dBm) of some components is above a certain limit in dB or dBm. For example, assume you are interested in the (-3dB) amplitude. By locating (-3dB) points you can estimate the bandwidth of the amplifier. By clicking **Show-Ref**, you can set the reference level to (-3dB) and, using the cursor at the same time, you can find the lower edge and upper edge of the pass band.

You can also find out whether the amplitude of the signal is less than a certain value for a certain band of frequency. To do this, observe signals on the spectrum analyzer, and use the

reference button. The maximum reference value in dB is set to (+30 dB). **Show-Ref** is available only if either **dB** or **dBm** are activated.

### 15.3.1.8 Frequency Resolution

The frequency resolution is initially set to a minimum value of  $\Delta f = f_{\text{end}}/1024$ . However, you can change it to a greater value and observe the spectrum. You need to select the frequency resolution so that the frequencies are integer multiples of frequency resolutions.

**Note** For an accurate reading, the frequency components should not be below  $\Delta f$ .

### 15.3.1.9 Examples

#### Example 1

The following figure shows a mixer, which is often used in communications applications.

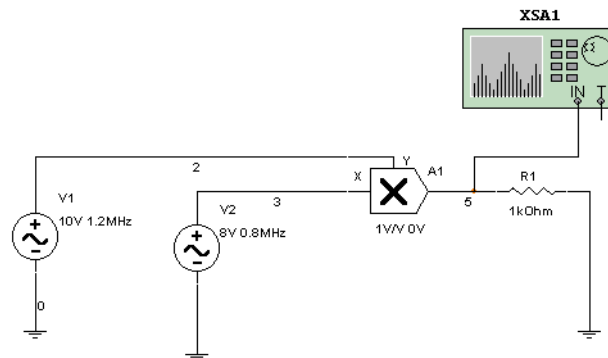

There are two input sinusoidal waveforms. Their frequencies are 0.8 MHz and 1.2 MHz. The amplitudes are set at 8 V and 10 V, respectively. Note that the amplitude is the peak value of the sinusoidal waveform—it is not the RMS value of the waveform. The mixer is set to multiply the signals with unity gain without introducing an offset in either of the input signals. You can expect to find two components at the output placed at  $(1.2 + 0.8) = 2$  MHz, and  $(1.2 - 0.8) = 0.4$  MHz.

- If you want to try this example for yourself, do the following:
1. Construct the network as shown above.
  2. Double-click on the multiplier and set the gains to 1 and the offsets to zero.
  3. Double-click on the spectrum analyzer and initialize it using one start and end frequency (example 3 in this chapter shows another way to initialize the spectrum analyzer).
    - Set **Span** to 3MHz and **Center** to 1.8 MHz.



- Click **Enter**. The frequency value of f-start is automatically set to  $(1.8 \text{ MHz} - 3/2 \text{ MHz}) = 300 \text{ kHz}$ . The frequency value of f-end is automatically set to  $(1.8 \text{ MHz} + 3/2 \text{ MHz}) = 3.3 \text{ MHz}$ .
  - Since the amplitude of the component is around  $(8 * 10) / 2 = 40 \text{ V}$ , set the amplitude range to  $100 \text{ V}$  in “LIN” mode.
4. Run the simulator.
  5. Double-click on the spectrum analyzer.
  6. Click **Start** and wait until the signal stabilizes

The spectrum analyzer starts performing the Fourier Transform of the input signal in time domain. However, since it begins with only a few samples, it does not provide accurate results initially. You must wait until the screen is refreshed a few times to obtain accurate readings of the frequency components and their magnitudes. At this time, the internal frequency resolution is equal to the user-defined frequency resolution. Both of these values are shown on the device. Using the cursor on the screen, you can read the amplitude and frequency of each component. In the example, the readings are the same as the calculated values, that is, two frequency components at  $2 \text{ MHz}$  and  $0.4 \text{ MHz}$ , with  $40 \text{ V}$  magnitude.

## Example 2

In order to run another example, you must stop the simulation running for the previous example. The second example has the same circuit structure, as shown below.

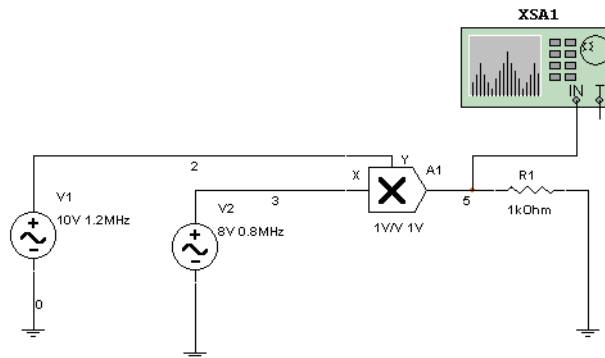

However, DC offsets ( $1 \text{ V}$ ) to the input and the output signals are introduced. Due to the offsets, you will have components at DC, as well as  $0.8 \text{ MHz}$  and  $1.2 \text{ MHz}$ . The spectrum analyzer shows the components and their amplitude on the screen if the same setting used in the previous example is also used here.

### Example 3

This example considers an active device that works in saturation. This structure is shown below:

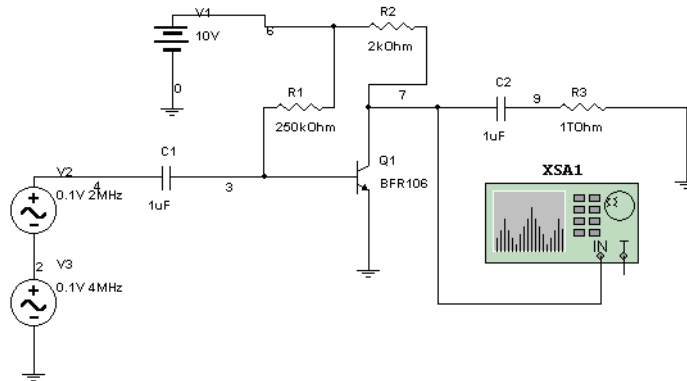

➤ To initialize the spectrum analyzer:

1. Double-click on the spectrum analyzer.
2. Set **Start** to 1 kHz and **End** to 11MHz.
3. Click **Enter**. The frequency value of f-span is  $(11 \text{ MHz} - 1 \text{ kHz}) = 10.999 \text{ kHz}$ . The frequency value of f-center is  $(11 \text{ MHz} + 1 \text{ kHz})/2 = 5.5005 \text{ MHz}$ .
4. Set the range to 2 dB/division, and set the reference to 4 dB to demonstrate the application of reference dB level.

The frequency values of f-start and f-end are set so that the frequency components of interest are captured and their magnitudes can be studied. Using the spectrum analyzer, you can verify that there are more than two frequency components present at the output node. There are three components above 4 dB—zero frequency, 2 MHz, and 4 MHz. Other frequency components are at higher frequencies and have dB level less than 4 dB.

## 15.3.2 Network Analyzer

### 15.3.2.1 About the Network Analyzer

The network analyzer is used to measure the scattering parameters (or S-parameters) of a circuit, commonly used to characterize a circuit intended to operate at higher frequencies. These S-parameters are used for a variety of purposes, including in Multisim RF analyses. The network analyzer also calculates H, Y, Z parameters.

## 15.3.2.2 Using the Network Analyzer

The circuit is idealized as a two-port network. To properly use the network analyzer, the circuit must be left open at its input and output ports. During simulation the network analyzer completes the circuit being analyzed by inserting its subcircuits. You must remove these subcircuits from the circuit before performing other analysis and simulation.

When you start simulation, the network analyzer automatically executes two AC analyses. The first AC analysis is applied at the input port to compute the forward parameters  $S_{11}$  and  $S_{21}$ . The second analysis is applied at the output port to compute the reverse parameters  $S_{22}$  and  $S_{12}$ . After the S-parameters are determined, you can use the network analyzer to view the data in many ways and perform further analyses based on the data.

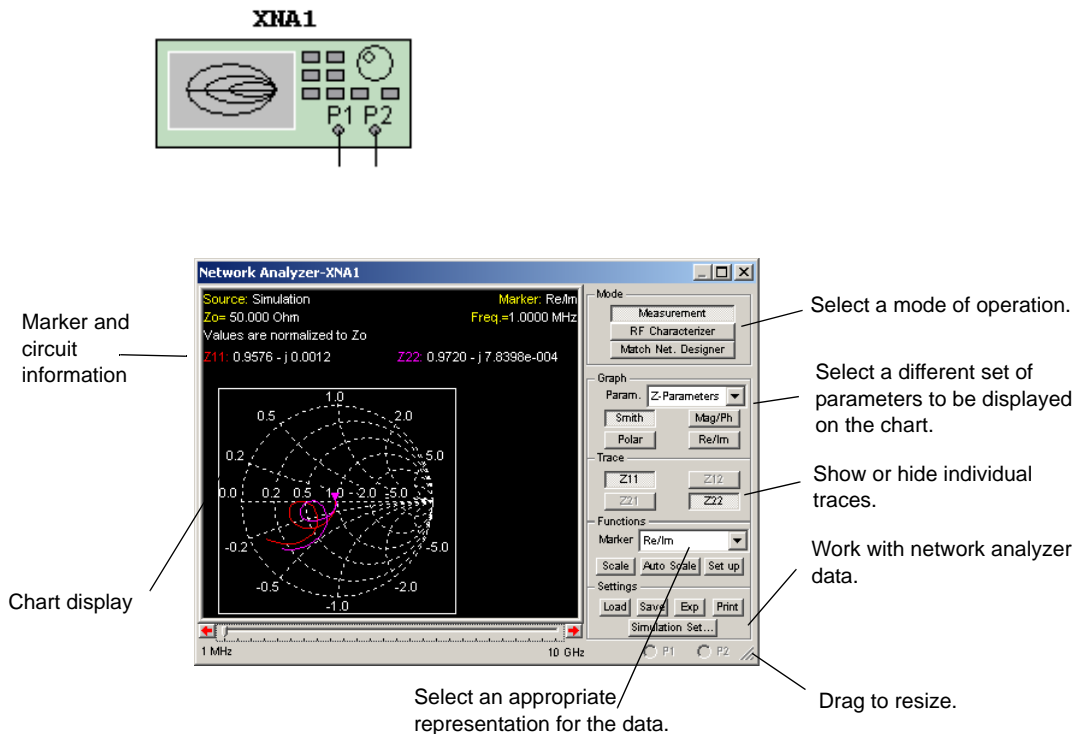

The display of the network analyzer is divided into two regions:

- The left region contains a chart display area and a text display area that shows marker and circuit information.
- The right region contains the controls for the network analyzer.

### 15.3.2.3 Marker Controls

Select from the **Marker** drop-down list how you want data represented:

- Real/Imaginary (**Re/Im**)
- Magnitude/Phase (**Mag/Ph(Deg)**)
- dB (Magnitude)/Phase (**dB Mag/Ph (Deg)**).

Use the left and right arrows below the graph to step through each data point acquired for the circuit. Initially, the frequency points are selected in decade. The default frequency sweep range is between 1 MHz and 10 GHz. You can also use the PAGE UP and PAGE DOWN keyboard keys to navigate the data set.

### 15.3.2.4 Trace Controls

Use the **Trace** buttons to show and hide each individual trace on the chart. When the network analyzer is opened, S11 and S22 are shown in the trace area. The trace buttons change depending on what parameter or analysis is being looked at. The possible sets in “Measurement” mode are {S11, S12, S21, S22}, {Z11, Z12, Z21, Z22}, {H11, H12, H21, H22}, {Y11, Y12, Y21, Y22}, {K,  $|\Delta|$ }. The possible sets in “RF Characterizer” mode are {P.G., T.P.G., A.P.G.}, {V.G.}, and {Zin, Zout}. For more about these modes, see “15.3.2.7 Mode Controls” on page 15-18.

### 15.3.2.5 Format Controls

#### Parameter Options

Select the set of parameters to be displayed on the chart. The parameters available depend on the network analyzer’s mode. In “Measurement” mode, you can choose from S-, Y-, H-, Z-parameters, and stability factors K and  $|\Delta|$ . In “RF Characterizer” mode, select from Power gains, Voltage gains, and Impedance.

#### Format Buttons

Use these buttons to display data using different chart formats. The formats available depend on the selected parameter group.

Use the **Scale** button to change the scaling of the current chart. Only Polar plot, Real/Imaginary plot and Magnitude/Phase plot can be changed.

Use the **Auto Scale** button to automatically scale the data so that it can be displayed within the current chart.

Use the **Setup** button to change the various display properties of the network analyzer.

### 15.3.2.6 Data Controls

Use the **Save** button to save the current S-parameter data set to file.

Use the **Load** button to load a previously saved S-parameter data set into the network analyzer. Once the data is loaded, you can use all the functions provided by the network analyzer to view and analyze the data. The saved S-parameter file has the file extension `.sp`.

Use the **Exp** button to export the data set of the selected parameter group to a text file. For example, if the selected parameter group is Z-parameters displayed in magnitude/phase chart format, Z-parameters will be exported, and their values will be in magnitude/phase format.

Use the **Print** button to print the selected chart.

### 15.3.2.7 Mode Controls

From the **Mode** box, click the button for the desired network analyzer mode:

- **Measurement**—provides the parameters in different formats
- **RF Characterizer**—provides the power gains, voltage gains, and impedances seen from input and output ports
- **Match Net. Designer**— opens a new dialog box, explained in “15.4.2 Matching Network Analysis” on page 15-20.

Use the first of the above choices to use the Network analyzer to perform measurement (its normal application). Use the second and third options to access the two RF analyses explained in “15.4 RF Analyses” on page 15-18.

Use the **Simulation Set** button to enter the measurement settings for computing the circuit’s S-parameters.

## 15.4 RF Analyses

### 15.4.1 RF Characterizer Analysis



Multisim’s RF characterizer analysis tool helps designers study RF circuits in terms of their power gains, voltage gain, and input/output impedances. A typical application is an RF amplifier. The source signal at the input of an amplifier is usually provided by a receiver and its power is relatively small. The RF designer often intends to magnify the input signal and provide an output signal in terms of both voltage and current: i.e., the output power delivered to the load is considerably higher than that of the input signal. That is why the power transferability of the designed circuit is of interest. The power gains in Multisim are

calculated by assuming that source and load impedances are 50 Ohm. You can change these values by clicking the **RF Param. Set** button to specify that the RF simulator assumes

$$Zl = Zo \text{ and } Zs = Zo \text{ or } \Gamma_s = \Gamma_l = 0.$$

Another aspect of a circuit is the input and output impedances of the amplifier. An RF amplifier usually has more than one stage of amplification. Each stage of the amplifier is loaded by the input port of the next stage.

The loading effect is best understood by studying the input/output impedances. Most engineers would like to design an amplifier which has maximum input impedance in low RF frequencies, to reduce its loading effect on the previous stage. On the other hand, the smaller the output impedance is, the better the output signal would be delivered. In higher RF frequencies, it is desirable to have an output impedance matching that of the load to minimize the reflection of signals. The Multisim RF characterizer analysis toolbox helps designers to study these impedances and choose the most appropriate frequency of operation.

- To use the simulator in order to read the desired variable:
  1. Connect the network analyzer to the amplifier.
  2. Run the simulator. Ignore the DC warnings and wait until the AC analyses are complete.
  3. Double-click on the network analyzer.
  4. Click on **RF Characterizer** in the **Mode** box.
  5. Under the **Trace** options, set the desired variable, from among **PG**, **APG.**, and **TPG**. While the curves are plotted versus frequency, the numerical values are displayed at the top of curves for each frequency point.
  6. From the **Parameter** drop-down list, select “Gains”. Here, the voltage gain (VG>) is plotted versus frequency and its value is given at the top of the curve.

**Note** Use **Auto Scale** each time you change the parameters to get a better reading.

  7. In the **Parameter** drop-down list, select **Impedance**. The input/output impedances are provided in the form of a curve as well as printed out at the top of the curves.
  8. Use the frequency scroll bar at the bottom of the curves to select the desired frequency for a specific variable.

## Power Gains

The Multisim RF Simulator calculates the General Power Gain (PG), Available Power Gain (APG) and Transducer Power Gain (TPG) for  $Zo = 50\text{Ohm}$  at a given frequency. The dBMag is derived as  $10\log_{10} |PG|$ .

PG is defined as the ratio of the power delivered to the load and the average power delivered to the network from the input, and is given as  $PG = |S21|^2 / (1 - |S11|^2)$ .

The Transducer Power Gain, TPG is the ratio of the power delivered to the load to the power available from the source. For  $G_s = G_L = 0$ ,  $TPG = |S21|^2$ .

The Available Power Gain, APG is the ratio of the power available from the output port of the network to the power available from the source and it is expressed as

$$APG = |S_{21}|^2 / (1 - |S_{22}|^2)$$

### Voltage Gain

Voltage Gain, VG, is obtained for  $\Gamma_s = \Gamma_1 = 0$  and is expressed as  $VG = S_{21}/(1 + S_{11})$ .

Voltage Gain expressed in dBMag is calculated as  $20 \log_{10} |VG|$ .

If you observe the time domain signals of the input and output while the transistors are operating in the linear region, you find that the amplitude of the output voltage signal (when 50 Ohm load and source impedances are used) to the amplitude of the input voltage signal is the same as VG given by Multisim. Note, however, that VG is calculated using S-parameters.

### Input/Output Impedances

These values are calculated assuming  $\Gamma_s = \Gamma_1 = 0$ . For this condition, we have:

$$Z_{in} = (1 + \Gamma_{in}) / (1 - \Gamma_{in}) \quad \text{where } \Gamma_{in} = S_{11} \quad \text{and}$$

$$Z_{out} = (1 + \Gamma_{out}) / (1 - \Gamma_{out}) \quad \text{where } \Gamma_{out} = S_{22}.$$

One must note that these values are normalized. The simulator prints denormalized values of  $Z_{in}$  and  $Z_{out}$ .

## 15.4.2 Matching Network Analysis



While designing RF amplifiers using Multisim, RF engineers need to analyze and, if necessary, modify circuit behavior. The Matching Network Analysis provides three options for analyzing circuit behavior:

- Stability circles
- Unilateral gain circles
- Impedance matching.

These options are described in detail in this section. Depending on the application, one or more of the options is used. For example, to design oscillators only stability circles are used. On the other hand, to match an unconditionally stable circuit, the simulator first analyzes the stability properties of the circuit then uses automatic impedance matching.

The three options are accessed from the **Match Net. Designer** dialog box.

**Note** Before opening the **Match Net. Designer** dialog box, you must activate the circuit by clicking the **Run/Stop Simulation** button and stop the simulation by clicking the button again.

- To open the **Match Net. Designer** dialog box:
  1. Double-click the **Network Analyzer** on the circuit window.
  2. Click the **Match Net. Designer** button. The **Match Net. Designer** dialog box appears:

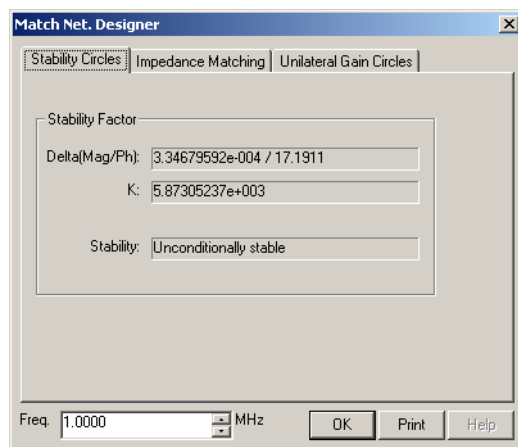

## Stability Circles

Stability circles are used to analyze the stability of a circuit at different frequency points.

In an ideal design, when an input signal is delivered to the input port of a two-port network, the entire source signal is delivered without any loss. In practice, however, part of the input signal bounces back to the source. Then, when the amplified signal is delivered to the load impedance, part of this signal bounces back to the output port of the amplifier. The amplifier, if it is not unilateral, transfers the reflected wave back to the source impedance. A circuit is considered unstable if the signal reflected is equal to the signal delivered in either the input or the output port.

An RF engineer aims to minimize this “bounce” effect and deliver maximum signal to the load. The stability circles in the network analyzer help achieve this goal.

- To perform the analysis:
  1. Connect the biased amplifier to the network analyzer using two series capacitors (usually 100 F). The values of these capacitors are selected to minimize the numerical errors. In practice, however, two capacitors must be used to isolate the amplifier from the pre- and post-stage amplifiers in DC mode. Note that the impedance of these capacitors should not contribute to the attenuation of the input or output signal. The impedance of a capacitor is frequency dependant and is calculated using  $X_c = 1/(j\omega C)$  where “ $\omega$ ” is  $(2\pi \cdot f)$ .
  2. To activate the network analyzer, click **Run/stop simulation**. Wait until the AC-analyses are complete. Ignore the warning for DC-analysis.



3. Double-click on the Network Analyzer icon on the circuit window.
4. Click the **Match Net. Designer** button.
5. From the **Match Net. Designer** dialog box, click the Stability Circles tab.
6. Set the desired operating frequency in the **Freq.** field in the lower left corner of the dialog box, and click **OK**.

The result is a Smith Chart showing an input stability circle and an output stability circle. A stability circle represents the boundary between the values of source or load impedance that cause instability and those that do not. The perimeter of the circle thus represents the locus of points which forces  $K=1$ . Note that either the inside or the outside of the circle may represent an unstable region. Unstable regions are hashed on the Smith Chart.

There are three possible scenarios on the Smith Chart, as described below:

- **None of the Smith Chart is hashed** In this case the circuit is said to be “unconditionally stable”, meaning that any area of the Smith Chart represents a valid passive source or load impedance. The designer can, then, select the input or output impedances using other criteria (such as gain or noise criteria).
- **Parts of the Smith Chart are hashed** In this case the circuit is “potentially unstable”, meaning it is possible to select passive input or output impedance and still maintain the stability of the circuit. An input impedance should fall outside the hashed area of the input stability circle to achieve stability at the input port, while an output impedance should be selected outside the output stability circle to achieve stability at the output port.
- **The entire Smith Chart is hashed** In this case, the circuit is unstable regardless of input or output impedances. The designer has a number of options to achieve stability, including changing the frequency of operation, changing the DC biasing of the transistor, changing the transistor itself, or changing the entire structure of the amplifier.

In addition to stability circles, there are two numerical values printed on the “Match Net. Designer” dialog box. They are  $\Delta$  and “K”. The design is unconditionally stable if  $(|\Delta| < 1)$  and  $K > 1$ . For  $K < 1$ , for example, the circuit is potentially unstable, and will most likely oscillate with certain combinations of source or load impedance.

## Unilateral Gain Circles

This option is used to analyze the unilateral property of a circuit. A transistor is said to be unilateral when there is no “bounce” effect, meaning the signal reflected from the output port to the input port is zero. This occurs if the reverse transmission coefficient,  $S_{12}$  or the reverse transducer power gain,  $|S_{12}|^2$  is equal to 0. This means that the input section of the amplifier is completely isolated from the output section. (Note that passive networks are usually not unilateral.)

The unilateral property of a network is determined by calculating the “Unilateral Figure of Merit” (U). If necessary, the frequency can be adjusted to improve the unilateral property.

- To calculate the “Unilateral Figure of Merit”:
  1. From the **Match Net. Designer** dialog box click the Unilateral Gain Circles tab.
  2. Read the value of “U” or the “Unilateral Figure of Merit”.
  3. Calculate the upper and lower limits of the following inequality using “U”.
 
$$1/(1 + U)^2 < G_T/G_{TU} < 1/(1-U)^2$$
 where, **G<sub>T</sub>** – **transducer power gain**, is defined as the ratio of the output power delivered to a load by a source and the maximum power available from the source, and **G<sub>TU</sub>** represents the transducer power gain assuming unilateral property (S<sub>12</sub>=0) for the network. You need not calculate G<sub>T</sub> or G<sub>TU</sub> since only the limits are of interest here. If the limits are close to one, or “U” is close to zero, the effect of S<sub>12</sub> is small enough to assume unilateral property for the amplifier. If it is not, go to the next step.
  4. Change the frequency so that the minimum “U” is read. This frequency suggests an operating point for the amplifier where the unilateral property is best met.

**Note** The operating frequency to achieve the best unilateral property for the amplifier does not necessarily coincide with the maximum gain for the circuit. The unilateral gain circles are developed to identify the best load and source impedances to minimize the error due to unilateral assumption and maintain a satisfactory level of gain. The gain circles are also used for a trade off between the gain and the bandwidth.

### Wide Band Amplifier

- To design a wide band amplifier, first find the maximum gain delivered by the circuit:
  1. Double-click the network analyzer icon on the circuit window.
  2. Click on the **RF characterizer** button.
  3. Read the value of TPG (transducer power gain or **G<sub>T</sub>**). This value is printed in dB.
  4. Click on the **Match Net. Designer** button.
  5. From the **Match Net. Designer** dialog box, click the Unilateral Gain Circles tab.
  6. Change the value of G<sub>s</sub> and G<sub>l</sub> manually and individually until the circles become a dot on the Smith Chart.
  7. Calculate the maximum transferable power.
 
$$G_{max} = G_s \text{ (dB)} + \text{TPG (dB)} + G_l \text{ (dB)}$$

The maximum gain is achieved only for a narrow band. Since the slightest change in the circuit component would change its performance, the maximum gain is not achievable in reality. For a wider band of frequency, use a gain of less than the maximum.
- Knowing the level of gain you want to achieve, select input and output impedances:
  1. Select the desired gain (should be less than the maximum gain calculated above).

2. Choose  $G_s$  and  $G_l$  so that these three conditions are met:
  - $G_s + G_{TU} + G_l < G_{max}$
  - $G_s < G_{smax}$
  - $G_l < G_{lmax}$ .
3. Enter the selected values for  $G_s$  and  $G_l$  and observe the circles. Select points on the circles closest to the center of the Smith Chart. These points are shown on the Smith Chart and circles by two triangles. The circle for  $G_l = 0$  dB always passes through the center. Therefore, the best point of the  $G_l$  to produce  $G_l = 0$  dB.

Any point selected on the Smith Chart is a normalized point. These points provide the impedances for the input and output ports that you then design manually.

**Note** To ensure these points will not cause instability, we recommend you follow the instructions in “Stability Circles” on page 15-21. If the amplifier is “unconditionally stable”, it would be stable for any passive load or source network, so you need not check stability circles in this case.

## Impedance Matching

Occasionally, a design is considered “unconditionally stable”, meaning the amplifier does not oscillate in the presence of any passive load or source impedance. In this case, you can use the impedance matching option to automatically modify the structure of an RF amplifier to achieve maximum gain impedance.

To deliver maximum power, a circuit must match at both its input and output ports. In other words, there needs to be maximum matching between the output of the amplifier and the output impedance, and the input of the amplifier and the source impedance. There are eight possible structures for each port, although only a few of these provide complete matching.

- To use impedance matching to find a matching network:
1. Connect the network analyzer to your amplifier as described in “Stability Circles” on page 15-21. Do not forget the capacitors in order to prevent DC loading of the network analyzer.
  2. Run the simulation.
  3. Double-click the network analyzer icon.
  4. Click the **Match Net. Designer** button.
  5. On the **Match Net. Designer** dialog box, click the Impedance Matching tab.
  6. Change the frequency to the desired operating point.
  7. Enable the **Auto Match** checkbox.

The instrument provides the structure as well the numerical values of components. You can click on the left and right sides of the Impedance Matching dialog box and change the structure. However, only a few of the eight structures can provide matching.

## 15.4.3 Noise Figure Analysis



The noise figure, or NF, is used to specify exactly how noisy a device is. For a transistor, noise figure is simply a measure of how much noise the transistor adds to the signal during the amplification process.

In a circuit network, the noise figure is used as a “figure-of-merit” to compare the noise in a network with the noise in an ideal or noiseless network. It is a measure of the degradation in signal-to-noise ratio (SNR) between the input and output ports of a network.

When calculating the noise figure of a circuit design, *Noise Factor* (F) must also be determined. This is the numerical ratio of NF, where NF is expressed in dB. Thus,

$$NF = 10 \log_{10} F$$

And,

$$F = \frac{\text{Input SNR}}{\text{Output SNR}}$$

The noise figure for any device is provided in the part datasheet and is plotted similar to the graph below (for the 2N4957):

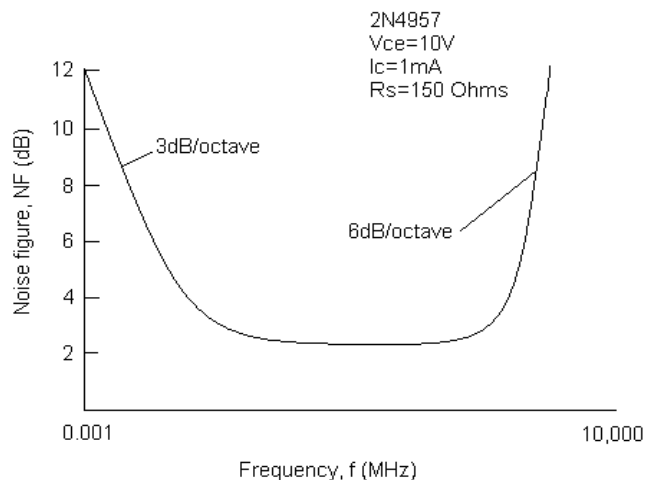

Another method of describing noise figure is using the following formula:

$$NF = 10 \log_{10} \frac{Si/Ni}{So/No}$$

$$= 10 \log_{10} NR$$

Where  $Si/Ni$  is the signal-to-noise power ratio at the device's input and  $So/No$  is the signal-to-noise power ratio at its output. The term  $(Si/Ni, So/No)$  is called the *noise ratio* (NR). If the device under consideration were ideal (injected no additional noise), then  $Si/Ni$  and  $So/No$  would be equal, the NR would equal 1, and  $NF = 10 \log_{10}(1) = 0$  dB. Of course, this result cannot be obtained in practice.

## Cascaded Networks

The following is an example of a cascade network.

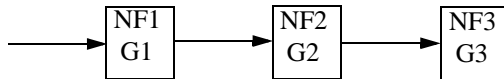

Often, it is necessary to calculate the noise figure of a group of amplifiers that are connected in cascade. This is easily done if the noise figure of each individual amplifier in the cascade configuration is known.

$$F_{\text{total}} = F1 + \frac{F2-1}{G1} + \frac{F3-1}{G1G2} + \frac{F4-1}{G1G2G3}$$

Where,

$F_n$  = the noise factor of each stage

$G_n$  = the numerical gain of each stage (not in dB)

Another look at the above equation will reveal a very interesting point. If the gain of the first stage is sufficiently high, the denominators of the second and succeeding terms will also be very large (since  $G1$  is multiplied with the denominator of every term). This will force all other terms to be very small values leaving only  $F1$  in the equation. Hence, the NF of the first stage will typically determine the NF of the cascade network.

## Noise Figure in SPICE Models

In order to understand how Noise Figure Analysis operates within Multisim, we must first understand how noise figure is introduced to a SPICE model.

Every part in a Multisim circuit design contains a SPICE model. This SPICE model describes how the part functions in simulation. There are two possible methods of constructing a model.

- Create a SPICE circuit that emulates the function of the desired part (eg: Opamp model in SPICE is constructed using several transistors, resistors, etc).

- Certain components are already defined in a SPICE engine (eg: Transistors). Models for these components are simply a list of parameter values (eg: Beta) that feed into a 'predefined' circuit already included in the SPICE engine.

For this Analysis, we will analyze option 2.

Below is a SPICE model for a typical transistor:

```
.MODEL BF517 NPN (IS=0.480F NF=1.008 BF=99.655 VAF=90.000
IKF=0.190
+ ISE=7.490F NE=1.762 NR=1.010 BR=38.400 VAR=7.000 IKR=93.200M
+ ISC=0.200F NC=1.042
+ RB=1.500 IRB=0.100M RBM=1.200
+ RE=0.500 RC=2.680
+ CJE=1.325P VJE=0.700 MJE=0.220 FC=0.890
+ CJC=1.050P VJC=0.610 MJC=0.240 XCJC=0.400
+ TF=56.940P TR=1.000N PTF=21.000
+ XTF=68.398 VTF=0.600 ITF=0.700
+ XTB=1.600 EG=1.110 XTI=3.000
+ KF=1.000F AF=1.000)
```

Although noise figure in a model is achieved using a combination of several model parameters, parameter NF is the most significant value (when simulating noise figure in a transistor model). When selecting a SPICE model to use for Noise Figure Analysis, you must insure that this parameter exists. If not, the part will operate without noise parameters and therefore will generate no noise.

For a description of all parameters available in the above SPICE model or in any other SPICE model, please refer to Berkeley SPICE manual available through the University of Berkeley.

### 15.4.3.1 Multisim Approach

Multisim calculates the noise figure using the equation:

$$F = \frac{N_o}{GN_s}$$

Where  $N_o$  is the output noise power (which includes the noise due to two-part network and the magnified input noise)  $N_s$  is the thermal noise of the source resistor (this resistor generates noise equal to the output noise of the previous stage), and  $G$  is the AC gain of the circuit (the

ratio of the output signal to the input signal of the two-part network). Note that the bandwidth of the signal has been considered in the source resistor.

Finally, Multisim prints the Noise Figure in dB, that is  $10 \log_{10}(F)$ .

### 15.4.3.2 Noise Figure Analysis Tabs

Just as for other Multisim analyses, you need to fill in the appropriate fields from the Analysis Parameters tab.

Analysis parameters are shown below:

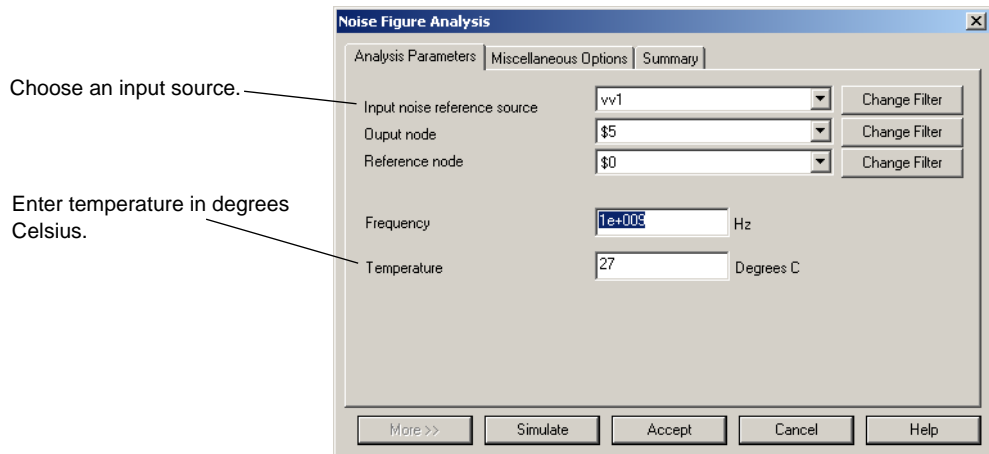

### Setting Noise Figure Analysis Parameters for Normal Use

For normal use, you only need to:

- select an input source from the **Input noise reference source** drop-down list
- select an output node from the **Output node** drop-down list
- select a reference node from the **Reference node** drop-down list
- enter a value in the **Frequency** field
- enter a value in the **Temperature** field. The default setting of 300.15 degrees Kelvin is equivalent to 27 degrees Celsius.

You can filter the variables displayed to include internal nodes (such as nodes inside a BJT model or inside a SPICE subcircuits), open pins, as well as output variables from any submodules contained in the circuit.

➤ To filter the variables displayed:

1. Click the **Change Filter** button. The **Filter Nodes** dialog box appears.

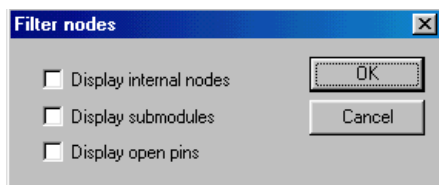

2. Enable one or more settings.

3. Click **OK**.

### 15.4.3.3 Sample Noise Figure Analysis

To illustrate how Noise Figure Analysis operates, we will use the following circuit:

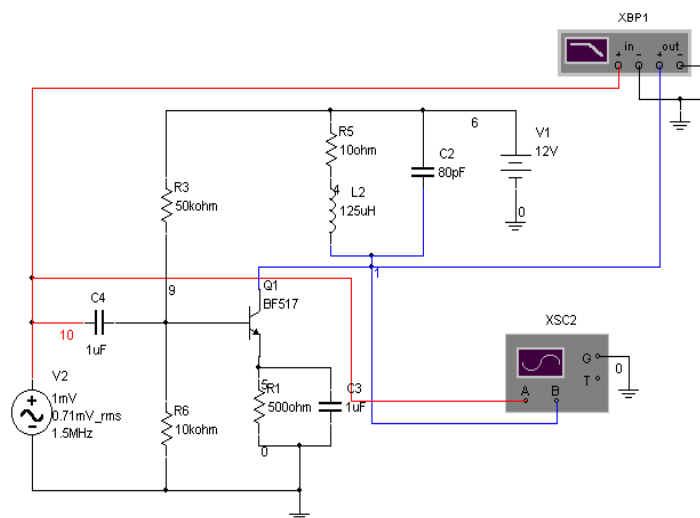



The circuit frequency response is shown below:

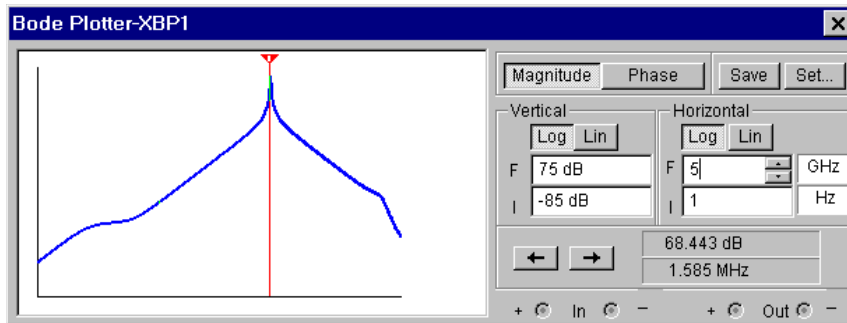

Notice that the maximum gain appears at approximately 1.5MHz.

- To set up Noise Figure Analysis using the circuit shown, follow the steps listed below.
  1. Select **Simulate/Analyses/Noise Figure Analysis**.
  2. Under the Analysis Parameters tab, set the following:
    - **Input noise reference source** to VV1 (which is the input AC Source).
    - **Output node** must be \$1.
    - **Reference node** will default to \$0
    - **Frequency** must be set to 1.5e+6 (1.5 MHz).
    - **Temperature** must be set to 27 degrees.
  3. Click **Simulate**. The following displays.

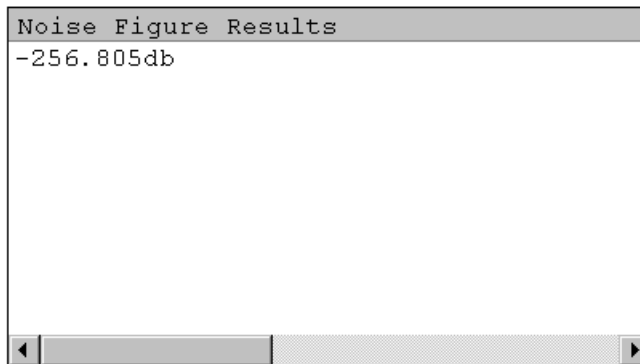

Therefore, the Noise Figure for the circuit is approximately -260 dB.

## 15.5 RF Model Makers



As with the other Multisim Model Makers, RF Model Makers automatically simulate models based on the input you provide. Whereas input for other model makers usually comes from data books, RF Model Makers can also receive other types of input, such as operating characteristics or physical dimensions, depending on the type of components you are modelling.

Multisim has RF Model Makers for the following types of components:

### 15.5.1 Waveguide

For Waveguide models, enter values in the two tabs shown below. Use the following diagram for assistance in identifying the values:

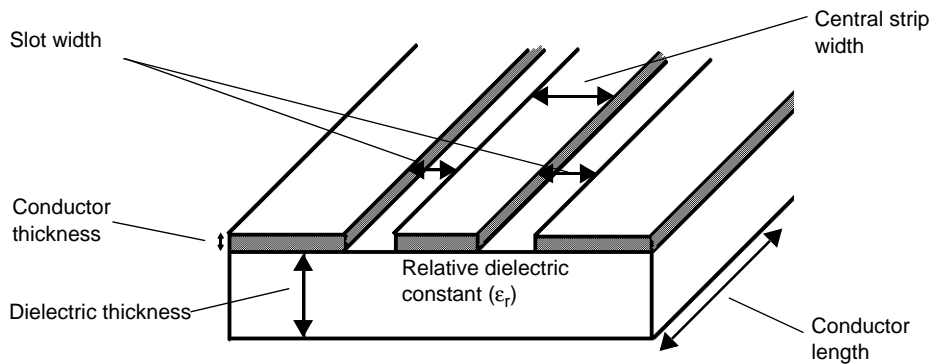

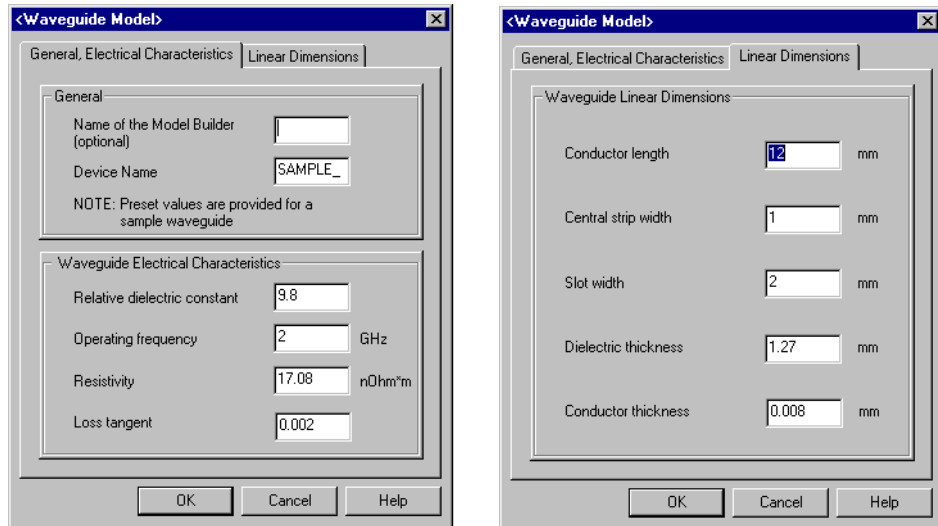

## 15.5.2 Microstrip Line

For the Generic Microstrip Line models, enter values in the two tabs shown below. Use the following diagram for assistance in identifying the values:

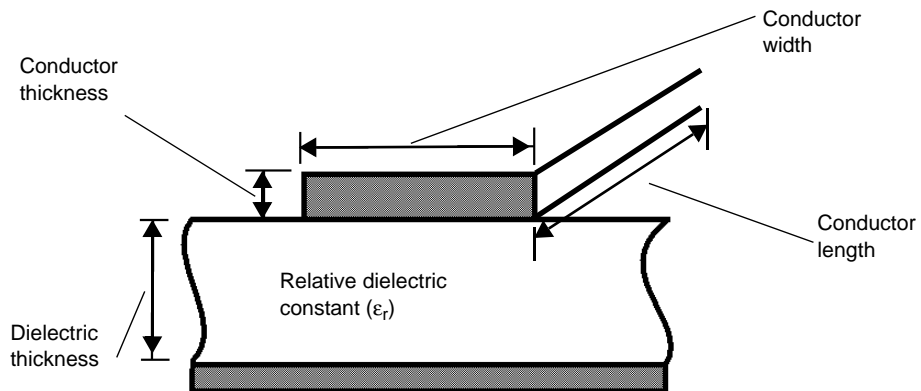

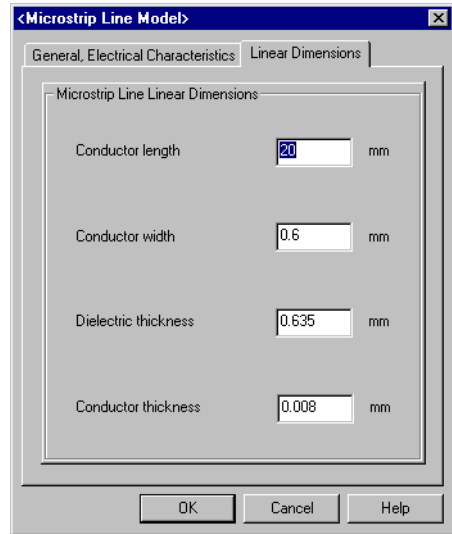
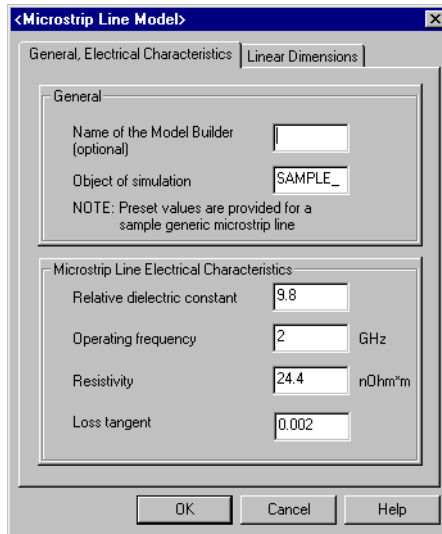

## 15.5.3 Open End Microstrip Line

For Open End Microstrip models, enter values on the following tabs:

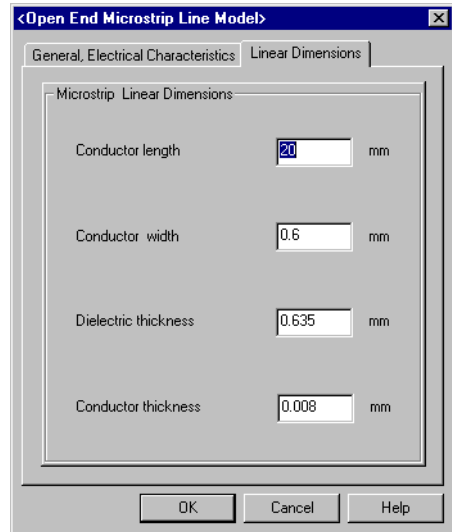
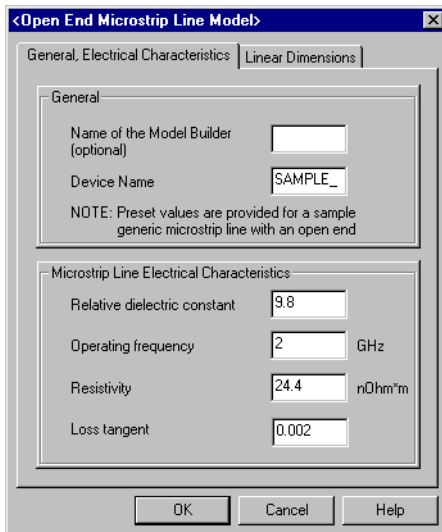

## 15.5.4 RF Spiral Inductor

For the RF Spiral Inductor models, enter values in the two tabs shown below. Use the following diagram for assistance in identifying the values:

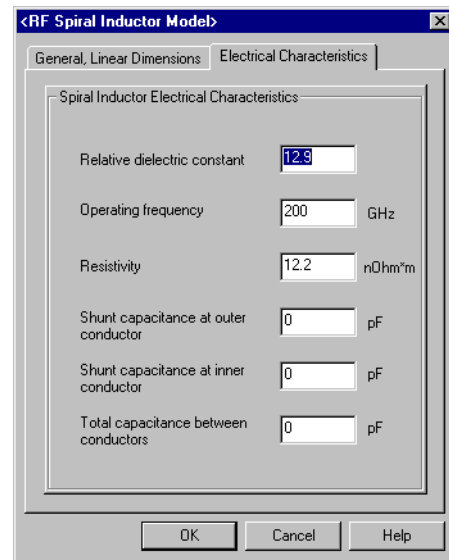
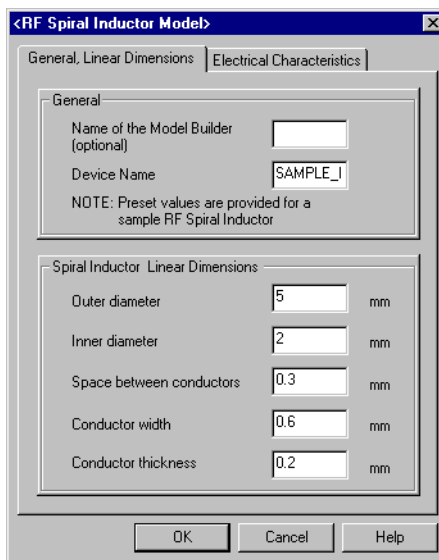
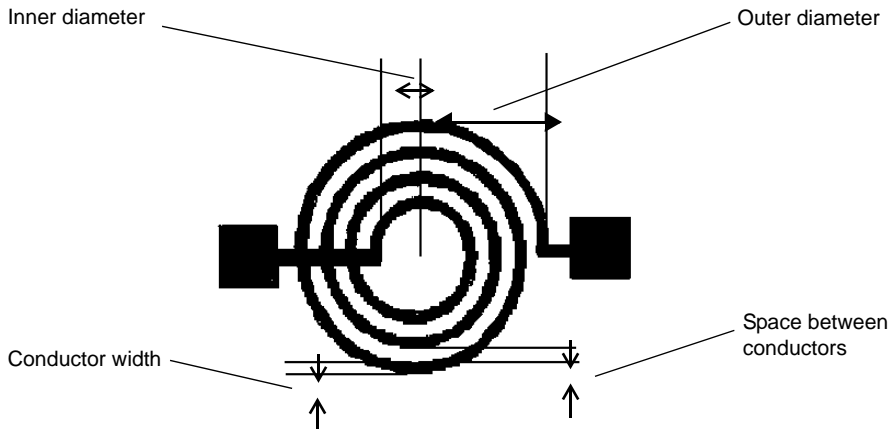

## 15.5.5 Strip Line Model

For the Strip Line models, enter values in the two tabs shown below. Use the following diagram for assistance in identifying the values:

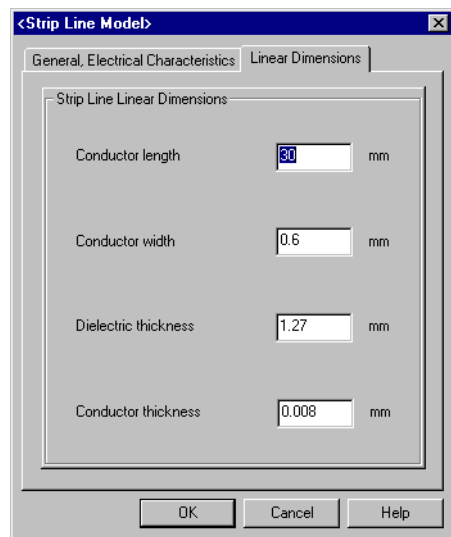
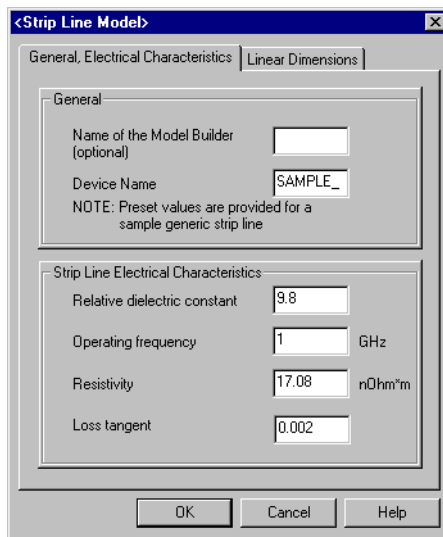
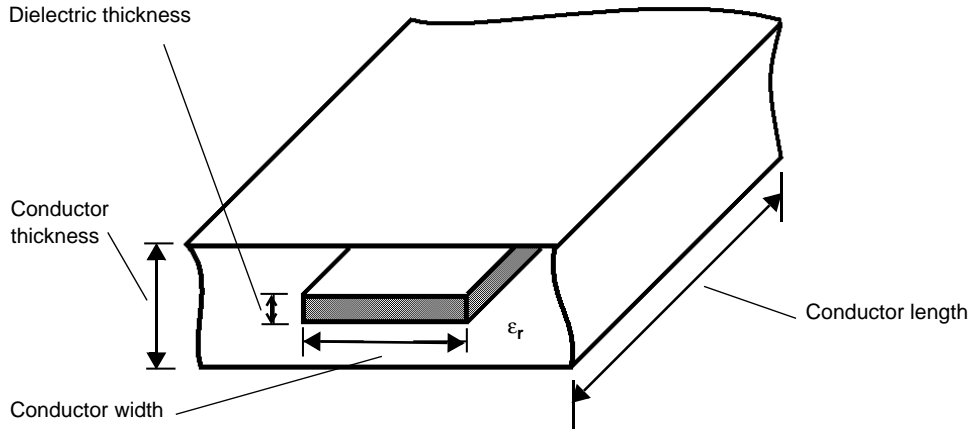

## 15.5.6 Stripline Bend

For the Stripline Bend models, enter values in the two tabs shown below. Use the following diagram for assistance in identifying the values (refer to the Stripline diagram in “15.5.5 Strip Line Model” on page 15-35 for Relative dielectric constant ( $\epsilon_r$ ), Dielectric thickness and Conductor thickness):

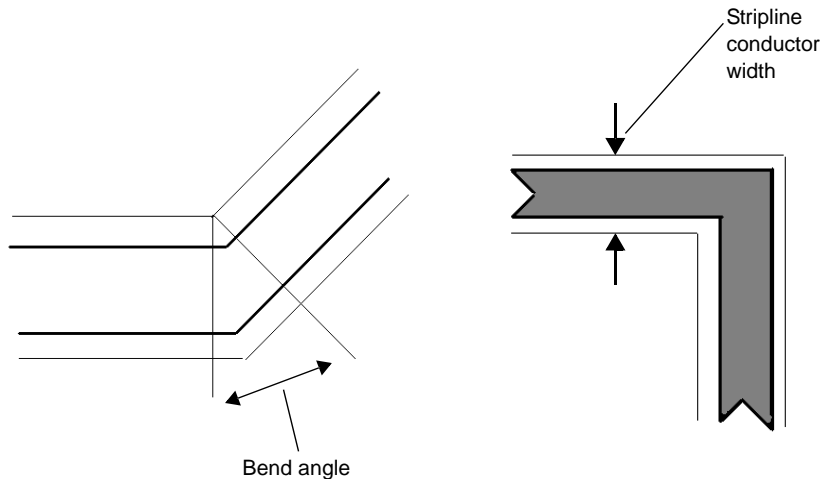

<Stripline Bend Model>

General, Electrical Characteristics | Linear Dimensions

General

Name of the Model Builder (optional)

Device Name

NOTE: Preset values are provided for a sample generic stripline bend

Strip Line Bend Electrical Characteristics

Relative dielectric constant

Operating frequency  GHz

Resistivity  nOhm\*m

Loss tangent

OK Cancel Help

<Stripline Bend Model>

General, Electrical Characteristics | Linear Dimensions

Strip Line Bend Linear Dimensions

Stripline conductor width  mm

Bend angle  deg.

Dielectric thickness  mm

Conductor thickness  mm

OK Cancel Help

## 15.5.7 Lossy Line

For Lossy Line models, enter values in the two tabs shown below. Use the following catalogue excerpt for assistance in identifying the values:

**Belden** 50 Ohm Transmission Cable  
RG-188A/U QPL  
26 AWG  
1-800-BELDEN-1

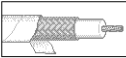

Phase velocity

Characteristic impedance

Line length

Nominal attenuation @ lower frequency bound

Nominal attenuation @ higher frequency bound

Trade Number Industry Stds.	Std. Lgth. (ft.)	Std. Units (lbs.)	AVG (stranuj) Type (dia.) Nom. D.C.R.	Core O.D. Nom. O.D.	Shields Nom. D.C.R.	Nom. Imp. (ohms)	Vel. of Prop.	Nom. Cap.
83269	100	1.4	26 (7x.0067)	0.058 in.	96% SC Braid	50.0	69.5%	29.2 pF/m
	500	6.4	SCCCS 0.02 in.	0.108 in.	Inner			
	1000	12.4	84.1 ohms/MF		8.5 ohms/MF			
Metric	(Meters)	(Kg)		1.473 mm	Inner			95.8 pF/m
	30.5	.64	.508 mm	2.743 mm				
	152.4	2.9	275.8 ohms/km		27.9 ohms/km			
	304.9	5.6						

**Description:**

**Insulation:** TFE Teflon

**Jacket:** TFE Teflon Tape

**Plenum Version(s):** n/a

Coaxial High Temperature MIL-C-17 Cable. 26 AWG stranded silver coated copper coated steel (SCCCS) conductor with TFE Teflon® insulation. Silver coated copper braid, 96% coverage. White TFE Teflon® tape jacket. MIL-C-17D Temperature Rating: 200°C. Suggested Operating Temperature Range (Non-UL): -70°C to +200°C. Maximum Operating Voltage (Non-UL): 900 Volts RMS. Passes VW-1 Vertical Wire Flame Test. For cables manufactured to the latest government revision of other MIL-SPEC requirements, please contact your nearest Belden® Regional Sales Office. Spools may contain more than one piece. Lengths may vary ±10% from length shown.

Freq MHz	Attenuation		1000.0	29.0	95.1
	Nom. Atten. (dB/100ft)	Nom. Atten. (dB/100m)			
1.0	1.2	3.93			
10.0	2.7	8.85			
50.0	5.5	18.36			
100.0	8.3	27.2			
200.0	12.0	39.3			
400.0	17.5	57.4			
700.0	23.7	77.7			
900.0	27.3	89.5			



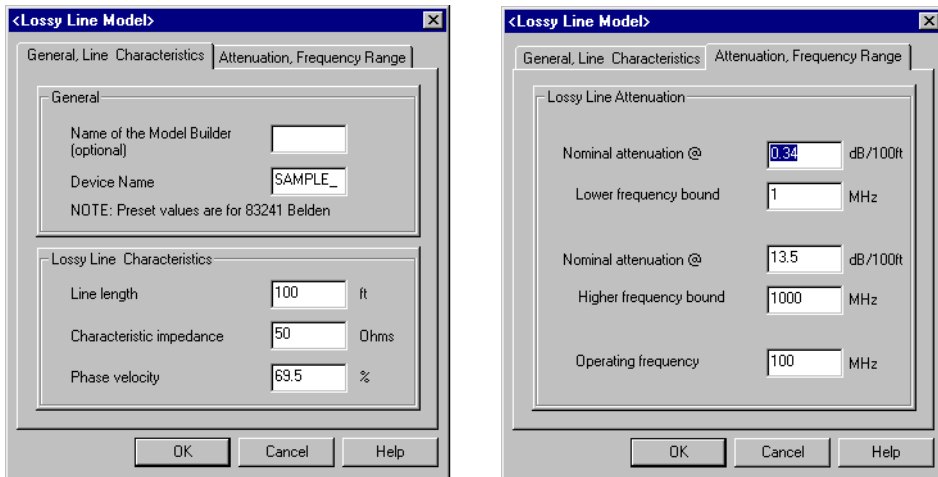

## 15.5.8 Interdigital Capacitor

For Interdigital Capacitor models, enter values in the two tabs shown below. Use the following diagram for assistance in identifying the values:

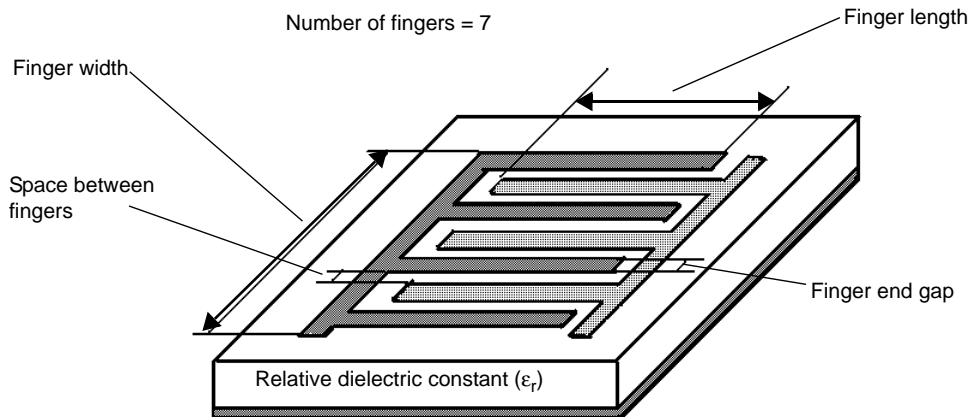

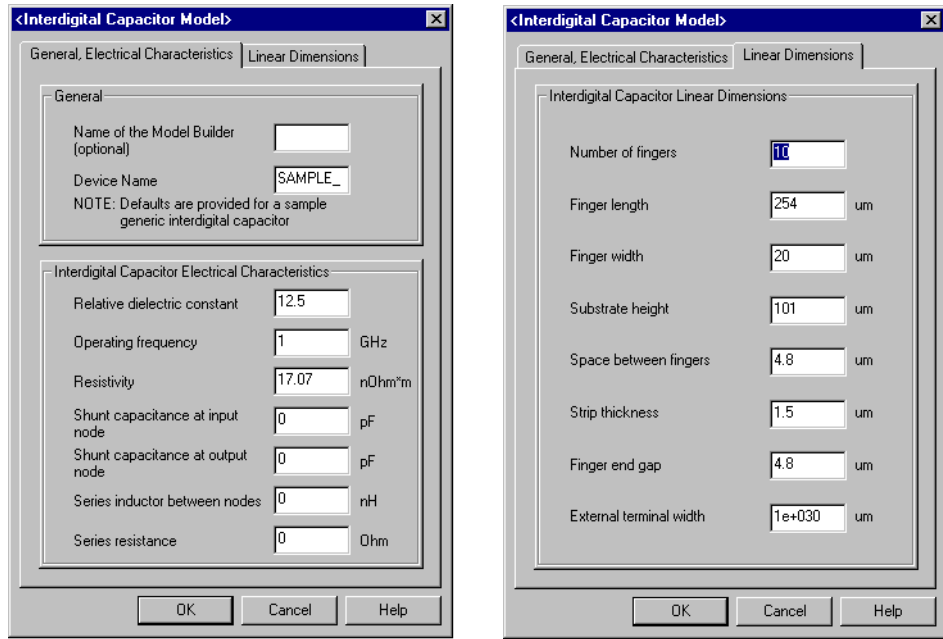

## 15.6 Tutorial: Designing RF Circuits

This tutorial is intended to:

- provide an introduction to simple RF circuit design
- demonstrate to engineers how to use Multisim for designing an RF circuit. Each design step is accompanied by the required simulation steps in Multisim.

The methodology that an RF engineer uses to design an RF circuit differs from that used for a low-frequency circuit design. An RF designer looks at performance parameters such as S-parameters, input/output impedances, power gain, noise figure, and stability factor. These design parameters are not directly available from a SPICE simulation. Impedance matching is a phase of RF circuit designs where the designer uses a Smith Chart, and calculates the values of matching elements such that maximum power is transferred to the load impedance. The Smith Chart or the calculations are not provided by SPICE simulation.

## 15.6.1 Selecting Type of RF Amplifier

Select the type of amplifier based on the application. Amplifiers designed for low-power applications are different than those for low-noise applications. Similarly, broad-band amplifiers are different in terms of design and structure than those for high-gain amplifiers. Some of the possible applications are:

- **Maximum Power Transfer** — These types of amplifiers operate in a very narrow band of frequencies.
- **Design for Specified Gain** — Designers may intentionally introduce mismatching at the input and/or the output ports to improve the bandwidth, even though the resulting power transfer is not maximal.
- **Low-Noise Amplifier Design** — In receiver applications, you need a pre-amplifier with as low a figure noise as possible since the first stage of a receiver front end has a dominant effect on the noise performance of the overall system. It is not possible to obtain both minimum noise figure and maximum gain for an amplifier.
- **Oscillators** — To produce a sinusoidal steady-state RF signal, you can use active elements and intentionally introduce negative resistance.

The network analyzer provided by Multisim is not intended for high-power RF amplifiers, because the network analyzer performs small-signal analyses of the RF network only.

In this tutorial, we will design the amplifier for maximum power transfer. Then, we will provide design steps for constant gains.

- To prepare for the tutorial, open a new circuit window.

## 15.6.2 Selecting an RF Transistor

Different types of transistors are designed for a broad range of applications. For example, you may find many transistors for low noise applications. Cost of the transistor plays a significant role in choosing from those offered. In this tutorial, we will choose MRF927T1 because it is used for low power, low noise applications at relatively high frequencies.

- To select the MRF927T1 transistor in Multisim, do the following:



1. Click the **RF** button in the **Component** toolbar.
2. Select the **RF\_BJT\_NPN** family in the **Select a Component** browser.
3. Scroll down in the component list until you find MRF927T1 and select it. Component data for that component appears in the dialog box.
4. Click **OK**. The browser closes and your cursor changes to indicate a transistor is ready to be placed.

5. Click to place the transistor on the circuit window. The results look similar to this:

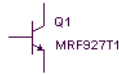

### 15.6.3 Selecting a DC-operating Point

DC-operating point is referred to as  $V_{ce}$  and  $I_c$ . There are many reasons to select a specific DC-operating point. You need to consider “maximum swing” at the output, small/portable power source, and gain-bandwidth. Some DC-operating points are available in the data book, and others must be decided based on the application.

#### Vce Settings

$V_{ce}$  is always less than  $V_{cc}$ , and it is usually around  $V_{cc}/2$  for maximum swing in a common-emitter configuration. For this tutorial  $V_{ce}=3V$  and  $V_{cc}=9V$  are selected.

#### Ic Settings

The nominal value of  $I_c$  for the selected transistor is 5mA. The power dissipated in the transistor at any time is  $I_c \cdot V_{ce}$ . For this tutorial,  $I_c=3mA$  is selected to dissipate less power and to be close to the nominal value of  $I_c$ . This will let us achieve relatively good current-gain bandwidth and moderate voltage gain. (The voltage gain is maximum at  $I_c=1mA$  and the current gain-bandwidth is maximum at  $I_c=5mA$ .)

### 15.6.4 Selecting the Biasing Network

There are a number of possible structures to select from for proper DC-biasing of the network. It is important to note that the performance of the transistor and the amplifiers depends on DC-operating points. The following figure shows one possible biasing network.

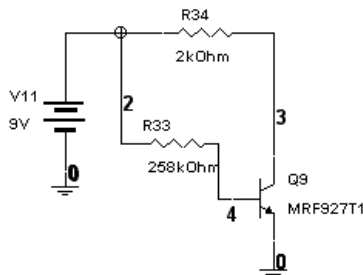

This is the simplest structure for a biasing network. However, its thermal stability is poor. To find the resistor values for this structure you need to know five values:  $V_{ce}$ ,  $I_c$ ,  $V_{cc}$ ,  $V_{be}$ , and  $\beta$  (which is the DC-current gain of the transistor and is given in most data books).  $\beta$  relates  $I_c$  to  $I_b$  as  $\beta = I_c/I_b$ .  $V_{be}$  is the base-emitter voltage of the transistor when it is active, and is typically 0.7 V. Both  $\beta$  and  $V_{be}$  depend on the values of  $I_c$  and  $I_b$ . The initial design process starts with typical values of  $R_c$  and  $R_b$  in the structure shown above. However, if accuracy is critical, you should use Multisim to ensure that the values of  $I_c$  and  $V_{ce}$  are as intended. In this tutorial, these selections are used:

- $V_{ce} = 3 \text{ V}$
- $I_c = 3 \text{ mA}$
- $V_{cc} = 9 \text{ V}$
- $V_{be} = 0.7 \text{ V}$
- $\beta = 100$ .

The initial values of  $R_c$  and  $R_b$  are calculated as shown below.

$$R_c = (V_{cc} - V_{ce})/I_c = (9 \text{ V} - 3 \text{ V})/3 \text{ mA} = 2 \text{ KOhm}$$

$$I_b = I_c/\beta = 3 \text{ mA}/100 = 30 \mu\text{A}$$

$$R_b = (V_{cc} - V_{be})/I_b = (9 \text{ V} - 0.7 \text{ V})/30 \mu\text{A} = 277 \text{ KOhm}$$

➤ To select the DC operating points:

1. Draw the circuit shown above with  $R_b=277 \text{ KOhm}$  and  $R_c=2 \text{ KOhm}$ . Note that  $V_{cc}=9 \text{ V}$  and the transistor is MRF927T1.



2. Click the **Analysis** button and choose **DC Operating Point**. The **DC Operating Point Analysis** dialog box appears.

3. Select the nodes representing the collector and base of the transistor.

4. Click **Plot during Simulation**.

5. Click **Simulate**.

The results will show a reading of  $V_c$  and  $V_b$ . In the DC-biasing network,  $V_c$  is  $V_{ce}$  and  $V_b$  is  $V_{be}$ . The first readings are  $V_{ce}=3.33 \text{ V}$  and  $V_{be}=0.8 \text{ V}$ . You can modify the value of either  $R_c$  or  $R_b$  or both, to achieve the desired DC operating point. After a number of iterations, you arrive at  $R_c=2 \text{ KOhm}$  and  $R_b=258 \text{ KOhm}$ . Reading the values of  $V_{ce}$  and  $V_{be}$  for the final simulation, you will note that

$$\beta = I_c/I_b = R_b \cdot (V_{cc} - V_{ce}) / [R_c \cdot (V_{cc} - V_{be})] = 94.36$$

which is close to the initial value of  $\beta$ .

### 15.6.4.1 Selecting an Operating Frequency Point

The operating frequency point chosen depends on the type of application, and is usually defined in the design specifications. For this tutorial, you can assume a single (center) frequency analysis of 3.02 GHz.

### 15.6.4.2 Analyzing the RF Network

➤ To perform the simulation:

1. Connect the biased transistor to the network analyzer using two series capacitors. These capacitors are used to isolate the network analyzer from the biasing network in DC mode. This step is necessary whenever the biasing network is important, that is, for active circuits only.

The connection should look like this:

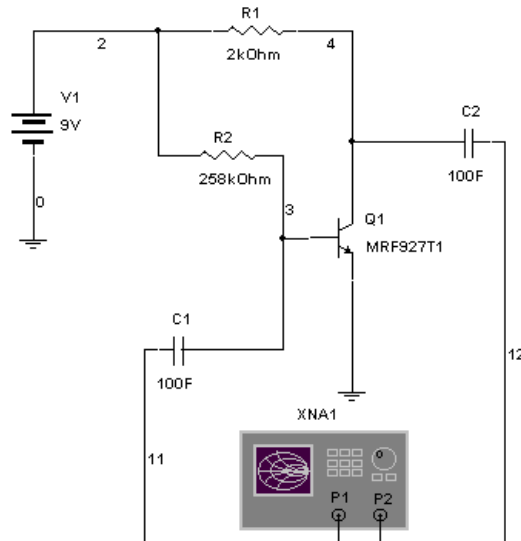

2. Choose **Simulate/Run** and wait until the AC analyses are complete. Ignore the warning for DC analyses.
3. Double-click on the Network Analyzer icon on circuit window and click the **Match Net. Designer** button.
4. In the **Match Net. Designer** dialog box that appears, do the following:
  - set the frequency to 3.02 GHz
  - since the circuit is “unconditionally stable” for this frequency point, click **Impedance Matching**

- since the circuit is “unconditionally stable”, automatic impedance matching is possible. Enable **Auto Match**.

The dialog box provides the structure and the values necessary for conjugate matching. Hence, maximum power transfer is achieved.

Below is our design for maximum power transfer at  $f=3.02$  GHz:

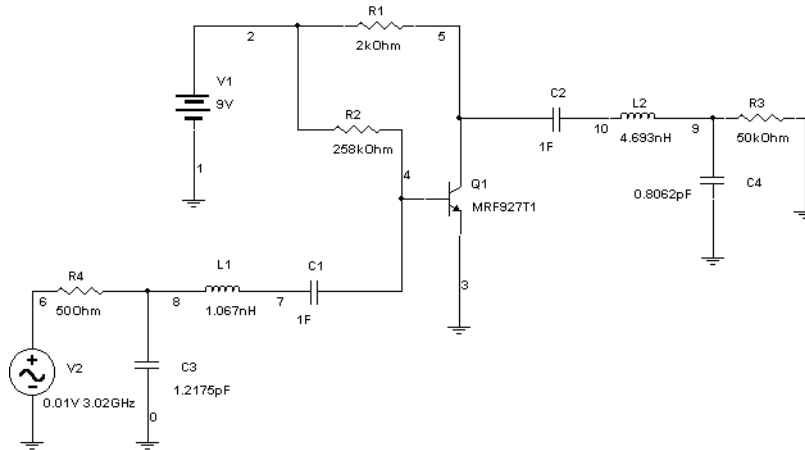

**Note** 1F is needed to isolate the active network from its matching network to keep the transistor in its biasing state.

Impedance matching yields maximum power transfer for a very narrow bandwidth. In real applications, however, you need to balance the power transfer and the bandwidth. For this reason, mismatching is intentionally introduced to the circuit.

- To design the amplifier for a constant gain less than the maximum possible gain, for better frequency response:
  1. Open the DC biased transistor circuit discussed previously.
  2. Open the network analyzer and change settings as follows:
    - click **RF Characterizer**
    - select “Power Gains” from the **Param** drop-down list
    - select “dB MAG” from the **Marker** drop-down list
    - set the frequency to 3.02 GHz
    - click **TPG** (Transducer Power Gain) under **Trace** and set its value to 4.3652 dB for our example.
  3. Click **Match Net. Designer** and, in the **Match Net. Designer** dialog box, select the Unilateral Gain Circles tab.
  4. Change the value of  $G_s$  and  $G_l$  manually and individually until the circles become a dot on the Smith Chart. The example shows  $G_s=0.042$  dB and  $G_l=1.2650$  dB.

5. Calculate the maximum transferable power.  $P_{max} = 0.042 + 4.3652 + 1.2650 = 5.6722$  dB.
6. Select the gain desired. This gain should be less than 5.6752 dB. 3.5302 dB was selected as the power gain.
7. Choose  $G_s$  and  $G_l$  so that  $G_s + 4.3652 + G_l = 3.5302$  dB and  $G_s < 0.042$  dB and  $G_l < 1.2650$  dB. You selected  $G_s = -0.08350$  dB and  $G_l = 0$  dB.
8. Enter the selected values for  $G_s$  and  $G_l$  and observe the circles. Select point or points on the circles which are closest to the center of the Smith Chart. The circle for  $G_l = 0$  dB always passes through the center. Therefore, the best point of the  $G_l$  is the center itself. This means that 50 Ohm load is sufficient to produce  $G_l = 0$  dB. The best point on  $G_s$  for the example is  $Z_l = 2$  (normalized). Using this value, you can design the matching network at the input port of the amplifier. You must make sure that the selected point or points are stable. Therefore, it is recommended that you go back to “Stability Circles”, and confirm the stability of the design. Since the amplifier is unconditionally stable, it would be stable for any passive load or source network. Hence, you need not check the stability circles.

The complete amplifier is shown in the following figure:

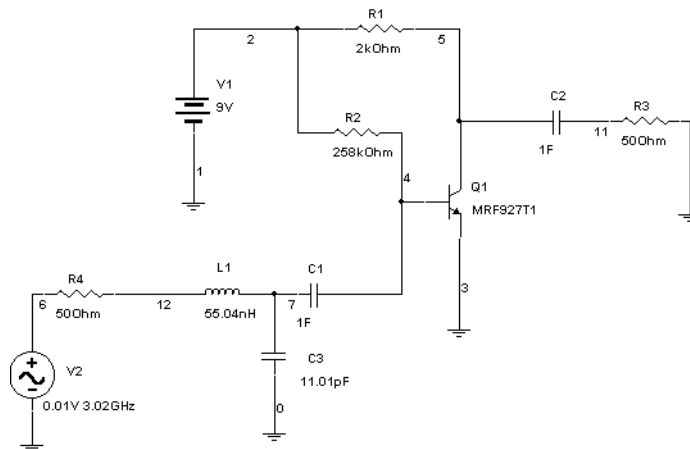

**Note** The matching elements are calculated manually in this example.



# Appendix A

This section contains brief descriptions for the commands in the Multisim 9 menus.

## A.1 Multisim Menu

The following menus are found in Multisim.

- File Menu
- Edit Menu
- View Menu
- Place Menu
- Simulate Menu
- Transfer Menu
- Tools Menu
- Reports Menu
- Options Menu
- Window Menu
- Help Menu

### A.1.1 File Menu

The File menu contains commands for managing circuit files created with Multisim.

#### A.1.1.1 File/New/Schematic Capture

Opens an untitled circuit window that can be used to create a circuit. The new window opens using your default circuit preferences. Until you save, the circuit window is named “Circuit#”, where “#” is a consecutive number. For example, “Circuit1”, “Circuit2”, “Circuit3”, and so on.

---

### A.1.1.2 File/Open

Opens a previously created circuit file or netlist. Displays a file browser. If necessary, change to the location of the file you want to open. You can also open Ulticap and Orcad files. For details, see “14.7 Importing Files with Other Formats” on page 14-8.

**Note** You can open files created with Version 5 of Electronics Workbench, and files created in previous versions Multicap, Multisim and netlist files.

### A.1.1.3 File/Open Samples

Opens a folder containing sample and tutorial files.

### A.1.1.4 File/Close

Closes the active circuit file. If any changes were made since the last save of the file, you are prompted to save those changes before closing.

### A.1.1.5 File/Close All

Closes all circuit files. If any changes were made since the last save of the file, you are prompted to save those changes before closing.

### A.1.1.6 File/Save

Saves the active circuit file. If this is the first time the file is being saved, displays a file browser. If you want, change to the desired location for saving the file. You can save a circuit file with a name of any length.

The extension `.ms9` is added to the file name automatically. For example, a circuit named `Mycircuit` will be saved as `Mycircuit.ms9`.

**Tip** To preserve the original circuit without changes, choose **File/Save As**.

### A.1.1.7 File/Save As

Saves the current circuit with a new file name. The original circuit remains unchanged.

**Tip** Use this command to experiment safely on a copy of a circuit, without changing the original.

### A.1.1.8 File/Save All

Saves all open circuit files.

### **A.1.1.9 File/New Project**

Creates a new project for grouping together related circuit designs. For details, see “6.6.1 Setting up Projects” on page 6-48.

### **A.1.1.10 File/Open Project**

Opens an existing project. For details, see “6.6.2 Working with Projects” on page 6-49.

### **A.1.1.11 File/Save Project**

Saves a project. For details, see “6.6.2 Working with Projects” on page 6-49.

### **A.1.1.12 File/Close Project**

Closes an open project. For details, see “6.6.2 Working with Projects” on page 6-49.

### **A.1.1.13 File/Version Control**

Backs up or restores a project. For details, see “6.6.4 Version Control” on page 6-51.

### **A.1.1.14 File/Print**

Opens a standard **Print** dialog box. For details, see “4.12 Printing the Circuit” on page 4-62.

### **A.1.1.15 File/Print Preview**

Previews the circuit as it will be printed. Opens a separate window, where you can move from page to page and zoom in for details. You can also print what you preview. For details, see “4.12 Printing the Circuit” on page 4-62.

### **A.1.1.16 File/Print Options/Printer Setup**

Changes the printer, paper size, paper source and page orientation for a selected printer.

**Note** If you change the page orientation using the **Print Setup** dialog box that displays here, the change is also reflected in the **Print Circuit Setup** dialog box.

### **A.1.1.17 File/Print Options/Print Circuit Setup**

Allows you to set the page margins, page orientation (landscape or portrait), zoom level and output options.

These settings apply only to the current circuit. For details on these fields see “4.12 Printing the Circuit” on page 4-62.

---

**Note** If you change the page orientation using the **Page Circuit Setup** dialog box, the change is also reflected in the **Print Setup** dialog box.

### **A.1.1.18 File/Print Options/Print Instruments**

Prints the faces of any or all of the instruments in your circuit. For details, see “10.2 Printing Instruments” on page 10-7.

### **A.1.1.19 File/Recent Circuits**

Displays a list of the eight most recently saved circuit files. To re-open a file, select it from the list.

### **A.1.1.20 File/Recent Projects**

Displays a list of the eight most recently saved projects. To re-open a project, select it from the list.

### **A.1.1.21 File/Exit**

Closes all open circuit windows and exits Multisim. If you have unsaved changes in any circuits, you are prompted to save or cancel them.

## **A.1.2 Edit Menu**

Contains commands for removing, duplicating or selecting information. If a command is not applicable to the selected item (for example, a component), it is dimmed.

### **A.1.2.1 Edit/Undo**

Undoes the most recently performed delete.

### **A.1.2.2 Edit/Redo**

Redoes the most recently performed undo.

### **A.1.2.3 Edit/Cut**

Removes selected components, circuits or text. What you cut is placed on the Windows clipboard so you can paste it elsewhere.

### A.1.2.4 Edit/Copy

Copies selected components, circuits or text. The copy is placed on the Windows clipboard. You can then use the **Paste** command to paste the copy elsewhere, including other applications such as word processors.

### A.1.2.5 Edit/Paste

Places the contents of the clipboard. The cursor shows a “ghosted” image of the item to be pasted. Click to indicate where the item is to be pasted.

### A.1.2.6 Edit/Delete

Permanently removes selected components or text. Does not place the selection on the clipboard and does not affect anything currently on the clipboard.

---

**Caution** Use the Delete command with care. Deleted information cannot be retrieved, although a delete, or any other action, can be recovered using the Undo command.

---

### A.1.2.7 Edit/Select All

Selects all items in the active circuit window.

**Tip** To select all but a few items, use the **Select All** command and then deselect the ones you don't want by SHIFT-clicking.

### A.1.2.8 Edit/Delete Multi-Page

Displays the **Delete Multi-Page** dialog box where you select the page to be removed from a multi-page circuit file. For details, see “6.1.1 Delete Multi-page Dialog Box” on page 6-3.

---

**Caution** Use the Delete Multi-Page command with care. Deleted information cannot be retrieved, although a delete, or any other action, can be recovered using the Undo command.

---

### A.1.2.9 Edit/Paste as Subcircuit

Pastes the selection on the clipboard as a subcircuit. For details on subcircuits, see “6.2 Hierarchical Design” on page 6-3.

---

### **A.1.2.10 Edit/Find**

Displays the **Find Component** dialog box. For details, see “4.8 Finding Components in Your Circuit” on page 4-32.

### **A.1.2.11 Edit/Graphic Annotation**

Shows various graphic annotation options.

#### **Edit/Graphic Annotation/Pen Color**

Displays a palette where you can change the color of lines for graphic elements, excluding placed text.

#### **Edit/Graphic Annotation/Pen Style**

Displays options for the appearance of lines for graphics elements, excluding placed text.

#### **Edit/Graphic Annotation/Fill Color**

Displays a palette where you can change the fill color of graphic elements like rectangles.

#### **Edit/Graphic Annotation/Fill Type**

Displays options for the appearance of the fill of graphic elements like rectangles.

#### **Edit/Graphic Annotation/Arrow**

Displays available arrows used to end lines and other graphic elements.

### **A.1.2.12 Edit/Order**

Use to either send a selected graphic item to the back, or bring it to the front.

### **A.1.2.13 Edit/Assign to Layer**

Assigns the selected item to an annotation layer. For details, see “3.5.1 Visibility Tab” on page 3-34.

### **A.1.2.14 Edit/Layer Settings**

Displays the **Visibility** dialog box. The settings found in this dialog box are also found in the **Visibility** tab of the **Sheet Preferences** dialog box. For details, see “3.4.2.6 Sheet Properties - Visibility Tab” on page 3-33.

### **A.1.2.15 Edit/Title Block Position**

Contains options for locating the title block on the sheet.

#### **Edit/Title Block Position/Title Block Bottom Left**

Places the title block at the bottom left of the sheet.

#### **Edit/Title Block Position/Title Block Bottom Right**

Places the title block at the bottom right of the sheet.

#### **Edit/Title Block Position/Title Block Top Left**

Places the title block at the top left of the sheet.

#### **Edit/Title Block Position/Title Block Top Right**

Places the title block at the top right of the sheet.

### **A.1.2.16 Edit/Orientation**

Shows options for changing the orientation of selected elements.

#### **Edit/Orientation/Flip Horizontal**

Flips the selection horizontally. For details, see “4.7 Rotating/Flipping Placed Components” on page 4-30.

#### **Edit/Orientation/Flip Vertical**

Flips the selection vertically. For details, see “4.7 Rotating/Flipping Placed Components” on page 4-30.

#### **Edit/Orientation/90 Clockwise**

Rotates the selection 90 degrees clockwise. For details, see “4.7 Rotating/Flipping Placed Components” on page 4-30.

#### **Edit/Orientation/90 CounterCW**

Rotates the selection 90 degrees counter-clockwise. For details, see “4.7 Rotating/Flipping Placed Components” on page 4-30.

### **A.1.2.17 Edit/Symbol/Title Block**

Use to do an in-place edit of a selected component’s symbol, or a selected title block.

---

### **A.1.2.18 Edit/Font**

Displays the **Font** dialog box, where you can change various font properties. Contains the same information as the **Font** tab in the **Sheet Properties** dialog box. For details, see “3.4.2.4 Sheet Properties - Font Tab” on page 3-30.

### **A.1.2.19 Edit/Comment**

Use to edit the contents of a selected comment. See also, “4.9.5 Adding a Comment” on page 4-40.

### **A.1.2.20 Edit/Forms**

Displays the **Edit Form** dialog box where you enter and edit questions related to the circuit. For details, see “4.11 Linking a Form to a Circuit” on page 4-59.

### **A.1.2.21 Edit/Properties**

Opens the properties dialog box of the item selected in the active window. If there is no item selected, the **Sheet Properties** dialog box displays.

## **A.1.3 View Menu**

Contains commands for displaying and hiding elements of the circuit window such as the grid, toolbars and page boundaries.

### **A.1.3.1 View/Full Screen**

Shows the workspace without any toolbars or menu items showing.

### **A.1.3.2 View/Parent Sheet**

Use to view the active subcircuit or hierarchical block’s parent sheet. For details, see “6.2.7 Viewing Parent Sheet” on page 6-11.

### **A.1.3.3 View/Zoom In**

Lets you increase the magnification of your view of the circuit.

### **A.1.3.4 View/Zoom Out**

Lets you decrease the magnification of your view of the circuit.



### **A.1.3.5 View/Zoom Area**

Lets you zoom in on selected components when the workspace is displayed at less than 100%.

### **A.1.3.6 View/Zoom Fit to Page**

Lets you display your entire circuit on the workspace at once.

### **A.1.3.7 View/ Show Grid**

Shows or hides a grid in the background of the circuit window. This helps you place elements in specific locations on a grid.

### **A.1.3.8 View/Show Border**

Shows or hides the circuit's border.

### **A.1.3.9 View/Show Page Bounds**

Shows or hides page boundaries in the circuit window. This helps you note where circuits will appear on printed output.

### **A.1.3.10 View/Ruler Bars**

Shows or hides the ruler bars on the top and left margins that appear outside of the workspace.

### **A.1.3.11 View/Status Bar**

Shows or hides the status bar at the bottom of the workspace.

### **A.1.3.12 View/Design Toolbox**

Shows or hides the **Design Toolbox**. For details, see “3.5 Design Toolbox” on page 3-34.

### **A.1.3.13 View/Spreadsheet View**



Select/deselect to show/hide the **Spreadsheet View**. For details, see “5.2 The Spreadsheet View” on page 5-9.

### **A.1.3.14 View/Circuit Description Box**

Opens a window in which you can enter comments or information about the circuit. For details, see “4.10 Circuit Description Box” on page 4-47.

---

## A.1.3.15 View/Toolbars

Shows or hides the selected toolbar. Choose to show or hide any or all of the toolbars discussed below. For information on these toolbars, see “A.1 Multisim Menus” on page A-1.

### View/Toolbars/Standard

Select/deselect to show/hide the **Standard** toolbar.

### View/Toolbars/View

Select/deselect to show/hide the **View** toolbar.

### View/Toolbars/Main

Select/deselect to show/hide the **Main** toolbar.

### View/Toolbars/Graphic Annotation

Select/deselect to show/hide the **Graphic Annotation** toolbar.

### View/Toolbars/3D Components

Select/deselect to show/hide the **3D Components** toolbar. You can place virtual 3D components from this toolbar.

### View/Toolbars/Analog Components

Select/deselect to show/hide the **Analog Components** toolbar. You can place virtual analog components from this toolbar.

### View/Toolbars/Basic

Select/deselect to show/hide the **Basic** toolbar. You can place virtual basic components from this toolbar.

### View/Toolbars/Diodes

Select/deselect to show/hide the **Diodes** toolbar. You can place virtual diodes from this toolbar.

### View/Toolbars/Transistor Components

Select/deselect to show/hide the **Transistor Components** toolbar. You can place virtual transistors from this toolbar.

### View/Toolbars/Measurement Components

Select/deselect to show/hide the **Measurement Components** toolbar. You can place virtual measurement components from this toolbar.

### **View/Toolbars/Miscellaneous Components**

Select/deselect to show/hide the **Miscellaneous Components** toolbar. You can place miscellaneous virtual components from this toolbar.

### **View/Toolbars/Components**

Select/deselect to show/hide the **Component** toolbar.

### **View/Toolbars/Power Source Components**

Select/deselect to show/hide the **Power Source Components** toolbar. You can place virtual power source components from this toolbar.

### **View/Toolbars/Rated Virtual Components**

Select/deselect to show/hide the **Rated Virtual Components** toolbar. You can place rated virtual components from this toolbar.

### **View/Toolbars/Signal Source Components**

Select/deselect to show/hide the **Signal Source Components** toolbar. You can place virtual signal source components from this toolbar.

### **View/Toolbars/Virtual**

Select/deselect to show/hide the **Virtual** toolbar, which is used to place virtual components. For details, see “4.4.2 Placing Virtual Components” on page 4-9.

### **View/Toolbars/Instrument Toolbar**

Select/deselect to show/hide the Instrument toolbar.

### **View/Toolbars/Description Edit Bar**

Select/deselect to show/hide the **Description Edit Bar**. This toolbar is used to edit the **Circuit Description Box**. For details see, “4.10 Circuit Description Box” on page 4-47.

### **A.1.3.16 View/Comment/Probe**

Shows or hides information boxes for selected comments or static probes. For details, see “4.9.5 Adding a Comment” on page 4-40 and “10.15 Measurement Probe” on page 10-40.

### **A.1.3.17 View/Grapher**

Shows or hides the **Grapher**, which shows the results of simulation on a graph or chart. For details about this feature, see “11.2 Viewing the Analysis Results: Grapher” on page 11-4.

---

## A.1.4 Place Menu

Contains commands for placing elements in the circuit window.

### A.1.4.1 Place/Component

Lets you browse the databases (**Master Database**, **Corporate Database** and **User Database**) for components to be placed. For details, see “4.4.1 Using the place component browser” on page 4-4.

### A.1.4.2 Place/Junction

Places a junction where you click. For details, see “4.6 Manually Adding a Junction (Connector)” on page 4-29.

### A.1.4.3 Place/Wire

Use to place a wire on the workspace that is not connected to any component. For details, see “4.5.5 Placing Wires Directly Onto Workspace” on page 4-26.

### A.1.4.4 Place/Bus

Places a bus with segments created as you click. For details, see “6.4 Buses” on page 6-16.

### A.1.4.5 Place/Connectors

Lets you place various connectors on the workspace.

#### **Place/Connectors/HB/SC Connector**

Adds connecting nodes to a circuit for use in a hierarchical block or a subcircuit.

#### **Place/Connectors/Off-Page Connector**

Places an off-page connector on your workspace. For details, see “6.1 Flat Multi-sheet Design” on page 6-2.

#### **Place/Connectors/Bus HB/SC Connector**

Places a bus connector between the main circuit and a hierarchical block or subcircuit. For details, see “6.4.1.2 Connecting Buses to HB/SCs” on page 6-19.

## **Place/Connectors/Bus Off-Page Connector**

Places a bus connector between the main circuit and a multi-page. For details, see “6.4.1.1 Placing a bus across Multi-pages” on page 6-19.

## **A.1.4.6 Place/Hierarchical Block from File**

Places a circuit in a hierarchical structure. For details, see “6.2.5.1 Placing a HB from an Existing File” on page 6-8.

## **A.1.4.7 Place/New Hierarchical Block**

Places a circuit without any components in a hierarchical structure. For details, see “6.2.5 Adding a Hierarchical Block” on page 6-7.

## **A.1.4.8 Place/Replace by Hierarchical Block**

Replaces the elements that you have selected with a hierarchical block. See “6.2.5.2 Replacing Components with an HB” on page 6-9.

## **A.1.4.9 Place/New Subcircuit**

Places a subcircuit without any components. For details, see “6.2.6 Adding a Subcircuit” on page 6-9.

## **A.1.4.10 Place/Replace by Subcircuit**

Replaces the selected components with a subcircuit containing those components. For details, see “6.2.6 Adding a Subcircuit” on page 6-9.

## **A.1.4.11 Place/Multi-Page**

Opens a new flat page. For details, see “6.1 Flat Multi-sheet Design” on page 6-2.

## **A.1.4.12 Place/Merge Bus**

Merges two buses together. For details, see “6.4.3 Merging Buses” on page 6-24.

## **A.1.4.13 Place/Bus Vector Connect**

This is the preferred method for placing numerous connections from a multi-pinned device, such as an IC, to a bus. For details, see “6.4.5 Bus Vector Connect” on page 6-27.

---

### **A.1.4.14 Place/Comment**

Use to “pin” a comment to the workspace, or directly to a component. When a component with an attached comment is moved, the comment also moves. For details, see “4.9.5 Adding a Comment” on page 4-40.

### **A.1.4.15 Place/Text**

Lets you place text on the circuit. For details, see “4.9.4 Adding Miscellaneous Text” on page 4-39.

### **A.1.4.16 Place/Graphics**

Lets you place any of the graphic elements mentioned below.

#### **Place/Graphics/Line**

Places a straight line on your workspace. For details, see “4.9.6 Graphic Annotation” on page 4-43.

#### **Place/Graphics/Multiline**

Places a multiline on your workspace. For details, see “4.9.6 Graphic Annotation” on page 4-43.

#### **Place/Graphics/Rectangle**

Places a rectangle on your workspace. For details, see “4.9.6 Graphic Annotation” on page 4-43.

#### **Place/Graphics/Ellipse**

Places an ellipse on your workspace. For details, see “4.9.6 Graphic Annotation” on page 4-43.

#### **Place/Graphics/Arc**

Places an arc on your workspace. For details, see “4.9.6 Graphic Annotation” on page 4-43.

#### **Place/Graphics/Polygon**

Places a polygon on your workspace. For details, see “4.9.6 Graphic Annotation” on page 4-43.

#### **Place/Graphics/Picture**

Places a picture on your workspace. For details, see “4.9.6 Graphic Annotation” on page 4-43.

### A.1.4.17 Place/Title Block

Lets you place a title block on your workspace. For details, see “4.9.3 Adding a Title Block” on page 4-36.

## A.1.5 Simulate Menu

### A.1.5.1 Simulate/Run

Runs/stops the simulation of the active circuit. Running a simulation initializes the circuit, performs the circuit simulation and displays the results on the instrument or grapher.

### A.1.5.2 Simulate/Pause

Pauses/resumes the current simulation.

### A.1.5.3 Simulate/Instruments

Some versions of Multisim do not include all of the instruments noted below.



Contains commands you use to place instruments (an alternative to using the Instrument toolbar). For details on these instruments, see Chapter 10, “Instruments”.

**Note** Ammeter and voltmeter instruments are available from the Indicator parts bin.

#### **Simulate/Instruments/Multimeter**

Places a multimeter on the circuit window. The multimeter is used to measure AC or DC voltage or current, resistance, or decibel loss between two nodes in a circuit. For details, see “10.4 Multimeter” on page 10-10.

#### **Simulate/Instruments/Function Generator**

Places a function generator on the circuit window. The function generator is a voltage source that supplies sine, triangular or square waves. It provides a convenient and realistic way to supply power to a circuit. For details, see “10.5 Function Generator” on page 10-14.

#### **Simulate/Instruments/Wattmeter**

Places a wattmeter on the circuit window. The wattmeter provides the combined functions of a voltmeter and an ammeter. It is used to measure the magnitude of the active power, that is, the product of the voltage difference and the current flowing through the current terminals in a circuit. For details, see “10.6 Wattmeter” on page 10-17.

---

## **Simulate/Instruments/Oscilloscope**

Places an oscilloscope on the circuit window. The dual-channel oscilloscope displays the magnitude and frequency variations of electronic signals. It can provide a graph of the voltage of one or two signals over time, or allow comparison of one waveform to another. For details, see “10.7 Oscilloscope” on page 10-18.

## **Simulate/Instruments/Four Channel Oscilloscope**

Places a four-channel oscilloscope on the circuit window. For details, see “10.16 Four-channel Oscilloscope” on page 10-47.

## **Simulate/Instruments/Bode Plotter**

Places a Bode plotter on the circuit window. A Bode plotter produces a graph of a circuit’s frequency response and is useful for analyzing filter circuits. For details, see “10.8 Bode Plotter” on page 10-23.

## **Simulate/Instruments/Frequency Counter**

Places a frequency counter on the circuit window. For details, see “10.17 Frequency Counter” on page 10-57.

## **Simulate/Instruments/Word Generator**

Places a word generator on the circuit window. A word generator sends digital words or patterns of bits into circuits as a bit stream. For details, see “10.9 Word Generator” on page 10-28.

## **Simulate/Instruments/Logic Analyzer**

Places a logic analyzer on the circuit window. A logic analyzer displays the levels of up to 16 digital signals in a circuit. It is used for fast data acquisition of logic states and advanced timing analysis to help design large systems and carry out troubleshooting. For details, see “10.10 Logic Analyzer” on page 10-31.

## **Simulate/Instruments/Logic Converter**

Places a logic converter on the circuit window. It can be attached to a circuit to derive the truth table or Boolean expression the circuit embodies, or to produce a circuit from a truth table or Boolean expression. For details, see “10.11 Logic Converter” on page 10-35.

## **Simulate/Instruments/IV Analyzer**

Places an IV analyzer on the workspace, which is used to measure current-voltage curves. For details, see “10.18 IV Analyzer” on page 10-60.



### **Simulate/Instruments/Distortion Analyzer**

Places a distortion analyzer on the circuit window. A typical distortion analyzer provides distortion measurements for audio signals in the range of 20 Hz to 100 KHz. For details, see “10.12 Distortion Analyzer” on page 10-38.

### **Simulate/Instruments/Spectrum Analyzer**

Places a spectrum analyzer on the circuit window. The spectrum analyzer is used to measure frequency versus amplitude. For details, see “10.13 Spectrum Analyzer” on page 10-40.

### **Simulate/Instruments/Network Analyzer**

Places a network analyzer on the circuit window. The network analyzer is used to measure the scattering parameters (or S-parameters) of a circuit, commonly used to characterize a circuit intended to operate at higher frequencies. For details, see “10.14 Network Analyzer” on page 10-40.

### **Simulate/Instruments/Agilent Function Generator**

Places the Agilent Technologies 33120A Function Generator on the circuit window. This is a high-performance 15 MHz synthesized function generator with built-in arbitrary waveform capability. For details, see “10.19.1 Agilent Simulated Function Generator” on page 10-71.

### **Simulate/Instruments/Agilent Multimeter**

Places the Agilent Technologies 34401A Multimeter on the circuit window. This is a 6 1/2-digit, high-performance digital multimeter. For details, see “10.19.2 Agilent Simulated Multimeter” on page 10-74.

### **Simulate/Instruments/Agilent Oscilloscope**

Places the Agilent Technologies 54622D Oscilloscope on the circuit window. This is a 2-channel +16 logic channels, 100-MHz bandwidth oscilloscope. For details, see “10.19.3 Agilent Simulated Oscilloscope” on page 10-77.

### **Simulate/Instruments/Tektronix Oscilloscope**

Places the Tektronix TDS 2024 Oscilloscope on the circuit window. For details, see “10.20 Tektronix Simulated Oscilloscope” on page 10-82.

### **Simulate/Instruments/LV Instruments**

Places a LabVIEW instrument on the workspace. For details, see “10.23 LabVIEW Instruments” on page 10-87.

---

## **Simulate/Instruments/Measurement Probe**

Using the **Measurement Probe** is a fast and easy way to check voltage and frequency readings on different nodes and pins. For details, see “10.15 Measurement Probe” on page 10-40.

### **A.1.5.4 Simulate/Interactive Simulation Settings**

Allows you to set default settings for instruments that are based on a transient analysis (such as the oscilloscope, spectrum analyzer and logic analyzer). For details, see “10.3 Interactive Simulation Settings” on page 10-8.

### **A.1.5.5 Simulate/Digital Simulation Settings**

Allows you to choose between optimizing on accuracy or speed of simulation when digital components are included in your circuit. For details, see “9.3.7 Digital Simulation” on page 9-11.

### **A.1.5.6 Simulate/Analyses**

Some versions of Multisim do not include all of the analyses noted below.



Contains commands you use to set up and run the circuit’s analysis. For details on these analyses, see Chapter 11, “Analyses”.

Some analyses are not available in all versions of Multisim.

#### **Simulate/Analyses/DC Operating Point**

Sets up and runs DC operating point analysis, which determines the DC operating point of a circuit. For details, see “11.4 DC Operating Point Analysis” on page 11-31.

#### **Simulate/Analyses/AC Analysis**

Sets up and runs AC analysis, in which the DC operating point is first calculated to obtain linear, small-signal models for all nonlinear components. Then a complex matrix (containing both real and imaginary components) is created. For details, see “11.5 AC Analysis” on page 11-35.

#### **Simulate/Analyses/Transient Analysis**

Sets up and runs Transient analysis, also called time-domain transient analysis, which computes the circuit’s response as a function of time. For details, see “11.6 Transient Analysis” on page 11-38.

### **Simulate/Analyses/Fourier Analysis**

Sets up and runs Fourier analysis, which evaluates the DC, fundamental and harmonic components of a time-domain signal. For details, see “11.7 Fourier Analysis” on page 11-41.

### **Simulate/Analyses/Noise Analysis**

Sets up and runs Noise analysis, which is used to detect the magnitude of noise power in the output of electronic circuits. For details, see “11.8 Noise Analysis” on page 11-44.

### **Simulate/Analyses/Noise Figure Analysis**

This analysis is part of Multisim’s RF Design module (standard in the Power Professional edition, optional in the Professional edition) and is described in “15.4.3 Noise Figure Analysis” on page 15-25.

### **Simulate/Analyses/Distortion Analysis**

Sets up and runs Distortion analysis, which measures harmonic distortion and intermodulation distortion products. For details, see “11.9 Distortion Analysis” on page 11-51.

### **Simulate/Analyses/DC Sweep**

Sets up and runs DC sweep analysis, which computes the DC operating point of a node in the circuit for various values of one or two DC sources in the circuit. For details, see “11.10 DC Sweep Analysis” on page 11-59.

### **Simulate/Analyses/Sensitivity**

Sets up and runs Sensitivity analysis, which calculates the sensitivity of an output node voltage or current with respect to the parameters of all components (DC sensitivity) or one component (AC sensitivity) in a circuit. For details, see “11.11 DC and AC Sensitivity Analyses” on page 11-65.

### **Simulate/Analyses/Parameter Sweep**

Sets up and runs Parameter Sweep analysis, which verifies the operation of a circuit by simulating it across a range of values for a component parameter. For details, see “11.12 Parameter Sweep Analysis” on page 11-71.

### **Simulate/Analyses/Temperature Sweep**

Sets up and runs Temperature Sweep analysis, which quickly verifies the operation of a circuit by simulating it at different temperatures. The effect is the same as simulating the circuit several times, once for each different temperature. You control the temperature values. For details, see “11.13 Temperature Sweep Analysis” on page 11-80.

---

## **Simulate/Analyses/Pole Zero**

Sets up and runs Pole Zero analysis, which finds the poles and zeros in the small-signal AC transfer function of a circuit. For details, see “11.16 Pole Zero Analysis” on page 11-96.

## **Simulate/Analyses/Transfer Function**

Sets up and runs Transfer Function analysis, which calculates the DC small-signal transfer function between an input source and two output nodes (for voltage) or an output variable (for current) in a circuit. It also calculates input and output resistances. For details, see “11.14 Transfer Function Analysis” on page 11-83.

## **Simulate/Analyses/Worst Case**

Sets up and runs Worst Case analysis, a statistical analysis that lets you explore the worst possible effects on circuit performance of variations in component parameters. For details, see “11.15 Worst Case Analysis” on page 11-89.

## **Simulate/Analyses/Monte Carlo**

Sets up and runs Monte Carlo analysis, a statistical analysis that lets you explore how changing component properties affects circuit performance. For details, see “11.17 Monte Carlo Analysis” on page 11-103.

## **Simulate/Analyses/Trace Width Analysis**

Sets up and runs Trace Width analysis, which calculates the minimum trace width needed in a circuit to handle the peak current to be carried by that trace. For details, see “11.18 Trace Width Analysis” on page 11-115.

## **Simulate/Analyses/Batched Analyses**

Sets up and runs batched analyses, which let you set up a series of different analyses, or different variations on the same analysis, to be performed on a circuit in sequence. For details, see “11.21 Batched Analyses” on page 11-123.

## **Simulate/Analyses/User Defined Analysis**

Sets up and runs a user-defined analysis. This command presents you with a dialog box into which you can type the SPICE commands to be executed to perform the analysis. For details, see “11.22 User Defined Analyses” on page 11-124.

## **Simulate/Analyses/Stop Analysis**

Stops the currently running analysis.

## Simulate/Analyses/RF Analyses

Since RF analyses are available from the Network Analyzer instrument, this command places the Network Analyzer for you. For details, see “15.3.2 Network Analyzer” on page 15-15.

### A.1.5.7 Simulate/Postprocessor

Opens the **Postprocessor** dialog box, which you use to combine the results of several analyses in different ways. To use the **Postprocessor**, you must have performed at least one analysis on your circuit. For details, see Chapter 12, “Postprocessor”.

### A.1.5.8 Simulate/Simulation Error Log/Audit Trail

Shows or hides the simulation log, which records all the events of a circuit simulation. For details about this log, see “9.8 Simulation Adviser” on page 9-26.

### A.1.5.9 Simulate/XSpice Command Line Interface

Opens a window into which you can type Xspice commands to be executed. For details, see “9.2.3 Simulation from Netlist Without Schematic” on page 9-6.

### A.1.5.10 Simulate/Load Simulation Settings

Use to load a set of simulation settings that you saved earlier. For details, see “9.9.2 Loading a Simulation Profile” on page 9-28.

### A.1.5.11 Simulate/Save Simulation Settings

Use to save a set of simulation settings for later use. “9.9.1 Saving a Simulation Profile” on page 9-27.

### A.1.5.12 Simulate/VHDL Simulation

This feature is not available in all versions of Multisim.



Runs the optional MultiVHDL simulation software. This software is installed separately from its own CD. For details, see the documentation that is included with your MultiVHDL software.

### A.1.5.13 Simulate/Probe Properties

Displays the **Probe Properties** dialog box. For details, see “10.15.1.1 Measurement Probe Settings” on page 10-42.

---

### **A.1.5.14 Simulate/Reverse Probe Direction**

Reverses the polarity of a placed probe. For details, see “10.15 Measurement Probe” on page 10-40.

### **A.1.5.15 Simulate/Clear Instrument Data**

Clears simulation data from instruments like the oscilloscope. Does not clear the **Grapher**.

### **A.1.5.16 Simulate/Global Component Tolerances**

Multisim’s virtual components are, by default, “ideal”— they have no internal resistance and their output is consistent. You can choose to use global components instead. These randomly introduce variances to simulate the performance of actual, physical components. Global component settings affect the simulation results. See “7.4 Component Nominal Values and Tolerances” on page 7-7 for details.

## **A.1.6 Transfer Menu**

### **A.1.6.1 Transfer/Transfer to Ultiboard**

Displays a file browser where you choose or enter a file name for the data being transferred to Ultiboard. A netlist file for Ultiboard is created.

### **A.1.6.2 Transfer/Transfer to Other PCB Layout**

Displays a file browser where you choose or enter a file name for the transferred data. You can choose the appropriate file type from a list of available types.

### **A.1.6.3 Transfer/Forward Annotate to Ultiboard**

Forward annotates changes made to a circuit in Multisim to the Ultiboard circuit file. For details, see “14.3 Forward Annotation” on page 14-4.

### **A.1.6.4 Transfer/Backannotate from Ultiboard**

Backannotates changes made to a circuit in Ultiboard (for example, deleted components) to the Multisim circuit file. Displays a file browser where you choose the backannotation file corresponding to your circuit file. The circuit file must be open before you use this command. For details, see “14.4 Back Annotation” on page 14-5.

### A.1.6.5 Transfer/Highlight Selection in Ultiboard

When Ultiboard is running, and you have selected components in Multisim, the corresponding components are highlighted in Ultiboard.

### A.1.6.6 Transfer/Export Netlist

Exports the netlist of your design. Opens a standard file browser where you can choose the file name and folder for the exported netlist.

## A.1.7 Tools Menu

### A.1.7.1 Tools/Component Wizard

Invokes the **Component Wizard**, which takes you through the steps required to create a component. For details, see “8.2 Adding Components with the Component Wizard” on page 8-4.

**Note** The Tools menu is hidden when the simplified version option is selected. For details, see “1.3.1.2 Simplified Version (rfe)” on page 1-7.

### A.1.7.2 Tools/Database

#### Tools/Database/Database Manager

Lets you add component families, assign button icons to families, edit, copy and delete components, and (for some editions of Multisim) enter or modify user field titles for those component families. For details, see “7.5 Managing the Database” on page 7-8.

#### Tools/Database/Save Component to DB

Lets you save the selected component, including any changes you made to it, to the database. For details, see “7.5.6 Saving Placed Components” on page 7-16.

#### Tools/Database/Convert Database

Converts components in an existing **Corporate** or **User Database** into Multisim 9 format. For details, see “7.6 Converting 2001 or V7 Databases” on page 7-18.

#### Tools/Database/Merge Database

Displays the **Merge Database** dialog box where you can merge the contents of another database into your **User** or **Corporate Database**.

For details, see “7.8 Merging Databases” on page 7-20.

---

### A.1.7.3 Tools/Circuit Wizards/555 Timer Wizard

Lets you design astable or monostable timer circuits. For details, see “9.6.1 555 Timer Wizard” on page 9-14.

### A.1.7.4 Tools/Circuit Wizards/Filter Wizard

Lets you design Low Pass, High Pass, Band Pass and Band Reject filters. For details, see “9.6.2 Filter Wizard” on page 9-18.

### A.1.7.5 Tools/Circuit Wizards/Opamp Wizard

Lets you design the following opamp circuits: Inverting Amplifier; Non-inverting Amplifier; Difference Amplifier; Inverted Summing Amplifier; Non-inverted Summing Amplifier; Scaling Adder. For details, see “9.6.5 Opamp Wizard” on page 9-22.

### A.1.7.6 Tools/Circuit Wizards/CE BJT Amplifier Wizard

Lets you design common emitter amplifier circuits by entering the desired specifications into its fields. For details, see “9.6.3 Common Emitter BJT Amplifier Wizard” on page 9-19.

### A.1.7.7 Tools/Circuit Wizards/MOSFET Amplifier Wizard

Lets you design MOSFET amplifier circuits by entering the desired specifications into its fields. For details, see “9.6.4 MOSFET Amplifier Wizard” on page 9-21.

### A.1.7.8 Tools/Variant Manager



Displays the **Variant Manager** dialog box. For details, see “6.5 Variants” on page 6-34.

### A.1.7.9 Tools/Set Active Variant



Displays the **Active Variant** dialog box. For details, see “6.5 Variants” on page 6-34.

### A.1.7.10 Tools/Rename/Renumber Components

Lets you renumber components on the screen. This is useful if you have numbers that appear all over the screen, depending on where they were placed, or if you have numbers missing in a sequence. For details, see “6.3 Renaming Component Instances” on page 6-11.



### A.1.7.11 Tools/Replace Component

Before using, select the desired component(s) in the circuit window to be replaced. Invokes the **Select a Component** browser from which you can select a new component. Click **OK** to replace the old component(s) with the selected new one. See also, “4.4.7 Replacing a Placed Component” on page 4-17.

### A.1.7.12 Tools/Update Circuit Components

If you open a circuit that was created in an older version of Multisim, you can update its components to match the current database. For details, see “7.7 Updating Components from Databases” on page 7-19.

### A.1.7.13 Tools/Electrical Rules Check

Displays the **Electrical Rules Check** dialog box where you can create reports of electrical connection errors, such as an output pin connected to a power pin. For instructions on running the rule check, see “5.4 Electrical Rules Checking” on page 5-34.

### A.1.7.14 Tools/Clear ERC Markers

Clears ERC error markers from the workspace that were placed during earlier ERC runs. For instructions on running the rule check, see “5.4 Electrical Rules Checking” on page 5-34.

### A.1.7.15 Tools/Toggle NC Marker

Use to place a no connection (NC) marker on a selected pin, which prevents wires from being attached to that pin. For details, see “4.5.4 Marking Pins for No Connection” on page 4-23.

### A.1.7.16 Tools/Symbol Editor

Lets you create and edit component symbols. For details, see “8.5.2 Creating and Editing a Component’s Symbol with the Symbol Editor” on page 8-17.

### A.1.7.17 Tools/Title Block Editor



Lets you edit the appearance of, or create a new, title block. For details, see “5.3 Title Block Editor” on page 5-15.

### A.1.7.18 Tools/Description Box Editor

Displays the screen where you edit the contents of the **Circuit Description Box**. For details, see “4.10 Circuit Description Box” on page 4-47.

---

### **A.1.7.19 Tools/Edit Labels**

Lets you edit labels that you have inserted into the contents of the **Circuit Description Box**. For details, see “4.10.2.4 Edit Labels Dialog Box” on page 4-56.

### **A.1.7.20 Tools/Capture Screen Area**

Use to make a screen capture of a specific area of your screen. For details, see “4.9.7 Capturing Screen Area” on page 4-45.

### **A.1.7.21 Tools/Internet Design Sharing**

Use to communicate and share designs with others, either across a network or using the Internet. For details, see “14.8 Internet Design Sharing” on page 14-10.

## **A.1.8 Reports Menu**

### **A.1.8.1 Reports/Bill of Materials**



Lets you print a Bill of Materials (BOM) for your circuit. A BOM lists the components used in your design and provides a summary of the components needed to manufacture the circuit board. For details, see “13.1 Bill of Materials” on page 13-2.

### **A.1.8.2 Reports/Component Detail Report**

Lets you produce a report showing all information stored in the database for a particular component. For details, see “13.2 Component Detail Report” on page 13-5.

### **A.1.8.3 Reports/Netlist Report**

Lets you print a report that provides circuit connectivity information for each component. For details, see “13.3 Netlist Report” on page 13-6.

### **A.1.8.4 Reports/Cross Reference Report**

Lets you produce a detailed list of all components in the active circuit. For details, see “13.7 Cross Reference Report” on page 13-12.

### **A.1.8.5 Reports/Schematic Statistics**



Lets you print a report that lists the quantities of various elements in your circuit, such as real components, virtual components and nets. For details, see “13.4 Schematic Statistics Report” on page 13-8.

### **A.1.8.6 Reports/Spare Gates Report**



Lets you produce a report that lists the components in a circuit that have unused gates. For details, see “13.5 Spare Gates Report” on page 13-9.

## **A.1.9 Options Menu**

### **A.1.9.1 Options/Global Preferences**

Displays the **Preferences** dialog box. For details see “3.4.1 Using the Preferences Dialog Box” on page 3-20.

### **A.1.9.2 Options/Sheet Properties**

Displays the **Sheet Properties** dialog box. For details see “3.4.2 Using the Sheet Properties Dialog Box” on page 3-25.

### **A.1.9.3 Options/Customize User Interface**

Lets you tailor your interface to your personal preferences. For details, see “3.6 Customizing the Interface” on page 3-37.

## **A.1.10 Window Menu**

Contains commands used to control the display of Multisim windows. Lists all open circuit windows.

### **A.1.10.1 Window/New Window**

Creates a copy of the existing window.

### **A.1.10.2 Window/Cascade**

Arranges circuit windows so that they overlap.

---

### **A.1.10.3 Window/Tile Horizontal**

Resizes all open circuit windows so they all show on the screen in a horizontal orientation. Allows you to quickly scan all open circuit files.

### **A.1.10.4 Window/Tile Vertical**

Resizes all open circuit windows so they all show on the screen in a vertical orientation. Allows you to quickly scan all open circuit files.

### **A.1.10.5 Window/Close All**

Closes all open files.

### **A.1.10.6 Window/Windows**

Displays the **Windows** dialog box where you can show or close the files that you currently have open.

### **A.1.10.7 Window (open files)**

Lists the open Multisim circuit files. Select one to make it active.

## **A.1.11 Help Menu**

Contains commands that display online help and Multisim edition information.

**Tip** If you want to be able to refer to Help information as you work on a circuit, use the Keep Help on Top function in the Help window's Options menu.

### **A.1.11.1 Help/Multisim Help**

Displays the Multisim helpfile. The contents of this helpfile are identical to the contents of the chapters of this guide.

### **A.1.11.2 Help/Component Reference**

Displays Multisim's component reference helpfile. The contents of this helpfile are the same as the contents of the *Component Reference Guide*.

### **A.1.11.3 Help/Release Notes**

Displays edition information, additions or corrections to printed documentation, and other useful information.

### **A.1.11.4 Help/Check for Updates**

Runs the **Support and Upgrade Utility (SUU)**. For details, see “1.5 Support and Upgrade” on page 1-14.

### **A.1.11.5 Help/File Information**

Displays the **File Information** dialog box.

### **A.1.11.6 Help/About Multisim**

Displays information on the edition number of Multisim. Customer support may ask for this number.

# Index

## Numerics

555 Timer Wizard 9-14

## A

AC analysis 11-35

AC Motor model maker 8-65

AC sensitivity analysis 11-65

Add a Footprint dialog 8-57

Add Buslines dialog box 6-22

Add Variant Name dialog box 6-35

adding

    components 8-4

    device/model parameters 11-26

administering NLS 1-10

Advanced Pin Mapping dialog 8-58

Agilent Simulated Function Generator 10-71

Agilent simulated instruments 10-70

Agilent Simulated Multimeter 10-74

Agilent Simulated Oscilloscope 10-77

algorithm

    Gmin stepping 9-11

    source stepping 9-11

ammeter

    about 10-86

    connecting 10-87

    mode 10-87

    multimeter measurement options 10-11

    resistance 10-86

analyses

    about 11-4

    AC 11-35

    AC sensitivity 11-65

    analysis options tab 11-29

    Analysis Parameters tab 11-24

    audit trail 9-25

    batched 11-123

    cutting/copying/pasting pages, graphs, and  
        charts 11-20

    DC operating point 11-31

    DC sensitivity 11-65

    DC sweep 11-59

    determining component use 5-7

    distortion 11-51

    Fourier 11-41

    incomplete 11-30

    matching network 15-20

    Monte Carlo 11-103

    nested sweep 11-121

    noise 11-44

    options 11-129

    output tab 11-24

    parameter sweep 11-71

    performing (general instructions) 11-23

    pole zero 11-96

    printing graphs and charts 11-22

    results 9-25

    RF 15-18

    RF Characterizer 15-18

    summary tab 11-30

    temperature sweep 11-80

    trace width 11-115

    transfer function 11-83

    transient 11-38

    user-defined 11-124

    viewing charts 11-19

    viewing graphs 11-8

    working with pages 11-7

    worst case 11-89

Analysis Expression dialog box 11-27

analysis options 11-29, 11-129

Analysis Options dialog 11-129

analysis options tab, about 11-29

analysis output, manipulating 12-2

Analysis Parameters tab, about 11-24

audit trail 9-25

automatic wiring 4-19

axes, Bode plotter settings 10-25

---

## B

- back annotation 14-5
- backing up projects 6-51
- batched analyses 11-123
- Bill of Materials 13-2
- bill of materials
  - about 2-12
- BJT model maker 8-65
- Bode plotter
  - about 10-23
  - axes settings 10-25
  - magnitude 10-25
  - phase 10-25
  - readouts 10-27
  - settings 10-25
- BOM report
  - using 13-3
- Boolean expressions, entering 10-37
- Boost Converter model maker 8-78
- Browser screen 4-4
- browsing database 4-3
- BSPICE model 8-48
- Buck Boost Converter model maker 8-79
- Buck Converter model maker 8-79
- bus
  - placing 6-16
- Bus Entry Connection dialog box 6-25, 6-26
- Bus Merge dialog box 6-24
- Bus Properties dialog box 6-21
- Bus Vector Connect A-13
- Bus Vector Connect dialog 6-27
- bus width 3-29
- Buses 6-16
  - placing 6-18
- Button Appearance dialog 3-42

## C

- capturing screen area 4-46
- CE BJT Wizard 9-19
- changing component value/model 5-3
- channel settings 10-21
- chart

- properties 11-19
- charts
  - cut/copy/paste 11-20
  - printing 11-22
  - using in postprocessor 12-8
  - viewing 11-19
- checking electrical connections 5-34
- circuit
  - adding instruments to 10-5
  - consistency, checking in simulation 9-5
  - equation 9-9
  - printing files 4-63
  - simulation mechanism 9-6
- circuit window
  - multiple 4-3
  - placing components 4-4
- clock
  - logic analyzer 10-33
- Clock Setup dialog 10-34
- code model
  - about 8-111
  - creating 8-112
  - implementation file 8-121
  - interface file 8-115
- color
  - component 4-18
  - customizing 3-26
  - selecting 3-26
  - wire 4-27
- command line 9-6
- component
  - properties, General tab 8-14
  - symbol, editing 8-15
  - value/model, changing 5-3
- Component Browser 4-4
- Component Detail Report
  - dialog box 13-5
- Component Detail report
  - using 13-5
- Component Editing
  - about 8-2
- Component List dialog 8-42

---

component wizard 8-4  
component's properties dialog 4-17  
    Variant tab 6-39  
components  
    about 7-1  
    adding 8-4  
    changing value/model 5-3  
    classification in database 7-3  
    color 4-18  
    copying 7-14  
    copying placed 4-16  
    copying symbols 8-16  
    creating model 8-38  
    detail report 13-5  
    determining use in analyses 5-7  
    displaying information 5-2  
    editing 8-12  
    editing model 8-38  
    editing symbol 8-15  
    finding 4-32  
    flipping 4-31  
    general properties 8-14  
    information stored 7-6  
    moving 4-15  
    package information 8-51  
    pins 8-51  
    placed, properties 5-2  
    placing 4-4  
    placing on circuit window 4-4  
    removing 7-13  
    rotating 4-30  
    user fields 8-63  
    using global 7-8  
    virtual 4-4  
    wiring 4-18  
connecting  
    ammeter 10-87  
    voltmeter 10-86  
connector, adding 4-29  
convergence assistance 9-11  
Convert Database dialog 7-18  
converting V6 database 7-18  
converting V7 database 7-18  
copying  
    component symbol 8-16  
    components 7-14  
    placed components 4-16  
creating  
    components 8-4  
    projects 6-48  
Cross Reference report 13-12  
    using 13-12  
Cuk Converter model maker 8-80  
Customization  
    other options 3-43  
Customize dialog  
    Commands tab 3-38  
    Keyboard tab 3-40  
    Menu tab 3-41  
    Options tab 3-42  
    pop-up menus 3-42  
    Toolbars tab 3-39  
customizing interface 3-20  
cut/copy/paste pages, graphs, and charts 11-20

**D**  
data ready 10-31  
database  
    adding a component family 7-11  
    browsing for components 7-4  
    component classification 7-3  
    deleting a component family 7-12  
    finding components 7-3  
    levels 7-2  
    loading a component toolbar button 7-11  
    management 7-8  
    searching for components 7-4  
    selecting components 4-3  
    structure of 7-2  
    V6 conversion 7-18  
    V7 conversion 7-18  
Database Information dialog box 7-17  
database levels 7-2  
Database Management dialog 7-9



---

Date and Time dialog 4-49  
DC operating point analysis 11-31  
DC sensitivity analysis 11-65  
DC sweep analysis 11-59  
default analysis, postprocessor 12-7  
Delete Multi-Page dialog 6-3  
deleting  
    component family 7-12  
    components 7-13  
    empty component families 7-12  
Description Label dialog 4-55  
Description window 4-47  
description, adding to circuit 4-47  
design sharing 14-10  
Design Toolbox  
    Hierarchy tab 6-44  
difference amplifier 9-23  
diode model maker 8-80  
displaying information about placed components  
    5-2  
distortion analysis 11-51  
Distortion Analyzer  
    Settings dialog 10-39  
distortion analyzer 10-38  
    harmonic distortion 10-39  
    SINAD 10-39  
dual-channel oscilloscope 10-19  
Duplicate Component Name dialog 7-18

## **E**

Edit footprint dialog 5-6  
Edit Forms dialog box 4-59  
Edit Labels dialog 4-56  
Edit menu A-4  
Edit Model dialog 5-5  
editing  
    component symbol 8-15  
    component toolbar button 7-11  
    components 8-12  
Electrical Rules Checking 5-34  
Electronic Parameters 8-62  
ERC markers, clearing 5-38

ERC Options tab 5-37  
ERC Rules tab 5-39  
error log/audit trail 9-25  
Excel, exporting simulation results to 14-5  
exporting  
    simulation results to Excel 14-5  
    simulation results to MathCAD 14-5  
exporting a netlist 14-7  
exporting simulation results 14-5  
exporting to Excel 14-6  
exporting to MathCAD 14-5

## **F**

File menu A-1  
File Properties dialog 6-51  
files  
    adding to project 6-48  
    locking and unlocking 6-50  
    opening with project 6-49  
    removing from project 6-49  
filter nodes 11-25  
Filter Wizard 9-18  
Find Component dialog 4-32  
Finding components 4-32  
finding components 4-32  
finding components in database 7-3  
Flat multi-sheet design 6-2  
flipping components 4-31  
font settings 3-30  
Footprint tab 8-51  
forms  
    about 4-59  
forward annotation 14-4  
Four Channel Oscilloscope 10-47  
Fourier analysis 11-41  
frequency 10-31  
Frequency Counter 10-57  
function generator  
    about 10-14  
    signal options 10-16

---

## G

- general component properties 8-14
- General tab 8-14
- Global Component Tolerance dialog 7-7
- global components, using 7-8
- Gmin stepping 9-11
- Graph properties
  - axis tabs 11-15
  - general tab 11-9
  - traces tab 11-16
- Grapher 11-4
- Grapher window 11-4
- Graphic Annotation 3-10, 4-43
- Graphic Annotation Toolbar 3-10
- Graphics
  - placing A-14
- graphs
  - about Grapher window 11-4
  - cut/copy/paste 11-20
  - printing 11-22
  - using in post processor 12-8
  - viewing 11-8
- grid
  - showing 3-28
- grounding oscilloscope 10-20

## H

- harmonic distortion
  - distortion analyzer 10-39
- HB/SC connector
  - placing A-12
- hidden pin 8-8, 8-15
- hidden pins 4-19
- Hierarchical Block
  - creating new 6-7, A-13
  - placing A-13
- Hierarchical Block Properties dialog 6-7
- Hierarchy tab
  - Variants folder 6-45
- horizontal Bode plotter settings 10-25

## I

- Ideal Transformer (mult. winding) model maker 8-84
- implementation file (code model) 8-121
- importing
  - files, other formats 14-8
  - model 8-48
  - SPICE, PSpice netlist 14-9
- In Use list 4-13
- incomplete analyses 11-30
- information stored for components 7-6
- in-place edit mode 8-26
- Insert Object dialog 4-50
- instruments
  - adding to a circuit 10-5
  - ammeter 10-86
  - Bode plotter 10-23
  - distortion analyzer 10-38
  - function generator 10-14
  - logic analyzer 10-31
  - logic converter 10-35
  - measurement options 10-11
  - multimeter 10-10
  - multiple 10-6
  - oscilloscope 10-19
  - spectrum analyzer 10-40
  - using 10-5
  - voltmeter 10-85
  - wattmeter 10-17
  - word generator 10-28
- integration order, maximum 9-10
- interactive simulation 9-3
- Interactive Simulation Settings 10-8
- interdigital model 15-38
- interface
  - customizing 3-20
  - elements 3-3
  - toolbars 3-4
- interface file (code model) 8-115
- internal settings of multimeter 10-13
- internet design sharing 14-10
- inverting amplifier 9-22

---

inverting summing amplifier 9-23

IV Analyzer 10-60

    Simulate Parameters dialog 10-63

## J

junction, adding 4-29

## L

labeling 4-33

labels

    assigning to nets 4-35

LabVIEW instruments 10-87

    creating 10-90

    microphone 10-89

    signal analyzer 10-90

    signal generator 10-90

    speaker 10-89

levels

    of database 7-2

Linear Transformer (mult. winding) model maker

    8-85

Linear Transformer (neutral terminal) model

    maker 8-86

loading model 8-48

locking files 6-50

logic analyzer

    about 10-31

    adjusting clock 10-33

    reset 10-33

    stop 10-33

    triggering 10-34

logic converter 10-35

    constructing a truth table 10-37

    deriving truth table from a circuit 10-36

    entering Boolean expressions 10-37

lossy line model 15-37

## M

magnitude 10-25

managing families 7-11

manual wiring 4-22

matching network analyses 15-20

MathCAD, exporting simulation results to 14-5

maximum integration order 9-10

measurement options

    ammeter 10-11

    ohmmeter 10-12

Measurement Probe 10-40

    dynamic connection 10-40, 10-44

    placed connection 10-45

    settings 10-42

    static connection 10-40

menu

    Edit A-4

    File A-1

    Options A-27

    Place A-12

    pop-up 3-12

    Reports A-26

    Simulate A-15

    Symbol Editor 8-27

    Tools A-23

    Transfer A-22

    View A-8

    Window A-27

microstrip line model 15-32

microstrip open end model 15-33

mode

    ammeter 10-87

    voltmeter 10-86

model

    changing component 5-3

    creating See model creation

    loading 8-48

model creation

    by importing 8-48

    using code modeling 8-111

Model Data report 13-11

    using 13-11

model maker

    AC Motor 8-65

    BJT 8-65

    Boost Converter 8-78

- 
- Buck Boost Converter 8-79
  - Buck Converter 8-79
  - Cuk Converter 8-80
  - diode 8-80
  - Ideal Transformer (mult. winding) 8-84
  - Linear Transformer (mult. winding) 8-85
  - Linear Transformer (neutral terminal) 8-86
  - Non-linear Transformer (mult. winding) 8-88
  - silicon controlled rectifier 8-102
  - Two Winding Linear Transformer 8-87
  - module
    - RF 15-2
  - Monte Carlo analysis 11-103
  - MOSFET Amplifier Wizard 9-21
  - moving component 4-15
  - multimeter 10-10
    - internal settings of 10-13
    - signal mode 10-13
    - using ammeter measurement option 10-11
    - using ohmmeter measurement option 10-12
  - Multimeter Settings dialog 10-14
  - multiple circuit windows 4-3
  - multiple instruments 10-6
  - multiple traces, postprocessor 12-8
- N**
- nested sweep analysis 11-121
  - Net dialog 4-35
  - Netlist report 13-6
    - using 13-7
  - Netmeeting 14-10
  - nets, assigning labels 4-35
  - network analyzer 15-15
  - Network License Server 1-10
  - New Family Name dialog 7-11
  - New Project dialog 6-48
  - NLS 1-10
  - noise analysis 11-44
  - Noise Figure Analysis 15-25
  - non-inverting amplifier 9-22
  - non-inverting summing amplifier 9-24
  - Non-linear Transformer (mult. winding) model
    - maker 8-88
- O**
- Off-page connector
    - placing 6-2, A-12
  - ohmmeter 10-12
  - Opamp Wizard 9-22
  - opening
    - file within project 6-49
    - project 6-49
  - Options dialog 4-50
  - Options menu A-27
  - options, analysis 11-129
  - oscilloscope
    - about 10-19
    - channel settings 10-21
    - grounding 10-20
    - time base 10-20
    - trigger 10-22
  - output tab, about 11-24
- P**
- package information 8-51
  - page bounds, showing 3-28
  - Page Name dialog 6-2
  - page properties 11-7
  - pages
    - cut/copy/paste 11-20
    - using in analyses 11-7
    - using in postprocessor 12-8
  - Paragraph dialog 4-48
  - parameter sweep analysis 11-71
  - Paste Special dialog 4-16
  - PCB layout, transfer to 14-4
  - phase 10-25
  - pin information 8-51
  - pin parameters 8-50
  - pins, adding to symbols 8-23
  - Place menu A-12
  - placed components, properties 5-2
  - Placed Probe 10-41

---

placing  
    multi-page 6-2  
Placing a bus 6-18  
placing components 4-4  
pole zero analysis 11-96  
pop-up  
    from selected wire 3-17  
    from title block 3-18  
pop-up menu 3-12  
    from selected component 3-15  
    no component selected 3-13  
postprocessor  
    about 12-2, 12-9  
    basic steps 12-2, 12-5  
    creating multiple traces 12-8  
    functions 12-10  
    pages, graphs and charts 12-8  
    screen 12-3  
    using the default analysis 12-7  
    variables 12-9  
Power Pro  
    using code modeling 8-111  
pre-defined fields in database 7-6  
preferences  
    General tab 3-24  
    Preferences dialog 3-20  
    Sheet Properties dialog 3-25  
Preferences Dialog  
    Parts tab 3-23  
    Paths tab 3-21  
    Save tab 3-22  
print  
    circuit setup A-3  
    setup A-3  
Print Circuit Setup dialog 4-62  
Print Instruments dialog 10-7  
printing  
    circuit files 4-63  
    graphs and charts 11-22  
printing instruments 10-7  
Probe Properties dialog 10-42  
project  
    adding files to 6-48  
    backing up 6-51  
    creating 6-48  
    opening 6-49  
    removing files from 6-49  
    saving 6-49  
Project bar 6-48  
project management, about 6-47  
Projects  
    working with 6-49  
properties  
    workspace tab 3-28  
properties of placed components 5-2

**Q**  
questions  
    creating 4-59  
    linking to a circuit 4-59  
    setting submit options 4-61

**R**  
readouts 10-27  
Recent Circuits A-4  
Reference Designator Prefix Setup dialog 6-13  
Refine Search Component dialog 7-6  
release notes A-29  
remote control 14-10  
removing components 7-13  
Rename Busline dialog box 6-23  
Rename Variant dialog box 6-35, 6-36  
replacing components with a subcircuit 6-11  
reports  
    Bill of Materials 13-2  
    bill of materials 2-12  
    component detail 13-5  
Reports menu A-26  
resistance  
    ammeter 10-86  
    voltmeter 10-85  
RF analyses 15-18  
RF characterizer analysis 15-18  
RF components

---

- about 15-2
- interdigital model 15-38
- lossy line model 15-37
- microstrip line model 15-32
- microstrip open end model 15-33
- RF model makers 15-31
- RF spiral inductor model 15-34
- strip line model 15-35
- stripline bend model 15-36
- waveguide model 15-31
- RF instruments
  - network analyzer 15-15
  - spectrum analyzer 15-9
- RF module 15-2
  - about 15-2
  - components (*see also* RF components) 15-2
  - instruments (*see also* RF instruments) 15-9
- RF simulation 9-12, 9-13
- RF tutorial 15-39
- rotating components 4-30
- Rule Check tab 5-39

**S**

- saving
  - project 6-49
- scaling adder 9-24
- schematic capture 4-3
- Schematic Statistics report 13-8
  - using 13-8
- Search Component dialog 7-4
- Search Component Result dialog 7-5
- search results 7-5
- Select a Component browser 4-17
  - other buttons 4-9
  - using 4-4
- Select a Footprint dialog 8-52
- Select a Model dialog 8-41
- Select Model Data dialog 8-49
- Select Model Maker dialog 8-43
- Set Parameters dialog 8-41, 8-52
- settings, oscilloscope channel 10-21
- Sheet Properties
  - Circuit tab 3-26
- Sheet Properties dialog
  - Font tab 3-30
  - PCB tab 3-32
  - Visibility tab 3-33
  - Wiring tab 3-29
  - Workspace tab 3-28
- sheet size 3-28
- show
  - grid 3-28
  - page bounds 3-28
  - title block 3-28
- signal mode 10-13
- signal options 10-16
- silicon controlled rectifier model maker 8-102
- Simulate menu A-15
- simulation
  - checking circuit consistency 9-5
  - circuit 9-6
  - circuit equation 9-9
  - Gmin stepping 9-11
  - interactive 9-3
  - maximum integration order 9-10
  - RF 9-12, 9-13
  - source stepping 9-11
  - stages of 9-7
  - starting and stopping 9-4
- Simulation Adviser 9-26
- simulation errors
  - troubleshooting 10-9
- simulation speed 9-4
- SINAD 10-39
- source stepping 9-11
- Spare Gates report 13-9
  - using 13-10
- spectrum analyzer 10-40, 15-9
- SPICE simulation
  - circuit 9-6
  - circuit equation 9-9
  - Gmin stepping 9-11
  - maximum integration order 9-10
  - source stepping 9-11

---

- spiral inductor, RF 15-34
- Spreadsheet view 5-9
  - Components tab 5-11
  - Nets tab 5-10
  - PCB Layers tab 5-14
- strip line model 15-35
- stripline bend model 15-36
- structure of database 7-2
- subcircuit
  - replacing components with 6-11
- Subcircuit Name dialog 6-9
- summary tab, about 11-30
- Support and Upgrade Utility 1-14
- SUU 1-14
- SUU settings 1-16
- symbol
  - adding pins 8-23
  - copying 8-16
  - editing 8-15
  - shape 8-22
- Symbol Editor
  - Default Pin Options dialog 8-24
  - Draw Tools toolbar 8-35
  - Drawing toolbar 8-37
  - Edit menu 8-28
  - Enter Text dialog 8-26
  - File menu 8-27
  - Graphics menu 8-31
  - Help menu 8-32
  - in-place edit mode 8-26
  - Layout menu 8-32
  - menus 8-27
  - palette 8-33
  - Pin Array Options dialog 8-25
  - Pins menu 8-30
  - Place Pin toolbar 8-36
  - pop-up menus 8-33
  - screen 8-18
  - Spreadsheet view 8-19
  - Spreadsheet view, Draw Layer tab 8-21
  - Spreadsheet view, Pins tab 8-19
  - Standard toolbar 8-33

- symbol pins 8-22
- symbol shape 8-22
- Tool menu 8-32
- toolbars 8-33
  - using 8-17
- View menu 8-29
  - working with 8-22
- Zoom toolbar 8-34

system toolbar 3-5

## T

- Tabs dialog 4-49
- Tektronix Simulated Oscilloscope 10-82
- temperature sweep analysis 11-80
- the 1-16
- time base 10-20
- Title Block
  - adding 4-36
  - contents, editing 4-37
  - placing A-15
  - showing 3-28
- Title Block Editor 5-15
  - Draw Tools toolbar 5-31
  - Drawing toolbar 5-32
  - Edit menu 5-23
  - Enter Text dialog 5-17
  - Enter Title Block Attribute dialog 5-18
  - field codes 5-20
  - Fields menu 5-25
  - File menu 5-22
  - Graphics menu 5-27
  - Help menu 5-28
  - menus 5-22
  - pop-up menus 5-28
  - Spreadsheet View 5-21
  - Standard toolbar 5-29
  - Toolbars 5-29
  - Tools menu 5-28
  - View menu 5-24
  - Zoom toolbar 5-30
- tolerances 7-8
- toolbars 3-4

---

- system 3-5
- zoom 3-5
- Tools menu A-23
- trace width analysis 11-115
- transfer function analysis 11-83
- Transfer menu A-22
- transfer to other PCB Layout 14-4
- transfer to Ultiboard PCB Layout 14-3
- transfer/communication functions, introduction to 14-2
- transferring data 14-2
- transferring, from Multisim to Ultiboard 14-3
- transferring, multi-section components to PCB layout 14-4
- transient analysis 11-38
- Trigger Settings dialog 10-34
- trigger, oscilloscope 10-22
- triggering
  - logic analyzer 10-34
  - word generator 10-30
- troubleshooting simulation 10-9
- truth table
  - constructing 10-37
  - deriving from circuit 10-36
- Two Winding Linear Transformer model maker 8-87

## U

- Ultiboard, transfer to 14-3
- Ulticap Import dialog 14-8
- unlocking files 6-50
- updates 1-14
- Updating components 7-19, A-25
- user field titles, modifying 7-12
- user fields 7-7
  - working with 8-63
- user interface
  - customizing 3-20
  - elements 3-3
  - toolbars 3-4
- user-defined analysis 11-124
- using instruments 10-5

- using model makers 8-64

## V

- value, changing component 5-3
- variables, postprocessor 12-9
- Variant Manager dialog 6-34
- Variant tab 6-39
- variants 6-34
  - Variant Manager dialog 6-34
- Variants Filter dialog box 13-13
- Variants folder 6-45
- version control
  - about 6-47
  - using 6-51
- Version Control dialog 6-51
- vertical Bode plotter settings 10-25
- View menu A-8
- virtual components 4-4
- virtual wiring 4-28
- voltmeter
  - about 10-85
  - connecting 10-86
  - mode 10-86
  - resistance 10-85

## W

- wattmeter 10-17
- waveguide model 15-31
- Window menu A-27
- Windows dialog box A-28
- wire
  - color 4-27
  - re-shaping 4-27
  - width 3-29
- wiring
  - "mid-air" 4-26
  - automatic 4-19
  - combining automatic and manual 4-23
  - components 4-18
  - directly onto workspace 4-26
  - manual 4-22



---

- properties 4-26
- setting options 3-29
- virtual 4-28
- width 4-26

#### Wizard

- 555 Timer 9-14
- Common Emitter BJT 9-19
- Component 8-4
- Filter 9-18
- MOSFET Amplifier 9-21
- Opamp 9-22

word generator 10-28

- controls 10-29
- enabling data 10-31
- entering words 10-29
- setting clock frequency 10-31
- triggering 10-30
- using word patterns in 10-30

worst case analysis 11-89

## **X**

### XSPICE

- model 8-48

### Xspice

- command line 9-6

XSpice Command Line dialog 9-6

## **Z**

zoom level, default 3-28

zoom out A-8

zoom toolbar 3-5

zoom, setting 3-28

# Technical Support and Professional Services

---

Visit the following sections of the National Instruments Web site at [ni.com](http://ni.com) for technical support and professional services:

- **Support**—Online technical support resources at [ni.com/support](http://ni.com/support) include the following:
  - **Self-Help Resources**—For answers and solutions, visit the award-winning National Instruments Web site for software drivers and updates, a searchable KnowledgeBase, product manuals, step-by-step troubleshooting wizards, thousands of example programs, tutorials, application notes, instrument drivers, and so on.
  - **Free Technical Support**—All registered users receive free Basic Service, which includes access to hundreds of Application Engineers worldwide in the NI Developer Exchange at [ni.com/exchange](http://ni.com/exchange). National Instruments Application Engineers make sure every question receives an answer.  
  
For information about other technical support options in your area, visit [ni.com/services](http://ni.com/services) or contact your local office at [ni.com/contact](http://ni.com/contact).
- **Training and Certification**—Visit [ni.com/training](http://ni.com/training) for self-paced training, eLearning virtual classrooms, interactive CDs, and Certification program information. You also can register for instructor-led, hands-on courses at locations around the world.
- **System Integration**—If you have time constraints, limited in-house technical resources, or other project challenges, National Instruments Alliance Partner members can help. To learn more, call your local NI office or visit [ni.com/alliance](http://ni.com/alliance).

If you searched [ni.com](http://ni.com) and could not find the answers you need, contact your local office or NI corporate headquarters. Phone numbers for our worldwide offices are listed at the front of this manual. You also can visit the Worldwide Offices section of [ni.com/niglobal](http://ni.com/niglobal) to access the branch office Web sites, which provide up-to-date contact information, support phone numbers, email addresses, and current events.